



INVEST IN THE FUTURE



French manufacturer
since 1964

Car Body Welding Systems

Catalogue Carrosserie

Catalogo Carrozzeria

Karosserie-Schweißtechnik Katalog

Catálogo de Soldadura para Carrocería

2
0
2
1



- SPOTTER
- DENT PULLER
- MIG
- PLASMA
- INDUCTION
- LIFT
- RIVETING
- ACCESSORIES



GYS FRANCE
Laval

🕒 1964
👤 × 530

Created in 1964, GYS is a French industrial group with 770 employees around the world. Built around continuous investment in Research & Development and in the acquisition of knowledge, the company is now a major player in the design and manufacture of welding machines, battery chargers and car body repair equipment.

“ The market realities are constantly changing and the size of our family business requires us to quickly adapt to new contexts and new challenges.

We are convinced that our future is closely linked to the future of our partners. This is why we do everything in our power to understand what distributors and users expect from us and what challenges they face every day. To support them in facing these challenges, we wish to become and remain their privileged partner on the path we will travel together. ”

Bruno Bouygues,
C.E.O.



Nicolas & Bruno Bouygues

A worldwide coverage

125 countries



visit with
Youtube

INVEST IN THE FUTURE

FR

Créé en 1964, GYS est un groupe industriel français regroupant plus de 770 collaborateurs dans le monde. Fort d'un centre de recherche de premier plan, GYS est un acteur majeur dans la conception et la fabrication d'équipements de soudage, de chargeurs de batteries et de systèmes de réparation carrosserie.

Les nouvelles réalités du marché sont en perpétuel changement et la taille de notre entreprise familiale nous impose une adaptation rapide aux nouveaux contextes et à leurs enjeux.

Nous sommes convaincus que notre avenir est étroitement lié à celui de nos clients. Pour cela, nous mettons tout en oeuvre pour comprendre ce que les distributeurs et les utilisateurs attendent de nous, savoir à quels défis ils font face et voir dans quelle mesure nous pouvons leur permettre de les relever afin de devenir et rester leur partenaire privilégié pour le chemin que nous avons à parcourir ensemble.

DE

GYS wurde 1964 gegründet und ist ein französisches Familienunternehmen mit mehr als 770 Mitarbeitern auf der ganzen Welt. Dank einem erstklassigen Forschungszentrum ist GYS ein wichtiger Akteur in der Entwicklung und Herstellung von Schweißgeräten, Batterieladegeräten und Karosseriereparatursystemen.

Neue Marktbedingungen sind in fortwährender Veränderung und die Größe unseres Familienunternehmens veranlasst eine rasche Anpassung an neue Umstände und an ihre Herausforderungen.

Wir sind überzeugt, dass unsere Zukunft eng mit der unserer Kunden verbunden ist. Dafür setzen wir all unser Können ein, um zu verstehen, was die Händler und Anwender von uns erwarten, welchen Herausforderungen sie gegenüberstehen und um zu schauen, in welchem Maße wir sie unterstützen können, damit wir ihr bevorzugter Partner werden und bleiben auf dem Weg, den wir gemeinsam beschreiten.

IT

Nato nel 1964, GYS è un gruppo industriale francese che raggruppa oltre 770 collaboratori nel mondo. Forte di un centro di ricerca di grande importanza, GYS è uno dei maggiori protagonisti nella progettazione e fabbricazione di apparecchiature per la saldatura e il taglio, di cariche batterie booster e avviatori e sistemi di riparazione delle carrozzerie.

Le realtà del mercato sono in continuo cambiamento e richiedono risposte immediate. Le dimensioni della nostra impresa familiare consentono un adattamento rapido ai nuovi contesti e alle loro problematiche.

Siamo convinti che il nostro futuro sia strettamente legato a quello dei nostri clienti. Per questo noi mettiamo il massimo impegno per capire quello che i distributori e i loro clienti/utilizzatori si aspettano da noi, quali sfide devono affrontare e come possiamo aiutarli per farli crescere, per diventare e restare loro partner di riferimento per proseguire insieme sul cammino del successo.

👤
770 people

🏠
55 000 m²
590 000 sqf
2 factories

🇩🇪 GYS GERMANY
Aachen

🕒 2006
👤 × 70

🇬🇧 GYS U.K.
Rugby

🕒 2008
👤 × 35

🇨🇳 GYS CHINA
Shanghai

🕒 2004
👤 × 125

🇮🇹 GYS ITALIA
Venezia

🕒 2015
👤 × 15

Partners





GYS ACADEMY

Training centre dedicated to professionals

Centre de formation agréé

Trainingcenter für Profis

Centro di formazione dedicato ai professionisti

Ref. 52 53 0068153

3 catalogues

2700+ references



Welding & Cutting



Car body Welding Systems



Chargers, Boosters & Starters

DENT PULLING

NEW
GYSPOT
p.6

Accessories,
levelling bars
p.16

Workstations
p.20

Pulling systems
p.26

Paintless repair
p.32

MOBILE PNEUMATIC LIFT

NEW
SPOT LIFT
p.34

AUTO ROLL
& accessories
p.34

ERGO LIFT
& accessories
p.36

TROLLEY IW1
p.37

SPOT WELDING

Overview
p.38

Traditional

PORTASPOT
p.40

GYSPOT 32D
p.40

Inverter

GYSPOT 100R
p.41

GYSPOT BP & PTI
p.42

X & C Arms
p.46

Genius

NEW
GYSPOT G
p.48

G Arms
p.52

Consumables
& accessories
p.52

RIVETING

NEW
GYSPRESS
p.54

Accessories
& consumables
p.58

MIG WELDING

NEW
GYS AUTO
p.64

NEW
MULTIPEARL
p.66

NEW
AUTOPULSE
p.68

Helmets, accessories
& consumables
p.72

INDUCTION

NEW
GYSDUCTION
COMBIDUCTION
p.78

POWERDUCTION
p.80

PLASMA

CUTTER & EASYCUT
p.84

+ MORE

Windscreen repair p.86
Bumper repair p.88
Tools p.90
Wheel repair p.95
Working lights p.96
Working supports p.98
Safety protections p.100

CHARGERS & BSU

NEW
GYSFLASH & MORE
p.102

Advanced R&D

75



Metal work
Tôlerie
Blechbearbeitung



Painting & marking
Peinture & marquage
Lackierstraße



Electronics
Électronique
Elektronik



Mechanical
Mécanique
CNC-Bearbeitung



Transformers
Transformateurs
Transformatoren



Cable work
Filerie
Kabelkonfektionierung

Assembly
Montage/tests
Montage

100%
in house
production

www.gys.fr





GYSPOT

DENT PULLING

ACIER / STEEL / STAHL

- ▽ Étoiles - Stars - Ausbeulstern
- ⌋ Anneaux - Rings - Zugösen
- 〰 Filis ondulés - Wavy wires - Wellendraht
- ⌋ Rabattage d'impact - Impact shrinking - Glätten

OPTIONS

Consommables - Consumables p.10

Chariots - Trolleys p.20

- ▽ Étoiles - Stars - Ausbeulstern
- ⌋ Anneaux - Rings - Zugösen
- 〰 Filis ondulés - Wavy wires - Wellendraht
- ⌋ Rabattage d'impact - Impact shrinking - Glätten
- + ⌋ Rétreinte - Tempering - Temperieren

NEW



FIXED GUN

FIXED GUN

GYSPOT 2600

2600 A x1 **AUTOMATIC**

230V • 1~

052208

included

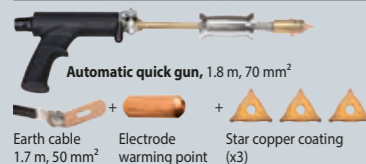

Earth cable 1.7 m, 50 mm² Electrode warming point Star copper coating (x3)

GYSPOT 2700

2600 A x1 **MANUAL**

230V • 1~

055353

included

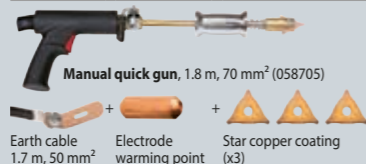

Earth cable 1.7 m, 50 mm² Electrode warming point Star copper coating (x3)

GYSPOT 34.02 & 34.04

3500 A x1 **MANUAL**

230V • 1~

GYSPOT 34.02
065741

400V • 2~

GYSPOT 34.04
067943

NEW
04 2021

NEW
04 2021

included

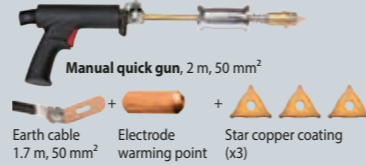

Earth cable 1.7 m, 50 mm² Electrode warming point Star copper coating (x3)

- ▽ Étoiles - Stars - Ausbeulstern
- ⌋ Anneaux - Rings - Zugösen
- 〰 Filis ondulés - Wavy wires - Wellendraht
- ⌋ Rabattage d'impact - Impact shrinking - Glätten
- + ⌋ Rétreinte - Tempering - Temperieren
- + ⌋ Rivets - Rivets - Nieten
- + ⌋ Rondelles - Rings - Unterlegscheiben
- + ⌋ Goujons - Studs - Gewindebolzen

SYNERGIC CONTROL

PATENTS REGISTERED NUMBERS EUROPEAN TRADEMARK & DESIGN



NEW DESIGN



NEW DESIGN



NEW DESIGN



GUN WITH CONNECTOR

GYSPOT 39.02 & 39.04

3800 A x1 **AUTOMATIC**

230V • 1~

GYSPOT 39.02
052215

400V • 2~

GYSPOT 39.04
052222

included



Earth cable 2 m, 70 mm² SPOTTER BOX STANDARD (053915) (Details p.10)

GYSPOT PRO 230 & PRO 400

3800 A x2 **AUTOMATIC**

230V • 1~

GYSPOT PRO 230
052178

400V • 2~

GYSPOT PRO 400
052185

included



Earth cable 2 m, 70 mm² SPOTTER BOX PRO (050075) (Details p.10)

GYSPOT EXPERT 200, 230 & 400

3800-4500 A x2 **AUTOMATIC**

230V • 1~

GYSPOT EXPERT 230
066885

200-240V • 1~

GYSPOT EXPERT 200
058842

400V • 2~

GYSPOT EXPERT 400
058859

ideal

included

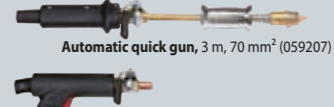

Earth cable Thick 3 mm 2 m, 70 mm² SPOTTER BOX PRO (050075) (Details p.10)

QUICK GUNS

Quick & Easy

AUTOMATIC



WITH CONNECTOR
cable 2 m, Ø 70 mm²
included 39.02/04
057517

included hammer:



WITH CONNECTOR
3 m, Ø 50 mm²
included PRO 230/400, COMBI 230EPRO
057500

WITH CONNECTOR
3 m, Ø 70 mm²
included EXPERT 200/230/400
059207

included hammer:



MANUAL



WITH CONNECTOR
cable 2 m, Ø 70 mm²
included PRO 230/400,
EXPERT 200/230/400,
COMBI 230EPRO
057524

included electrode warming point:



No connector
cable 1.8 m, Ø 70 mm²
for 2700
058705

included hammer:



PATENTS REGISTERED NUMBERS 001830845-0001 EUROPEAN TRADEMARK & DESIGN

MADE IN GYS CHINA	GYS NORM 62135	I ₂ max	U ₂	I _{AM}	I _{RMS}	kW	SYNERGIC	AUTOMATIC	MANUAL	SEPARATE CABLE GUN	SYNERGIC	AUTOMATIC	MANUAL	SEPARATE CABLE GUN	cm	kg	
																	50/60 Hz
MADE IN GYS CHINA	GYSPOT 2600	230V	2600	5,4	16	1800	10	OK	—	—	—	—	—	—	2 m	20 x 32 x 18	15
	GYSPOT 2700	230V	2600	5,4	16	1800	10	OK	—	—	—	—	—	—	2 m	20 x 32 x 18	14,5
	GYSPOT 34.02	230V	3500	7,4	16	2500	20	OK	OK	—	—	—	—	—	2 m	22,5 x 36 x 23,5	21
	GYSPOT 34.04	400V, 2ph	3500	7,4	16	2500	20	OK	OK	—	—	—	—	—	4 m	22,5 x 36 x 23,5	21
MADE IN FRANCE	GYSPOT 39.02	230V	3800	7,4	16	2800	20	OK	OK	—	—	—	—	—	4 m	22,5 x 36 x 23,5	22
	GYSPOT 39.04	400V, 2ph	3800	7,4	16	2800	20	OK	OK	—	—	—	—	—	4 m	22,5 x 36 x 23,5	22
	GYSPOT PRO 230	230V	3800	7,4	16	2800	20	OK	OK	—	—	—	—	—	8 m	22,5 x 36 x 23,5	20,5
	GYSPOT PRO 400	400V, 2ph	3800	7,4	16	2800	20	OK	OK	—	—	—	—	—	8 m	22,5 x 36 x 23,5	20,5
	GYSPOT EXPERT 200	200-240V	4350 > 5100	7,2-8,7	30(D)	3100 > 3600	25 > 36	OK	OK	—	—	—	—	—	8 m	22,5 x 36 x 23,5	33
	GYSPOT EXPERT 230	230V	3800	7,4	16	2800	20	OK	OK	—	—	—	—	—	8 m	22,5 x 36 x 23,5	20,5
	GYSPOT EXPERT 400	400V, 2ph	4500	7,4	16(D)	3200	25	OK	OK	—	—	—	—	—	8 m	22,5 x 36 x 23,5	28

GYSPOT

STEEL DENT PULLING



GYSPOT ALU

DENT PULLING

ALU

NEW DESIGN
COMING SOON

FV FLEXIBLE VOLTAGE

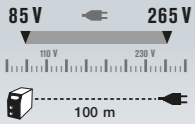

FIXED GUN

GYSPOT ALU PRO FV

100 · 230V · 1~

7500 A x1 AUTOMATIC

FV

021990

included



Automatic alu gun
3 m, 25 mm²

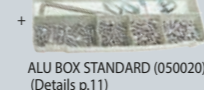

ALU BOX STANDARD (050020)
(Details p.11)

ALU GUN

AUTOMATIC

3 m, Ø 25 mm²

included ALU PRO FV
& COMBI 230
E.PRO



(x3)
065635

66 mF CAPACITOR
DISCHARGE
WELDING

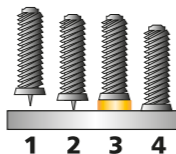

with connectors
for COMBI 230
E.PRO

PATENTS REGISTERED NUMBERS
002446450-0001
EUROPEAN TRADEMARK & DESIGN

OPTIONS

Consommables - Consumables
p.10



Accessoires ALU - ALU accessories
p.17



Chariots - Trolleys
p.20



GYSPOT COMBI

DENT PULLING

ALU + ACIER / STEEL / STAHL

NEW DESIGN
COMING SOON

3 GUNS INCLUDED



GUN WITH CONNECTOR

GYSPOT COMBI 230 E.PRO

230V · 1~

3800 A Acier / Steel / Stahl

7500 A Alu



AUTOMATIC

MANUAL

AUTOMATIC

021266

included

Automatic quick gun, 3 m, 50 mm² (057500)

Manual quick gun, 2 m, 70 mm² (057524)

Automatic alu gun, 3 m, 25 mm²

Earth cable
2 m, 70 mm²

SPOTTER BOX PRO (050075)
(Details p.10)

ALU BOX STANDARD (050020)
(Details p.11)

MADE IN FRANCE 62135	50/60 Hz	I ₂ max A	U ₂ V	I _{AM} A	I _{RMS} A	kW	MANUAL	SYNERGIC	AUTOMATIC	MANUAL	SEPARATE CABLE GUN	3 m	2 m	Included Alu box	21 x 24 x 36	12.5				
																	SYNERGIC	MANUAL	SEPARATE CABLE GUN	3 m
GYSPOT ALU PRO FV	110 · 230V	7500	50 · 200	5	—	0.65	OK	OK	■	■	—	■	x1	—	—	3 m	2 m	Included Alu box	21 x 24 x 36	12.5
GYSPOT COMBI 230 E.PRO	230V	3800 (steel) 7500 (alu)	7,4 (steel) 50 · 200 (alu)	16	2800 (steel)	20	OK	OK	—	■	■	■	x2	x1	■	2/3 m	8 m	Included Spotter box + Alu box	45 x 43 x 29	42.5

GYSPOT

ALU + STEEL DENT PULLING



ACIER / STEEL / STAHL



DENT BOX CONSUMABLES / BAR / EASY SPOTTER BOX STANDARD / 2600 / 2700



SPOTTER BOX PRO

hexagon	Earth plate small	chuck for inertia hammer	copper coating star	electrode ø 16 for 8 x 16	ø 8 x 16	earth hook	carbon heating electrode	electrode warming point ø 16	Ball electrode warming point Ø16	M8	elec-trode	wavy wire	magnetic positioner	elec-trode	straight rings	twisted rings	lifting rod	electrode for threaded studs rivets ø 5 - M5, M6	threaded M5 x 18 x 0.8	self-threading ø 5 x 18	ø 5 x 12	electrode ø 16, 3 x 4,50	ø 3 x 3,25	ø 3 x 4,50	electrode ø2 - M4	ø2	electrode wheel ø16	flat n°27	Earth plate large	magnetic
		x1	x20	x1	x100	x1	x5	x1	x1	x100	x1	x50	x1	x1	x100	x50	x3	x1	x100	x100	x100	x1	x100	x100	x1	x100	x1	x1	x1	x1
		049482	052239	049574	049444	056718	049468	049567	059726	049567	049789	049727	049772	050655	050648	050631	050792	049598	049383	049420	049413	049604	049345	049352	049277	041561	050310	049673	052529	049666

DENT BOX

BEST SELLER

CONSUMABLES 051515			x20				x25		x50		x25																					
BAR 050037	ideal PROLINER								x1		x25		x1		x50		x1		x180mm													
EASY 053632	included EASYLINER		x1	x1	x1	x10	x1	x50	x1	x1	x1	x1	x25	x1	x50	x1	x180mm															

SPOTTER BOX

PRO 050075	included PRO, EXPERT & COMBI 230		x1	x1	x1	x20	x1	x50	x1	x1	x1	x1	x1	x1	x1	x1	x1	x1	x1	x1	x1	x1	x1	x1	x1	x1	x1	x1	x1	x1	x1		
STANDARD 053915			x1	x1	x1	x20	x1	x50	x1	x1	x1	x1	x1	x1	x1	x1	x1	x1	x1	x1	x1	x1	x1	x1	x1	x1	x1	x1	x1	x1	x1		
2600 052277	ideal GYSPOT 2600				x20		x1	x50	x1																								
2700 053922	ideal GYSPOT 2700				x20		x1	x50	x1	x1																							

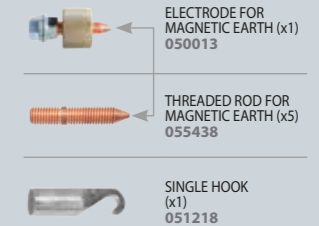

Mandrins pour pistolets - Mandrels for gun - Pistole & Anschlußstücke, Zubehör

Pour débosseurs - for dent pullers - Anschlußstück für Ausbeulspotter-Pistole

Pour soudeuses par point - for spot welding machines - Anschlußstück für Monopunktpistole

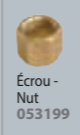
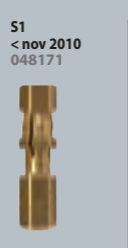

Masse pistolet acier - Steel gun earth adapter - Masse für Stahl Pistole



ALU



ALU BOX LIGHT Ø4 / STANDARD Ø4 / Ø5 & 6

mandrel for ALU GUN	alu magnesium screws 12 mm	alu silicium screws 12 mm	screwable rings	fast pulling rings	lifting rod
ø 4 x2 049000	ø 5 x1 048157	ø 6 x1 048164	ø 4 - M4 x200 050273	ø 4 - M4 x1000 050129	ø 5 x100 048140
ø 6 x100 048133	ø 4 - M4 x200 050280	ø 4 - M4 x1000 050136	ø 5 x100 048126	ø 6 x100 048003	ø 4 x5 050297
ø 5 x5 058712	ø 5 x5 058712	ø 3 : 180, 300, 500 mm 050792			

ALU BOX

LIGHT Ø 4 051522			ø 4 x200		ø 4 x200							
STANDARD Ø 4 050020	included GYSPOT ALU & COMBI 230		ø 4 x200		ø 4 x200		x5				x1	
Ø 5 & 6 048195	x1	x1	ø 5 x100 + ø 6 x100		ø 5 x100 + ø 6 x100		x5					



GYSPOT ARC PULL

DRAWN ARC

DENT PULLING

ALU + ACIER / STEEL / STAHL

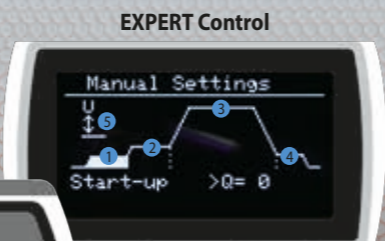
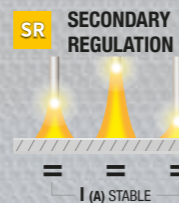

- Anneaux - Rings - Zugösen
- Goujons - Studs - Gewinbolzen
- Tiges inox - Stainless steel nails - Edelstahlnägel

- Amorce - Start-up - Zündung
- Décapage - Scouring (l & t) - Abbeizen
- Arc (l & t) - Arc - Lichtbogen
- Accroche - Hitching (l & t) - Verklebung
- Hauteur - Height - Höhe

7 languages
FR, EN, DE, SR, IT, NL & RU

SYNERGIC DIGITAL GUN



UNIQUE Linear Motor

DRAWN ARC PROCESS
Gas protection

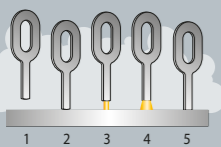

3 m, Ø 25 mm²
included
ARC PULL
200 & 350



Full control

Consumables for Gun



13

GYSPOT ARC PULL

DRAWN ARC DENT PULLING

PFC POWER FACTOR CORRECTION

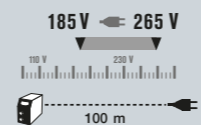

FV FLEXIBLE VOLTAGE

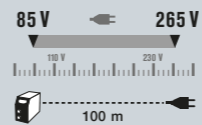

SPECIAL TEARING RIVETS

Spécial arrachage de rivets - Spezial-Zugnieten



∅ max
Alu: 6 mm
Fe: 5 mm

∅ max
Alu/Fe: 8 mm

GUN WITH CONNECTOR

GYSPOT ARC PULL 200

100 · 230V · 1~

200 A x1 MANUAL

FV SR AD

057470

included



GYSPOT ARC PULL 350

208 · 240V · 1~

350 A x1 MANUAL

PFC SR AD

062191

included



PACKS

ARC PULL 350 RIVET 064645

ARC PULL 350 PULLER 064652

ARC PULL 350 PULLER + RIVET 064669

	Arc Pull 350	Croco T400.70 043787	Rivet box 064584	Alu ring box 1.5 mm 059429	059610	Lifting rods 050792
ARC PULL 350 RIVET 064645	■	■	■	—	—	—
ARC PULL 350 PULLER 064652	■	—	—	■	x1	180, 300, 500 mm
ARC PULL 350 PULLER + RIVET 064669	■	■	■	■	x1	180, 300, 500 mm

MADE IN FRANCE 60974-1	50/60 Hz	I ₂ A	SYNERGIC	TECHNOLOGY		U ₂		kW	cm	ArcPull	ArcPull + gun	
				Acier/Steel	Alu	V	A					
GYSPOT ARC PULL 200	110 · 230V	10 · 100 (110V) 10 · 200 (230V)	■	Manual + Digital Gun Motion Control	—	20.4 · 24V (110V) 20.4 · 28V (230V)	16	2.4 (110V) 5.6 (230V)	OK	OK	20.5 x 25 x 33 8.6 kg	11.9 kg
GYSPOT ARC PULL 350	208 · 240V	10 · 350	■	Manual + Digital Gun Motion Control	■	20.4 · 34V	16	1.9	OK	OK	30 x 24.5 x 22 11 kg	14.3 kg



GYSPOT ARC PULL

DRAWN ARC DENT PULLING

ALU + ACIER / STEEL / STAHL



NEW
05/2021



∅ max
Alu: 8 mm
Fe: 12 mm

GYSPOT ARC PULL 700

380 · 480V · 3~

680 A

×1 MANUAL

SR IP 23

068315

included

- Manual synergic gun
3 m, 50 mm²
- Double earth clamps
- Arc Pull Rivet Box 700
- ALU RING BOX 1.5 mm
(AlSpec + AlMg3 + AlMgSi)
059429
- Lifting rod 180 mm
(x1)
- Gas protection
(x1)
068346
- Threaded studs holder
Ø 6 (x1)
068391
Ø 8 (x1)
068407

SYNERGIC DIGITAL GUN

★ ★ ★ ★ ★
**UNIQUE
Linear
Motor**

**DRAWN ARC
PROCESS**

**Ideal
all position**



3 m, 50 mm²
included ARC PULL 700

Full control

GYSPOT ARC PULL 200 & 350 - ACCESSORIES & CONSUMABLES

ACIER / STEEL / STAHL

STEEL STUDS BOX 350 059443	×1	×1	×1	×100	×100	×1	×100	×100	×1	×100	×100	×100	×1	×100	×200	×200	×1	×200	×1	×100

ALU

ALU STUDS BOX 350 059436	×1	×1	×1	×100	×1	×100	×1	×100	×1	×100	×200	×1	×100

ALU RING BOX 1 mm 059412	1mm ×50	1.5mm ×50	1mm ×50	1.5mm ×50	1mm ×50	1.5mm ×50	1mm ×20	1mm ×20	1mm ×20	×1	×1
ALU RING BOX 1.5 mm 059429	1.5mm ×50	1.5mm ×50	1.5mm ×50	1.5mm ×50	1.5mm ×50	1.5mm ×50	1.5mm ×20	1.5mm ×20	1.5mm ×20		
ALU RING BOX 2 mm 065703	2mm ×100										

STUDS HOLDER BOX 350 064591	×1	×1	×1	×1	×1	×1	×1

ARC PULL RIVET BOX 350 064584	×100	×1	×1	×1	×2	

GYSPOT ARC PULL 700 - ACCESSORIES & CONSUMABLES

ARC PULL RIVET BOX 700 068452	×100	×1	×1	×1	×1	×2

	MADE IN FRANCE		60974-1		50/60 Hz	I ₂	A	SYNERGIC		Acier/Steel	Alu	U ₂	V		A	kW		OK		OK		cm	ArcPull	ArcPull + gun
					3x 400 V																			
GYSPOT ARC PULL 700				3x 480 V						Manual + Digital Gun Motion Control				16 A (D)										





FAST DENT PULLING



ACIER / STEEL / STAHL

EASY TOOL CONNECTION

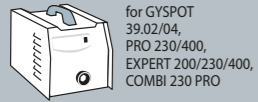

for GYSPOT
39.02/04,
PRO 230/400,
EXPERT 200/230/400,
COMBI 230 PRO

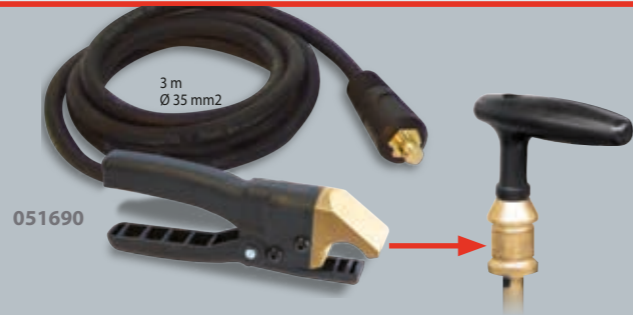

051690

3 m
Ø 35 mm²

 051584 380 g	 Anneaux - Rings - Anschweißösen 051652	 Fils ondulés - Wavy wires - Wellendraht 051669	 Rétreinte - Tempering - Glättwerkzeug 051676	 EASYGUN 051317	 Box of 3 electrodes for accessories 050822	 Poignée de tirage manuel 057289
---------------------	-----------------------------------------------------	-------------------------------------------------------------	-----------------------------------------------------------	-----------------------	---------------------------------------------------------	----------------------------------------------

MANUSPOT 050679



Tools set & support
for SPOT 600, 800, 1000, 1600,
Workstation & Dentstation



EASYGUN
051317



MANULINER
050471

3 m
Ø 35 mm²

PATENTS REGISTERED NUMBERS
001652108-0003
EUROPEAN TRADEMARK & DESIGN

MANULINER/GUN 056831

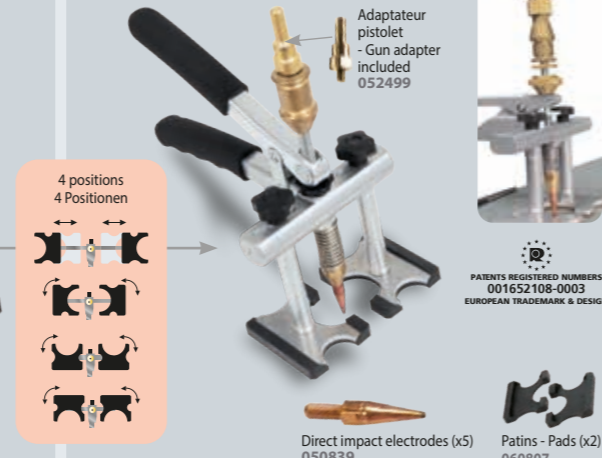

4 positions
4 Positionen

Adaptateur
pistolet
- Gun adapter
included
052499

Direct impact electrodes (x5)
050839 Patins - Pads (x2)
060807

PATENTS REGISTERED NUMBERS
001652108-0003
EUROPEAN TRADEMARK & DESIGN

FAST & EASY



RINGMATIC 052154

included
(x 50)



Option
Adaptateur
pistolet - Gun
adapter
052499

LAMPE LIGNE DROITE - Straight line lamp - Dentline-laser

056770



QUICK SPOT AIR GUN V2

057340

LIGHT
920 g



2,5 m

AIR

QUICK SPOT AIR GUN V2 + Mini-fraiseuse - Mini- Druckluftfräser

065567

057340 + 063228



Included
Tungsten drill Ø 6 mm
054172

Adaptateur pistolet - Gun adapter
052826

ALU

ARC PULLER PREMIUM

ULTRA RESISTANT
No deformation

Full rotation
GRIP

Multi positions

065161

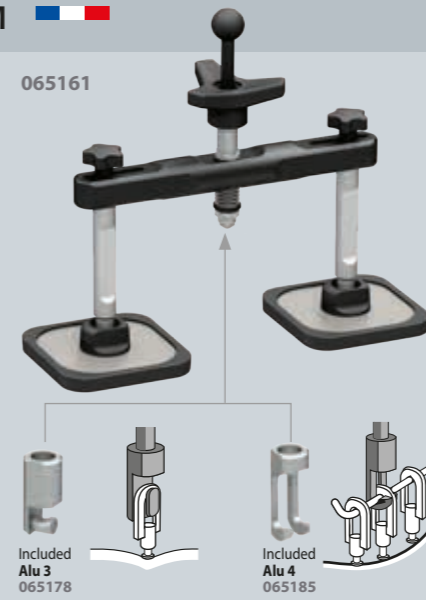

Included
Alu 3
065178

Included
Alu 4
065185

ALU PULLER

051003

4 positions
4 Positionen

Mini Puller
050921

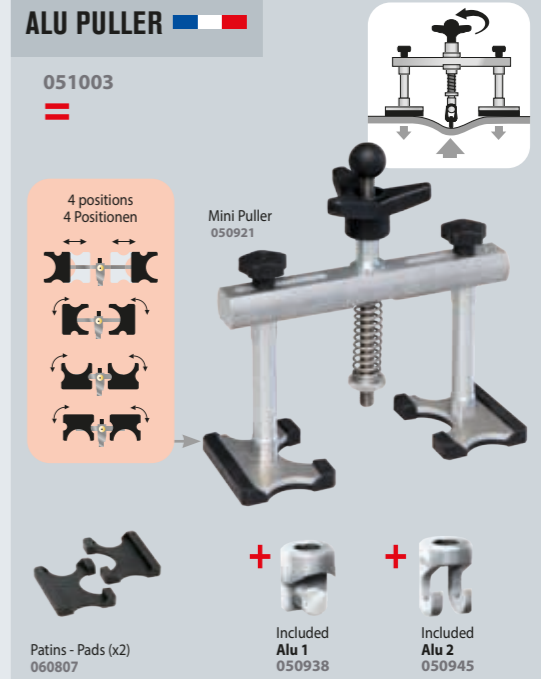

Patins - Pads (x2)
060807

Included
Alu 1
050938

Included
Alu 2
050945

ANNEAUX DE TIRAGE RAPIDE - Fast pulling rings

058743

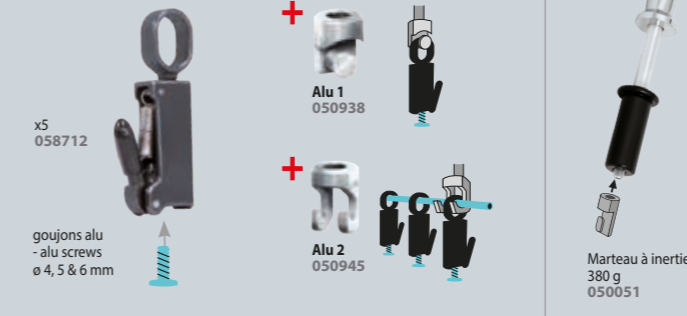

x5
058712

Alu 1
050938

Alu 2
050945

Marteau à inertie
380 g
050051

MARTEAUX ALU - Alu hammers

020986



ALU

ASPIRATEUR PNEUMATIQUE POUR POUSSIÈRES ALUMINIUM (ATEX) - Pneumatic alu dust atex vacuum cleaner

058866

Capacity : 25 l
Working air pressure : 6 bar
Air consumption at 6 bar : 800 l/min
Suction connection : 50 mm
Max suction capacity : 150 m³/h
Max vacuum level : 2000 mm H₂O
Recommended compressor power : 7.5 HP
↳ 74 x 45 x 45 mm
▲ 18 kg

included
Filtre -
Filter
058873

included
Sac - Bag
5 kg
058880

5 m
Output Ø 29 mm
Input Ø 35 mm



Décapeur thermique - Heat gun - Heißluftpistole

066311



Affichage digital
Digital display

Pistolet à air chaud autonome à gaz - Gas hot air gun

060777



Lampe à souder - Blow torch - Lötlampe

052741



Novacet + (Butane/propane/ propylene) 380 ml/220 g

040441



Brosses - Brushes - Bürsten - Brossen - Cepillos

044258



Crayon marqueur thermique - Thermal marking pencil

052765



Thermomètre infrarouge - Infrared Thermometer

052994



Spray refroidisseur - Freezer spray

048898

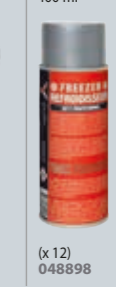

(x 12)

Spray barrière thermique - Heat barrier spray

054325



MARTEAUX INERTIE - Slide hammers - Ausbeulhammer

COMPLETE 057272



1,1 kg 049802

- included (x1) 049482
- included (x20) 052239

- Options
- (x1) 054028
 - (x5) 050839

Clous - Nails - Nägel



1,1 kg 041813

- Ø 2, M4 (x1) 049277
- Ø 2 (x100) 041561
- MIG/MAG nozzle for Nail welding 041523

Rondelles - Washers - Ringe



1,7 kg 051201

- Ø 16, 8x16 (x1) 049574
- (x1) 051218
- 8x16 (x100) 049444

COMPLETE KIT 051225

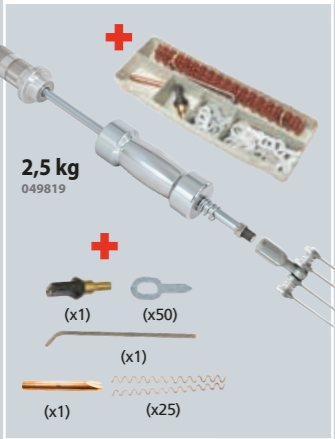

2,5 kg 049819

- (x1) (x50)
- (x1)
- (x1) (x25)

Kit marteau à inertie - Inertia hammer kit - Ausbeulhammereset



6 kg 051928

STANDARD

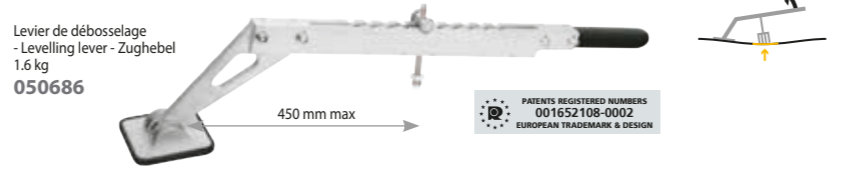

Levier de débousselage - Levelling lever - Zughebel 1.6 kg 050686

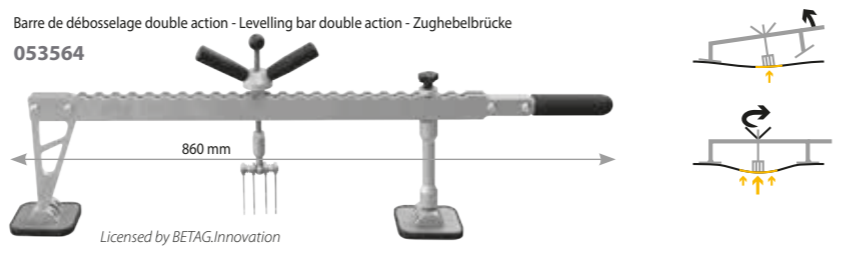

Barre de débousselage double action - Levelling bar double action - Zughebelbrücke 053564

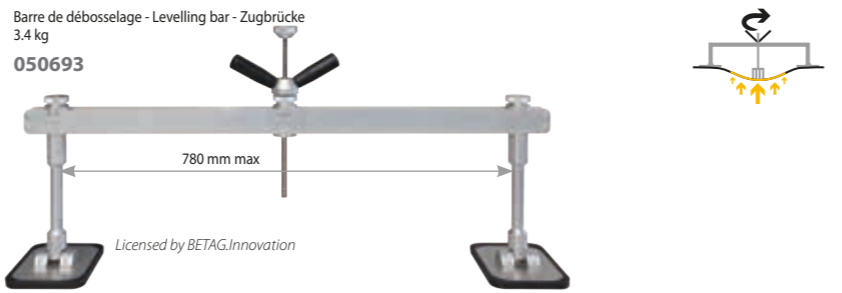

Barre de débousselage - Levelling bar - Zugbrücke 3.4 kg 050693

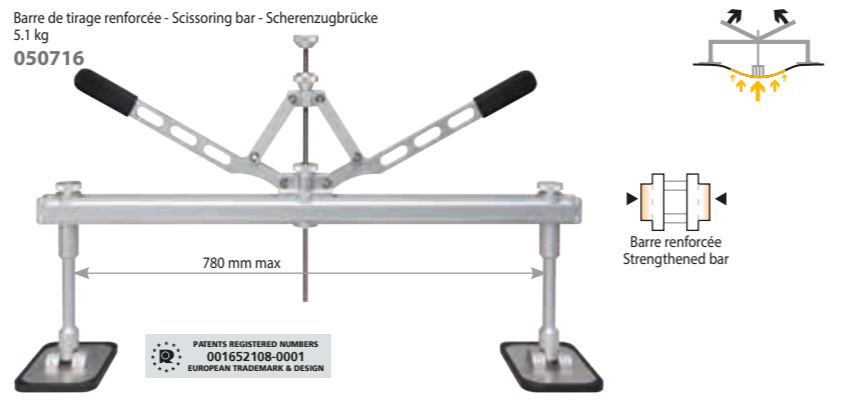

Barre de tirage renforcée - Scissoring bar - Scherenzugbrücke 5.1 kg 050716

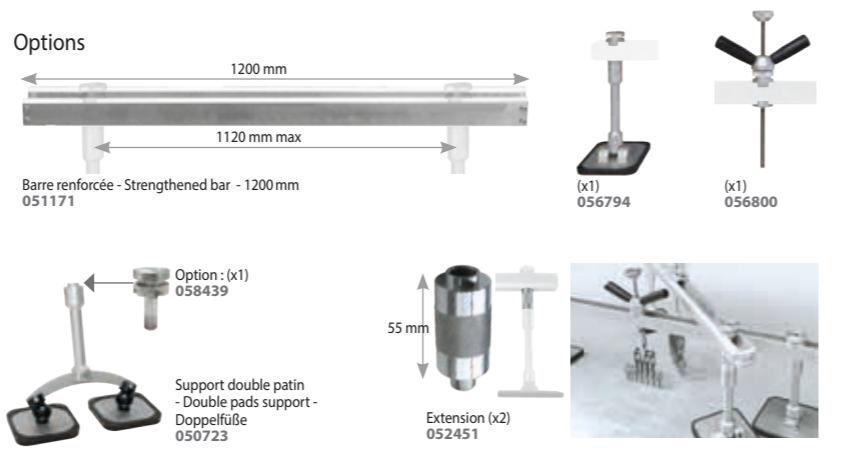

Options

- Barre renforcée - Strengthened bar - 1200 mm 051171
- (x1) 056794
- (x1) 056800
- Option: (x1) 058439
- Support double patin - Double pads support - DoppelfüÙe 050723
- Extension (x2) 052451

PREMIUM

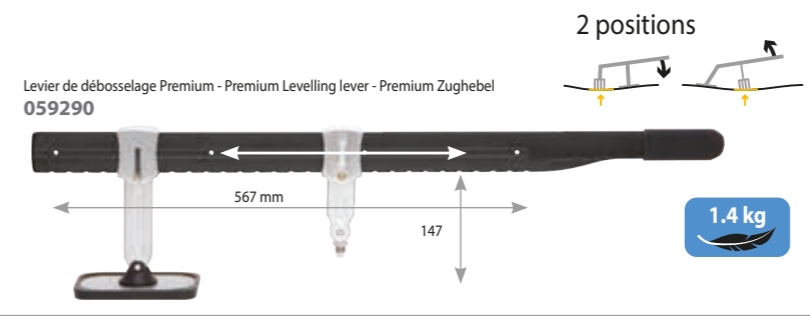

Levier de débousselage Premium - Premium Levelling lever - Premium Zughebel 059290

2 positions

1.4 kg

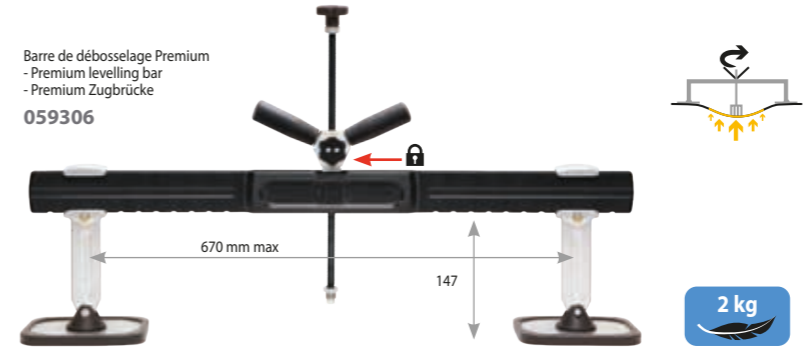

Barre de débousselage Premium - Premium levelling bar - Premium Zugbrücke 059306

2 kg

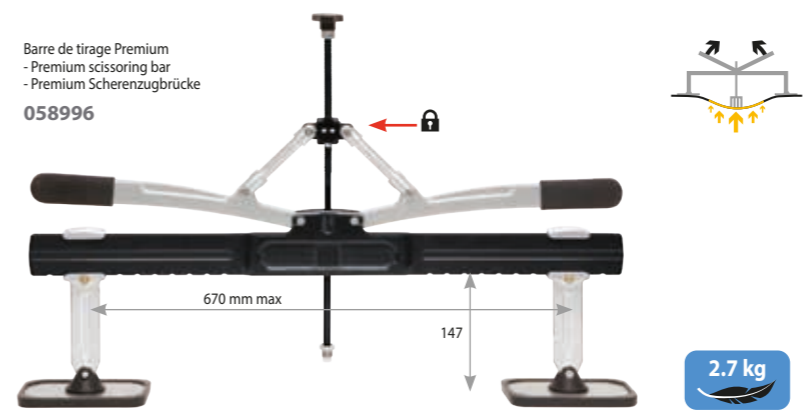

Barre de tirage Premium - Premium scissoring bar - Premium Scherenzugbrücke 058996

2.7 kg

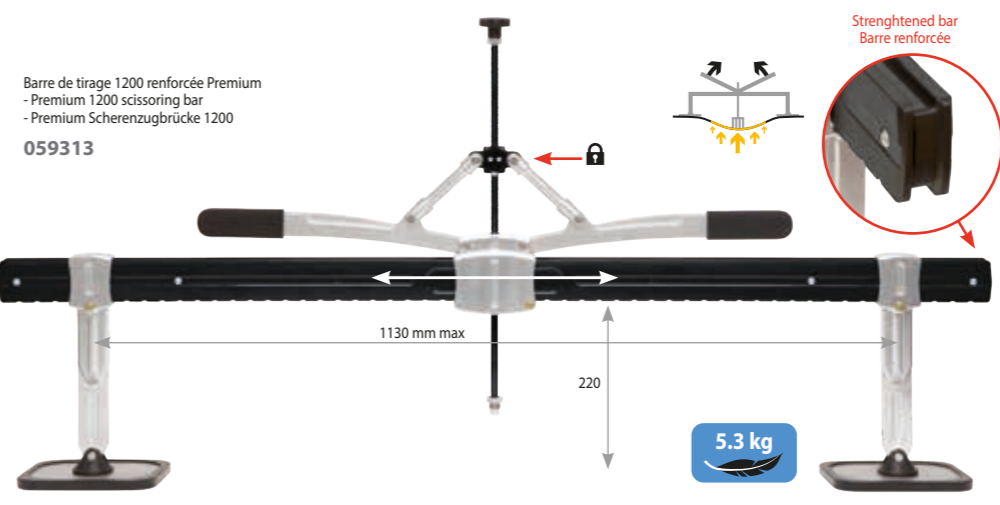

Barre de tirage 1200 renforcée Premium - Premium 1200 scissoring bar - Premium Scherenzugbrücke 1200 059313

5.3 kg

ULTRA LIGHT

ULTRA ERGONOMIC

ULTRA RESISTANT No deformation

PERFECT BALANCE

Slide & Lock

Full rotation

Multi positions

Options



059320

x1 059337 x2 061293

059399

x1 059344 x2 059351

x1 059368 x2 059375

Arc Puller Premium 065161



- Included: Alu 3 065178
- Alu 4 065185

Griffes - Gripping hook head - Ausbeulhaken

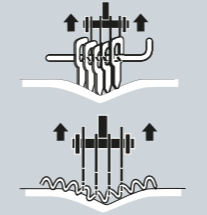

Poignée de tirage 3 dents - Pulling handle 3 claws - Handzugkralle 3-fach 057326



Poignée de tirage 2 dents - Pulling handle 2 claws - Handzugkralle 2-fach 057302



Alu Puller 051003



Lifting rods 180, 300 & 500 mm 050792

Curved lifting rod 280 mm 064706

Compatibility: BASIC PREMIUM



Long pads needed



SPECIAL CHAIN



NEW Ø M10/M14



CHARIOTS - Trolleys

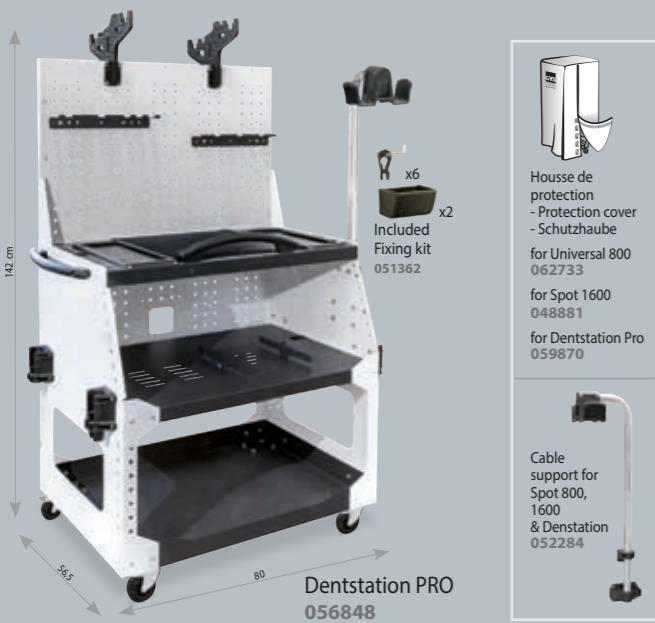
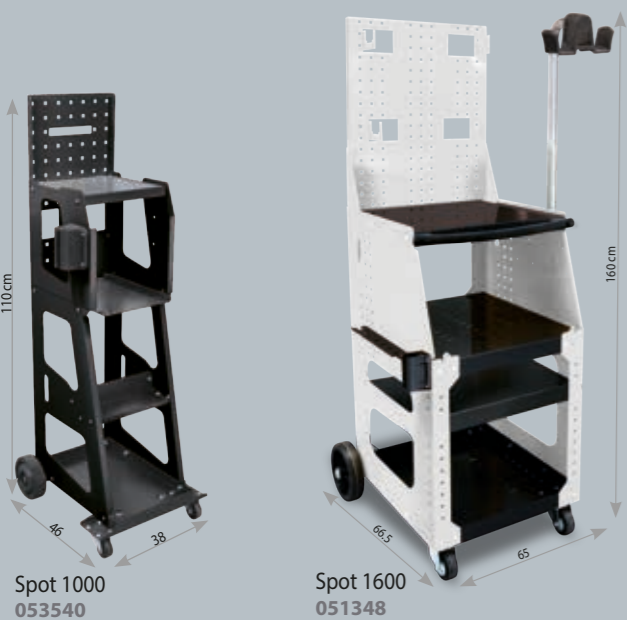

Compatibility

GYSPT	Spot 600	Spot 1000	Spot 800	Universal 800	Spot 1600	Dentstation Pro
2600, 2700	✓	✓	✓		✓	✓
34.02/04	✓	✓	✓		✓	✓
3902/04	✓	✓	✓		✓	✓
PRO 230/400	✓	✓	✓		✓	✓
EXPERT 200/230/400	✓	✓	✓		✓	✓
ALU PRO FV	✓		✓		✓	✓
COMBI 230 E PRO				✓	✓	✓
ARCPULL 200/350				✓	✓	✓



DENT PULLING WORKSTATIONS

**UNE SOLUTION COMPLÈTE
A COMPLETE SOLUTION
KOMPLETTLÖSUNGEN**

EASYLINER

			ALL IN 1 BOX
GYSPT (guns & consumables included)	SPOT 1000 053540	Levelling bar double action 053564 + Dent box easy 053632	
39.02 053618	GYSPT 39.02	✓	

PROLINER

GYSPT (guns & consumables included)	UNIVERSAL 800 051331	Cable support 052284	Levelling bar double action 053564 + Dent box bar 050037
39.02 035775	GYSPT 39.02		✓
39.04 035782	GYSPT 39.04		✓
PRO 230 035799	GYSPT PRO 230		✓
PRO 400 035805	GYSPT PRO 400		✓
GYSPT (guns & consumables included)	UNIVERSAL 800 051331	Cable support 052284	Alu puller 051003
ALU PRO FV 035836	GYSPT ALU PRO FV	✓	✓
GYSPT (guns & consumables included)	Weld 810 037489	Cable support 052284	Arc puller premium 065161
ARC PULL 200 065260	GYSPT ARC PULL 200	✓	✓



SPEEDLINER

GYSPT (guns & consumables included)	SPOT 1600 051348	Cable support 052284	Fixing kit 051362	Levelling bar 050693	Multihook heads 049758	Alu Box 05 & 6 048195	Alu puller 051003	Alu hammers 020986	Set of pencil punches with 6 teflon tips 052888	Mini disc sander 051829	051423	Infrared Thermometer 052994	Thermal marking pencil 052765	
ALU PRO FV 036055	GYSPT ALU PRO FV						✓							
GYSPT (guns & consumables included)	SPOT 1600 051348	Cable support 052284	Manuspot 050679	Levelling bar 050693	Levelling lever 050686	052451	Multihook heads 049758+049734	3 lifting rods 050792	Dent box consumables 051515	Magnetic earth 049666	Ringmatic 052154	Alu puller 051003	Arc puller premium 065161	4 m³ support 059665
39.02 035010	GYSPT 39.02				✓									
39.04 035027	GYSPT 39.04													
PRO 230 036017	GYSPT PRO 230													
PRO 400 036024	GYSPT PRO 400													
EXPERT 200 028180	GYSPT EXPERT 200													
EXPERT 230 066984	GYSPT EXPERT 230				✓									
EXPERT 400 028197	GYSPT EXPERT 400													
COMBI 230 E.PRO 036062	GYSPT COMBI 230 E.PRO	✓	×2				✓							
ARC PULL 200 065284	GYSPT ARC PULL 200													
+ EXPERT 200 066991	GYSPT ARC PULL 200 + EXPERT 200													
+ EXPERT 230 066991	GYSPT ARC PULL 200 + EXPERT 230	✓	×2				✓						✓	✓
+ EXPERT 400 065291	GYSPT ARC PULL 200 + EXPERT 400													
without generator 035058														✓

SPEEDLINER PREMIUM

GYSPT (guns & consumables included)	SPOT 1600 051348	Cable support 052284	Fixing kit 051362	Premium levelling bar 059306	Hook head 059382	3 lifting rods 050792	Alu Ring Box 1 mm 059412	Arc puller premium 065161	Alu hammers 020986	Set of pencil punches with 6 teflon tips 052888	Infrared Thermometer 052994	4 m³ support 059665			
ARC PULL 200 065277	GYSPT ARC PULL 200						✓								
GYSPT (guns & consumables included)	SPOT 1600 051348	Cable support 052284	Manuspot 050679	Ringmatic 052154	Manual pulling handle 057289	Premium levelling bar 059306 + Premium levelling lever 059290	Premium levelling lever 059290	220 mm pads 061293	Hook head 049758 + 059658 + 059382	3 lifting rods 050792	Dent box consumables 051515	Magnetic earth 049666	Fast pulling rings (x5) 058712 + Alu puller 051003	Arc puller premium 065161	4 m³ support 059665
PRO 230 028265	GYSPT PRO 230														
PRO 400 028272	GYSPT PRO 400														
EXPERT 200 028289	GYSPT EXPERT 200														
EXPERT 230 067004	GYSPT EXPERT 230					✓									
EXPERT 400 028302	GYSPT EXPERT 400														
COMBI 230 E.PRO 028319	GYSPT COMBI 230 E.PRO	✓	×2					✓							
ARC PULL 200 065307	GYSPT ARC PULL 200														
+ EXPERT 200 067011	GYSPT ARC PULL 200 + EXPERT 200														
+ EXPERT 230 067011	GYSPT ARC PULL 200 + EXPERT 230	✓	×2					✓					✓	✓	
+ EXPERT 400 065314	GYSPT ARC PULL 200 + EXPERT 400														



✓ ALU PRO FV

SPEEDLINER ALU

✓ 39.02, 39.04
✓ PRO 230, PRO 400
✓ EXPERT 200, EXPERT 230, EXPERT 400

ACIER / STEEL / STAHL



✓ COMBI 230 E.PRO
✓ ARC PULL 200 + EXPERT 200
✓ ARC PULL 200 + EXPERT 230
✓ ARC PULL 200 + EXPERT 400

SPEEDLINER PREMIUM ALU + ACIER / STEEL / STAHL



COMPLETE SYSTEM

★ ★ ★

✓ COMBI 230 E.PRO
✓ ARC PULL 200 + EXPERT 200
✓ ARC PULL 200 + EXPERT 230
✓ ARC PULL 200 + EXPERT 400

SPEEDLINER ALU + ACIER / STEEL / STAHL



✓ ARC PULL 200

SPEEDLINER PREMIUM ALU

✓ PRO 230, PRO 400
✓ EXPERT 200, EXPERT 230, EXPERT 400

ACIER / STEEL / STAHL



DENTSTATION

--	--	--	--	--	--	--	--	--	--	--	--	--	--	--	--

39.02 028012	GYSPT 39.02					✓									
39.04 028029	GYSPT 39.04														
PRO 230 036420	GYSPT PRO 230														
PRO 400 036437	GYSPT PRO 400														
EXPERT 200 036734	GYSPT EXPERT 200					✓									
EXPERT 230 067028	GYSPT EXPERT 230														
EXPERT 400 036741	GYSPT EXPERT 400														
COMBI 230 E.PRO 036444	GYSPT COMBI 230 E.PRO	✓	x2				✓								
ARC PULL 200 + EXPERT 200 065321	GYSPT ARC PULL 200 + EXPERT 200														
+ EXPERT 230 067035	GYSPT ARC PULL 200 + EXPERT 230	✓	x2				✓								✓
+ EXPERT 400 065338	GYSPT ARC PULL 200 + EXPERT 400														

DENTSTATION PREMIUM

--	--	--	--	--	--	--	--	--	--	--	--	--	--

PRO 230 028067	GYSPT PRO 230														
PRO 400 028074	GYSPT PRO 400														
EXPERT 200 036758	GYSPT EXPERT 200					✓									
EXPERT 230 067042	GYSPT EXPERT 230														
EXPERT 400 036765	GYSPT EXPERT 400														
COMBI 230 E.PRO 036772	GYSPT COMBI 230 E.PRO	✓	x2				✓								
ARC PULL 200 + EXPERT 200 065345	GYSPT ARC PULL 200 + EXPERT 200														
+ EXPERT 230 067059	GYSPT ARC PULL 200 + EXPERT 230	✓	x2				✓							✓	✓
+ EXPERT 400 065352	GYSPT ARC PULL 200 + EXPERT 400														

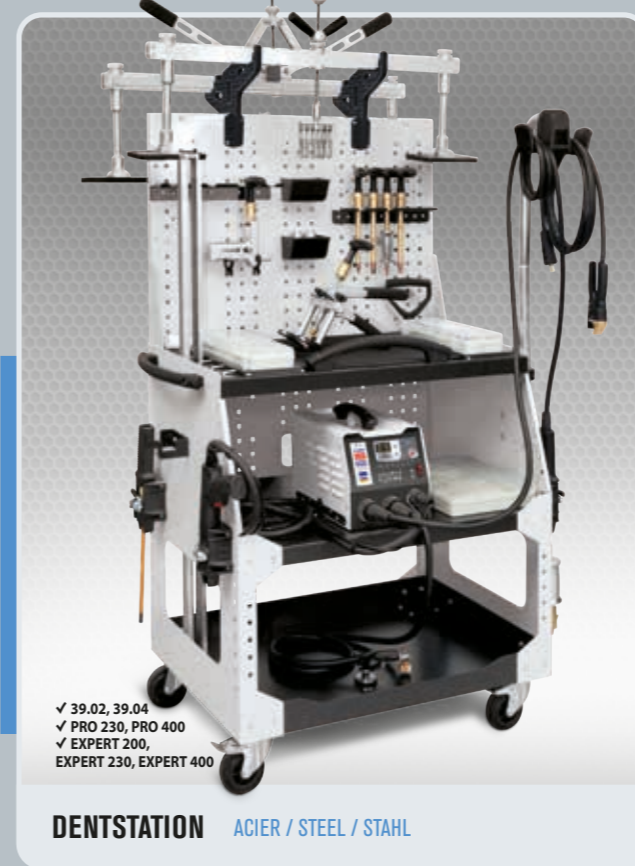

✓ 39.02, 39.04
✓ PRO 230, PRO 400
✓ EXPERT 200, EXPERT 230, EXPERT 400

DENTSTATION ACIER / STEEL / STAHL

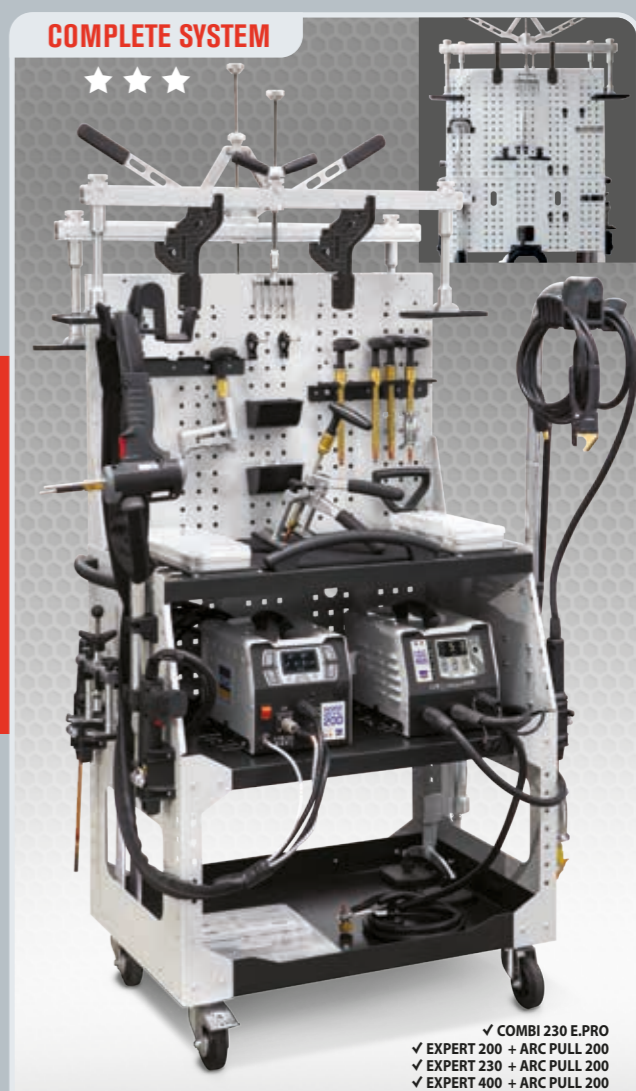

✓ COMBI 230 E.PRO
✓ EXPERT 200 + ARC PULL 200
✓ EXPERT 230 + ARC PULL 200
✓ EXPERT 400 + ARC PULL 200

DENTSTATION ALU + ACIER / STEEL / STAHL

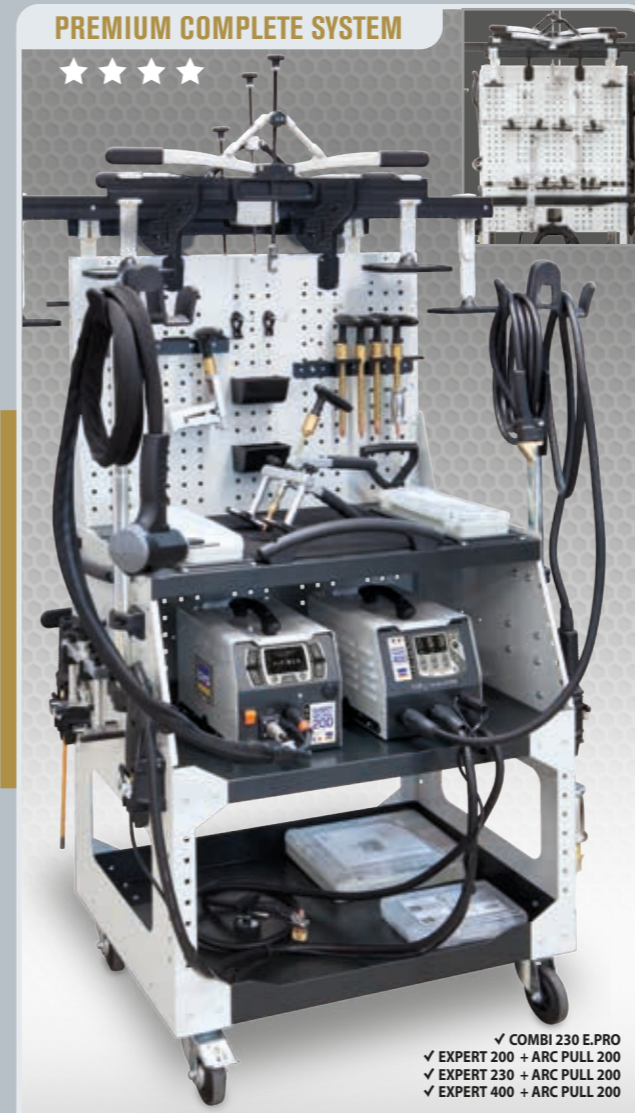

✓ COMBI 230 E.PRO
✓ EXPERT 200 + ARC PULL 200
✓ EXPERT 230 + ARC PULL 200
✓ EXPERT 400 + ARC PULL 200

DENTSTATION PREMIUM ALU + ACIER / STEEL / STAHL



✓ PRO 230, PRO 400
✓ EXPERT 200, EXPERT 230, EXPERT 400

DENTSTATION PREMIUM ACIER / STEEL / STAHL

PULLING SYSTEMS

ÉQUERRE DE TIRAGE

- Draw aligner - Schnellausbeul-Richtausleger

052475

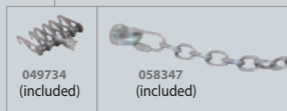
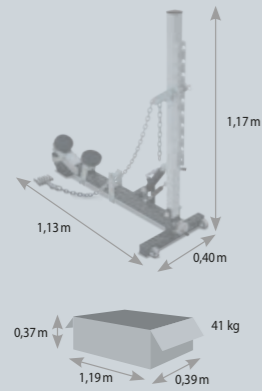
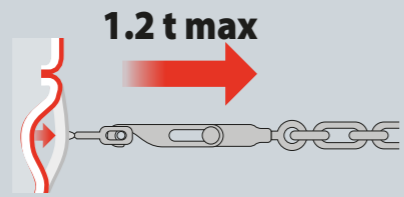

OPTIONS

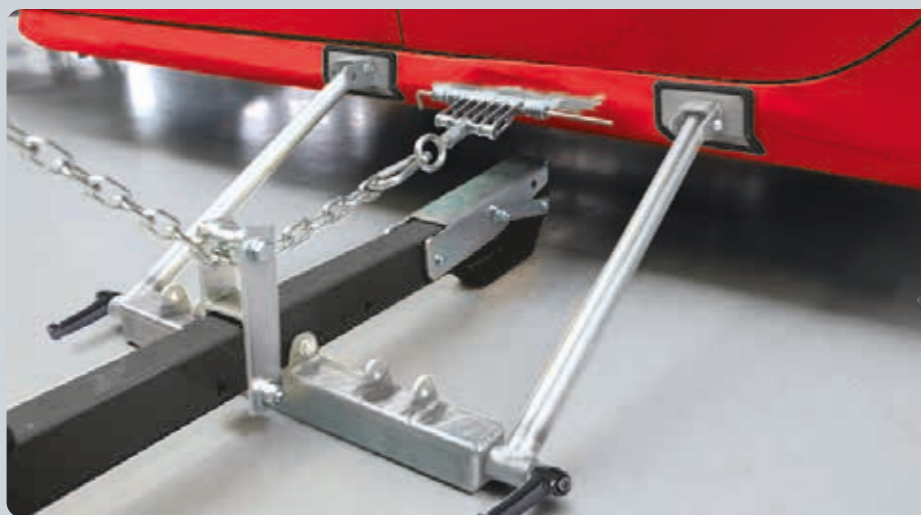
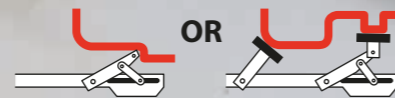
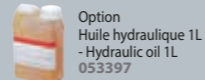

OPTIONS

Bras de bas de caisse - Rocker panel arms for draw aligner - Abstütztraverse für Richtausleger



7 kg

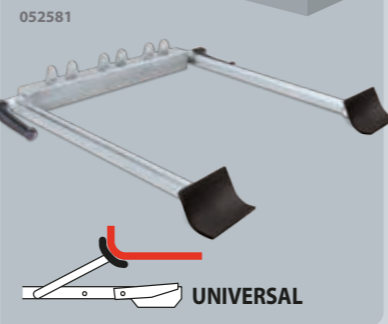

SYSTÈME DE TIRAGE SMART PULLER SILVER

- Smart puller silver pulling system - Schnellausbeul-Richtausleger Smart puller silver

054820

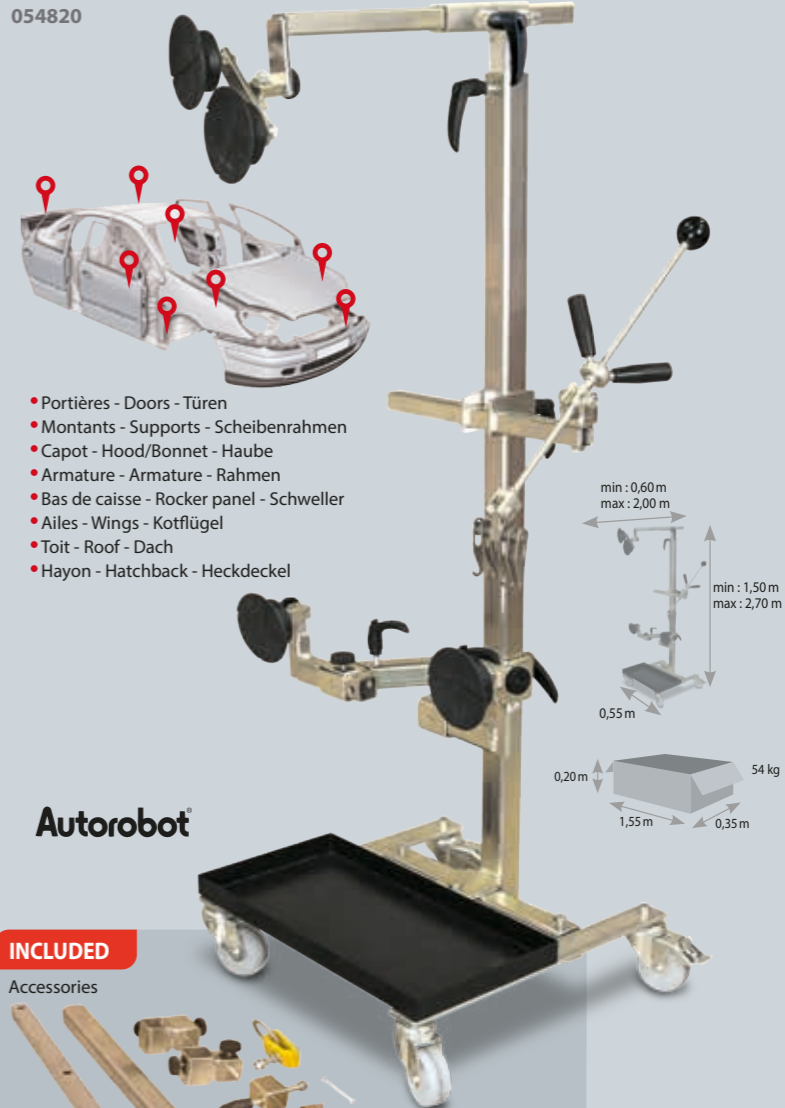
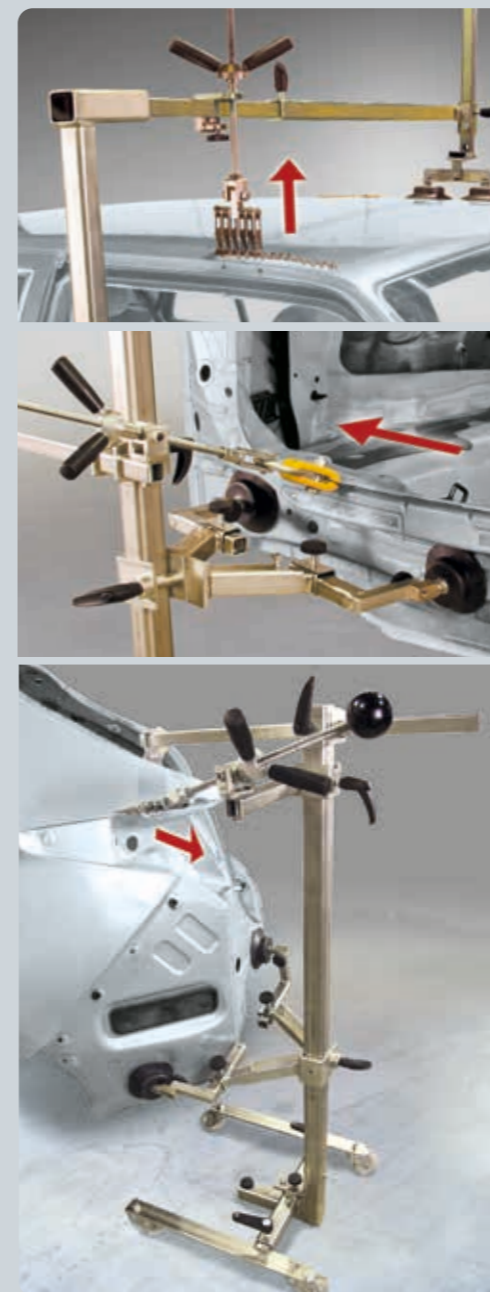

- Portières - Doors - Türen
- Montants - Supports - Scheibenrahmen
- Capot - Hood/Bonnet - Haube
- Armature - Armature - Rahmen
- Bas de caisse - Rocker panel - Schweller
- Ailes - Wings - Kotflügel
- Toit - Roof - Dach
- Hayon - Hatchback - Heckdeckel

Autorobot

INCLUDED

Accessories



ELECTRO POWER - Zug-Druckpresse

Spreading / Estensione

Pressing / Compressione

Pulling / Tiro

Pushing / Spinta

Applications / Applicazioni

with accessories: 057425

-PULLING POWER: 5 Ton.
-PUSHING POWER: 5 Ton.
-PISTON STROKE: 130 mm

MADE IN ITALY

Li-Ion battery (included) 058514

Standard kit : 425x620x210 mm
Standard kit Total weight: 18 kg
057401

Accessories kit : 425x620x150 mm
Accessories kit Total weight: 20 kg
057418

BASIC 4T
052345



BASIC 10T
052338



PRO 4T
057432



PRO 10T
057449



OPTIONS



Huile hydraulique 1L
- Hydraulic oil 1L
053397

BARRE D'ANCRAGE - Anchor bar - Türspanner

053045

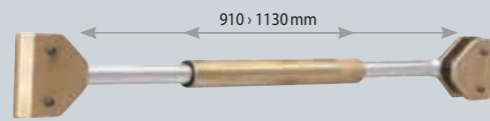

053052



MESURES - Measuring tools - Vermessung

BODYMETER, Mechanical measurements

052130

250 > 2230 mm



GYSMETER, Electronic measurements

052093

Measuring report



400 > 2650 mm

Light weight
measuring arm
with an easy to read
digital display

SATELLITE INTELLIGENT - Smart Satellite - Satellite Komplett-Kit

The best from **Autorobot**
www.autorobot.com/pdf/7148_ENG.pdf
MADE IN FINLAND

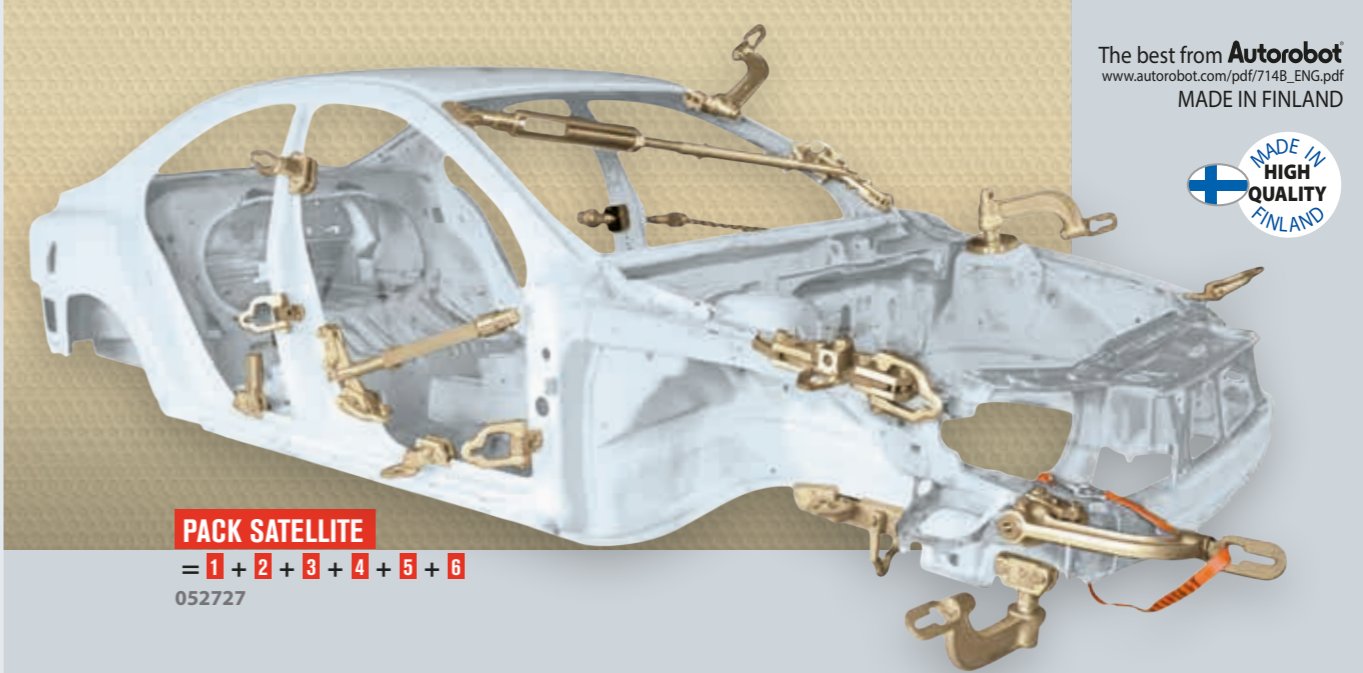

PACK SATELLITE

= 1 + 2 + 3 + 4 + 5 + 6

052727

1

SATELLITE
- Satellite - Satellite Basisbügel-Set

052710



2

KIT MAC PHERSON (A)
- Mac Pherson Kit - Befestigungskit-
Federbein (McPherson)

052703



3

BARRE POUR TIRER/POUSSER
- Push/Pull Bar
- Zug/Druck-Stangenset

052673

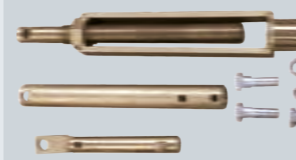

4

SATELLITE (B)
- Bügelverlängerung

052680

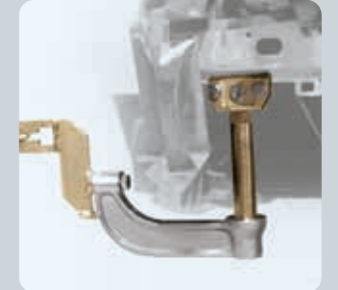
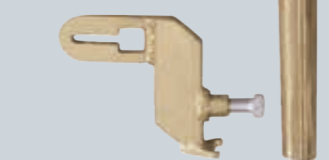

5

SANGLE DE SÉCURITÉ
- Safety Strap - Sicherungsgurt

044036



6

DOUBLE PINCE SATELLITE (C)
- Double Clamp Satellite
- Satellite Doppelklemme

052697



PINCE DE TIRAGE MULTI-USAGE

- Versatile pulling clamp
- Multifunktions-Zugklemme

053571

Autorobot



POWER-PULLER 4T

059740



HIGH QUALITY

CROCHET DE TIRAGE - Frame Straightening - Ziehwerkzeuge

Kit crochet de tirage « boomerang »
- Boomerang pulling hook set
- Zughaken Set «Boomerang»

052659

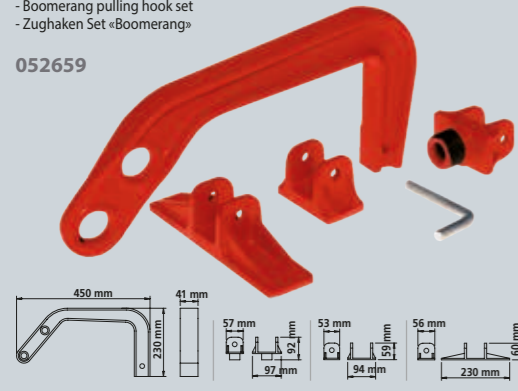

PINCES DE TIRAGE - Frame Straightening - Ziehwerkzeuge

Mini pince de tirage à blocage manuel
- Manual-locking pull clamp
- Mini Klemme von Auflage in Handblockieren
056855

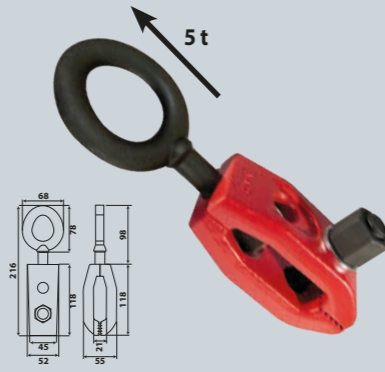

Pince de tirage à blocage automatique
- Self-locking pull clamp
- Selbstklemmende Zugklemme
052642



PINCE PIVOTANTE - Swivel clamp

060968



Pince de tirage à blocage automatique
- Self-locking pull clamp
- Selbstklemmende Zugklemme
060944

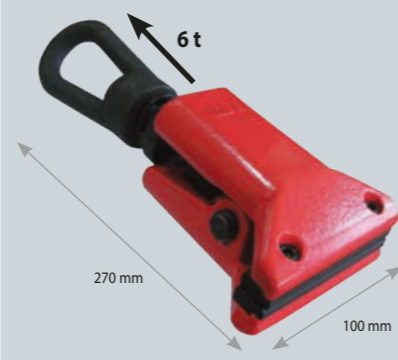

Pince de tirage à angle droit
- Right angle pull clamp
- Zugklemme 90° Winkel
052666

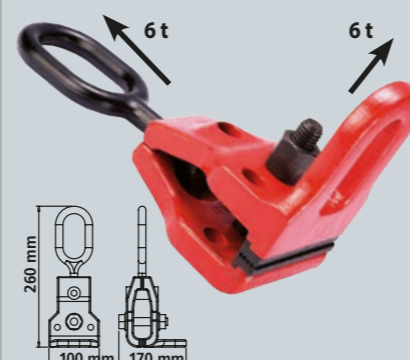

PINCES DE TIRAGE LARGES - Wide pull clamps

Pince de tirage large 2 directions
- 2-way wide serrate clamp
061217

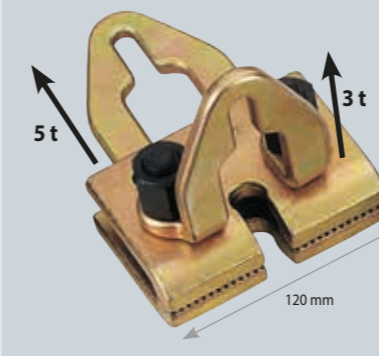

Pince de tirage large multidirections
- Multi-way wide serrate clamp
061224

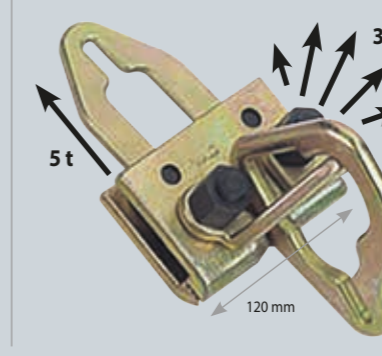

PINCE DE TIRAGE MULTIPLE - Multiple pull clamp

Pince multiple répartition de charge
- Load spread multi clamp
060999

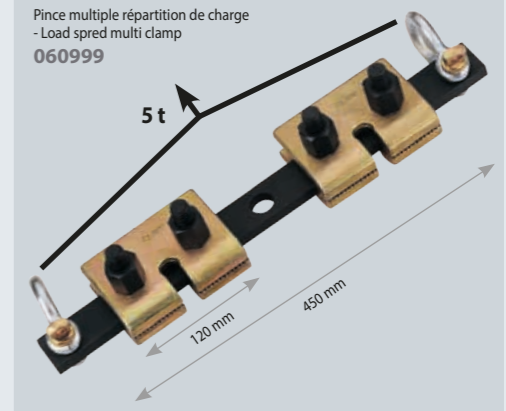

PINCES DE TIRAGE FAIBLE LARGEUR - Small pull clamps

Pince bec de canard
- Long nose clamp
060951

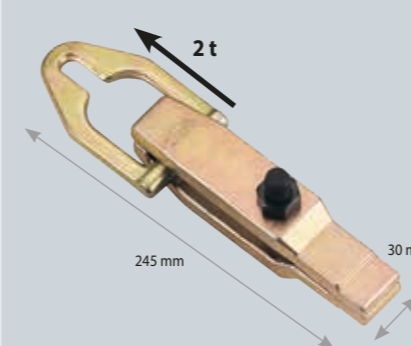

Pince de tirage faible largeur
- Small mouth pull clamp
061231

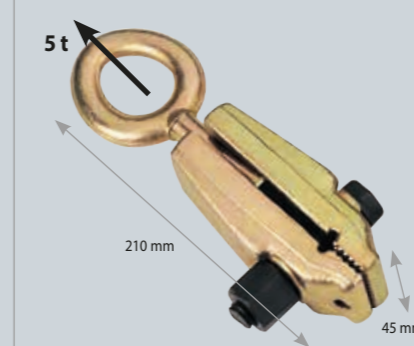

Pince contournement de rebord
- Box clamp
061170

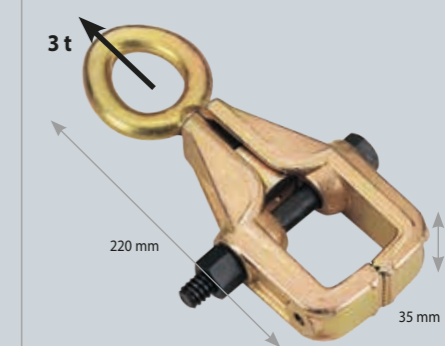

PASSAGE DE ROUE - Arch hooks

Crochet passage de roue petite dimension
- Small arch hook
060975

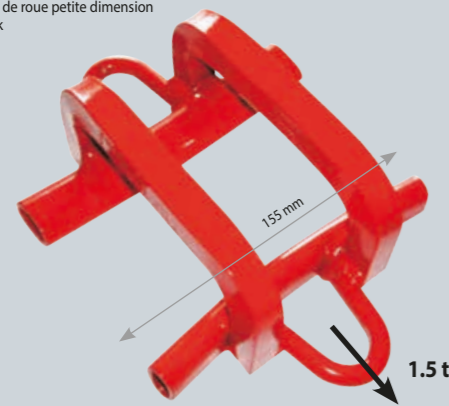

Crochet passage de roue grande dimension
- Large arch hook
060982

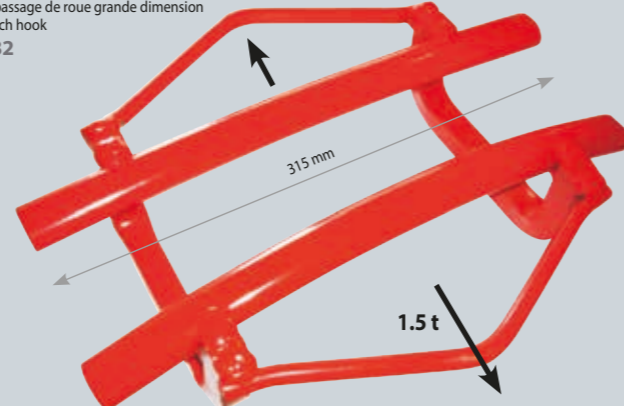

PINCE CISEAUX LARGEUR 45 MM - 45 mm scissors clamp

061187

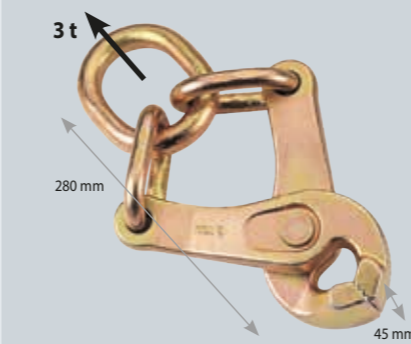

PINCE DE TIRAGE POUR ANGLE 90° - 90 Degree corner clamp

059757



PINCE DE TIRAGE TYPE C - C type clamp

061200



CHAÎNES DE TIRAGE - Frame Straightening - Ziehwerkzeuge

Chaîne de tirage 10 mm
Body chain 10 mm
061255

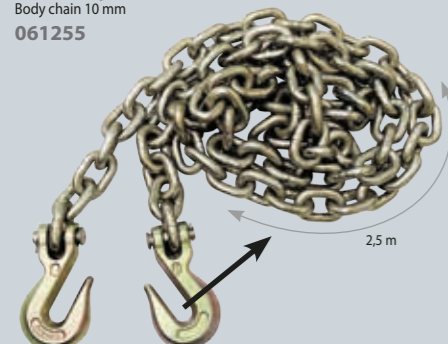

Charge de rupture - Breaking load - Zuglast : 12 t

Raccord de chaîne double crochet
- Chain joint double grab hook
061156

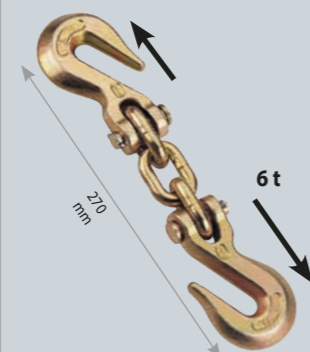

Raccord de chaîne pour deux pinces
- Chain joint for two clamps
061163

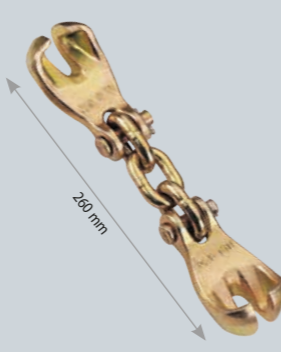

NEW
067745

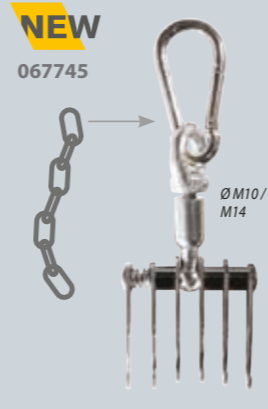

KIT MARTEAU À INERTIE - Inertia hammer kit - Ausziehhammer kit

Kit marteau à inertie
- Inertia hammer kit
- Ausziehhammer kit
051928

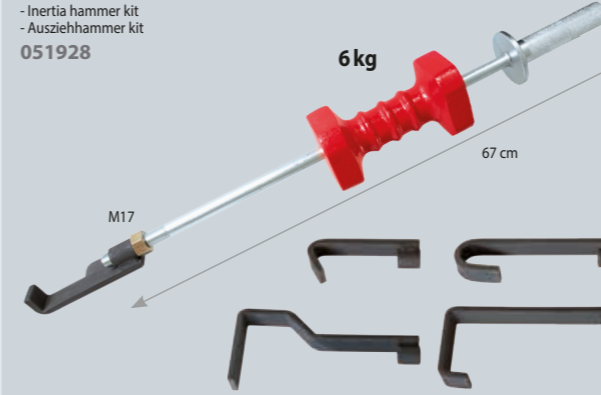

Marteau à inertie 6+3 kg avec griffe de chaîne
- Inertia hammer 6+3 kg with chain hook
- Ausziehhammer 6+3 kg
061194

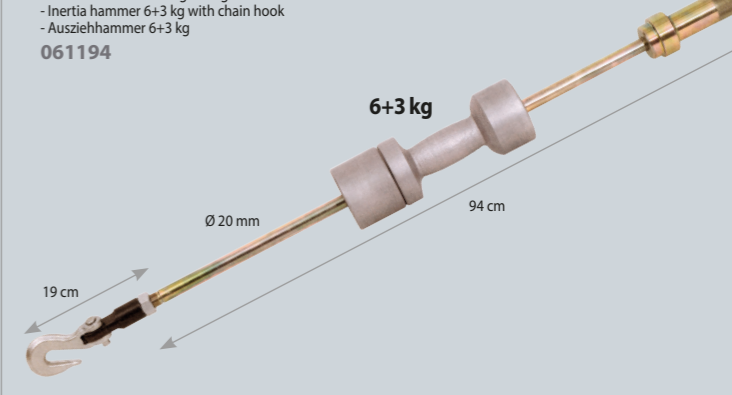



Débosselage rapide et sans peinture
- PDR: Paintless Dent Repair
- Lackschadenfreies Ausbeulen

PAINTLESS DENT REPAIR



Youtube



MADE IN FRANCE

50 Hz	230V, 1~	A	W	2400	35+120	Freq. kHz	INTEGRATED TECHNOLOGY	Liquid Cooling	Cable (m)	Inductor	cm	kg
50 Hz	230V, 1~	A	W	2400	35+120		PFC FV	—	2	2,5	22 x 36 x 27	7,5

OPTION
Spray refroidisseur - Freezer spray -50 °C
400 ml
(x 12) 048898

INDUCTEUR DÉBOSSÉLAGE - Dent Pulling Inductor - Dellenmatrix

GYSDUCTION AUTO DENT REPAIR 054981 = GYSDUCTION AUTO + Dent pulling inductor 054776



Licensed by BETAG.Innovation

INSPECTION CARROSSERIE - Dent Pulling Inductor - Ausbeul-Induktor

Planche flexible pour inspection de la carrosserie - Ausbeul-Matrix Ø 800 mm
059122

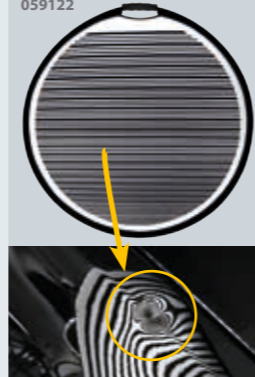

KIT MAGNÉTIQUE DE DÉBOSSÉLAGE SANS PEINTURE - Paintless Dent Repair magnetic kit - Magnetisches Ausbeul-Kit

053168

EXELTOOLS

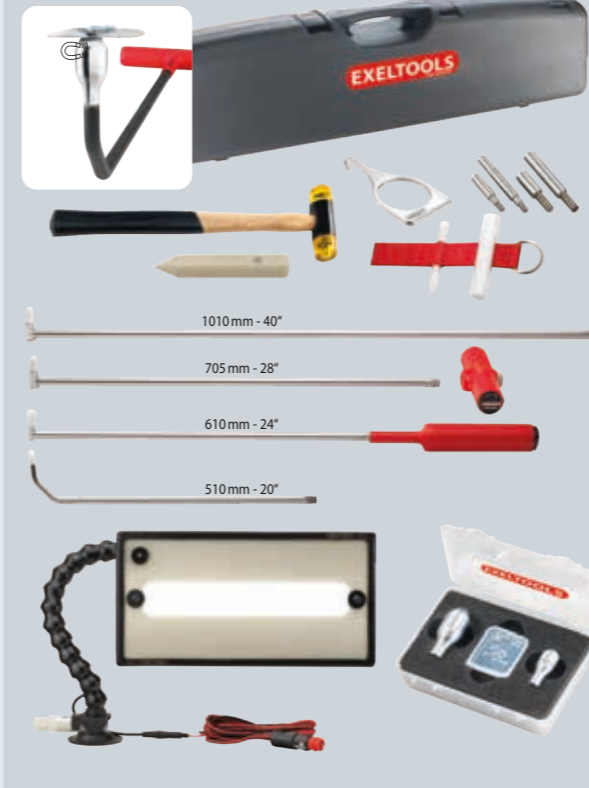

LAMPES DE DÉBOSSÉLAGE - Paintless Dent Repair lamps - Ausbeullampe



056749
Made in Taiwan

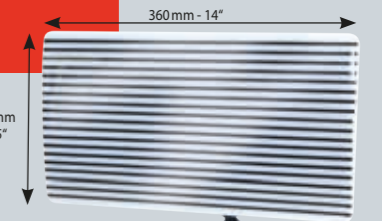

ULTRA LIGHT CARBON X40 PW EXELTOOLS

053175



GLUE PULLER PRO (Acier/Alu - Steel/Alu)

MADE IN FRANCE

Glue Lifter 057364

Glue Puller PRO 058699

Glue Puller PRO EXPORT 059160

061392

050952 (x6) Ø 16, Ø 21, Ø 32

250 W 052901

x10 050976

050983

BARRETTES ANNEAUX PLASTIQUE - Plastic Multipads Ösen-Klebe pads

22, 38, 37, 36, 50, 37

(x3) 048089, (x3) 048119, (x3) 048072, (x3) 048102, (x3) 048096

Ref. 050945

Colle Glue

156 mm

OPTIONS

Poignée de tirage 3 dents - Pulling handle 3 claws - Handzugkralle 3-fach 057326

057302

Marteau à inertie 500 g - Slide hammer 500 g - Gleithammer 500 g 057906

Jeu de 2 couteaux pour découpe de renforts collés - Set of 2 knives to cut glued reinforcements - 2-er Set Messer zur Klebepadentfernung 057913

Marteau à inertie 380 g - Slide hammer 380 g - Gleithammer 380 g 050051

Option 050969

acier-steel-Stahl 1.6 kg

KIT DÉBOSSÉLAGE SANS PEINTURE - Dent Pulling Kit (paintless) - Dellenausbeulhebel-Set

33 parts

051959

Paintless Dent Repair Kit

KIT DE 6 COINS DE FRAPPE - Set of 6 pencil punches - Beulenstemmer-Satz mit 6 Tefloneinsätzen

052888

MADE IN FRANCE

MARTEAU INERTIE PNEUMATIQUE - Pneumatic inertia hammer - Unterdruck-Schlaghammer

2,5kg

Ø 60 (x1), Ø 120 (x1), Ø 150 (x1)

051904

KIT COUSSINS GONFLABLES - Air Cushion Kit - Luftpolster-Spreizkissen-Satz

051942

MARTEAU À INERTIE À VENTOUSES (POMPAGE MANUEL) - PUMP AIR SUCTION SLIDE HAMMER - Man. Unterdruck-Schlaghammer

1,1kg

Ø 75 (x1), Ø 100 (x1), Ø 125 (x1)

048683



SPOT LIFT

MOBILE LIFTS

SPOT LIFT EASY

max Air 8 bar

SAFE EN 1494

max 2.2 t



064843

HEALTH CARE

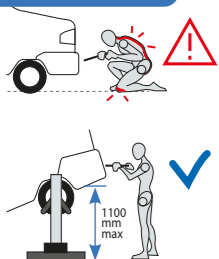

Haute stabilité - High stability

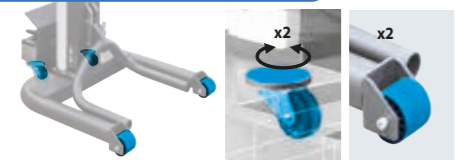

Included 220 bar 053588

NEW

SAFE EN 1494

OPTIONS

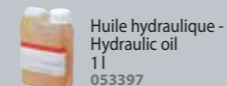

Huile hydraulique - Hydraulic oil 11 053397

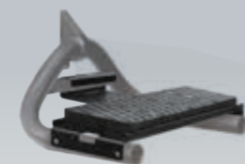

Outil de levage pour bas de caisse - Rocker panel lifting tool - Auflage für Seitenschweller 053236

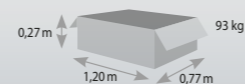

SPOT LIFT PRO

max Air 8 bar

SAFE EN 1494

max 2.2 t



053557

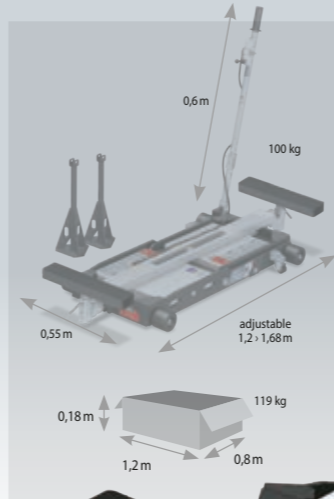

SPOT LIFT PRO MOB

max Air 8 bar

SAFE EN 1494

max 2.2 t



055896



60 cm (max) 14 cm (min)

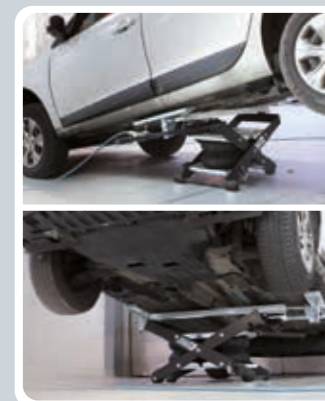

OPTIONS

Réhausseur pour 4x4 et utilitaires - Height adjuster for 4x4 & utility vehicles - Erhöhung f. 4x4 und Leicht-LKW



Patins - Pads for Audi & BMW (x 2) 053717

Rampes - Ramps 700 x 200 x 80 mm (x 2) 056787



OPTIONS

SPOT LIFT PRO MOB Réhausseur pour 4x4 et utilitaires - Height adjuster for 4x4 & utility vehicles - Erhöhung f. 4x4 und Leicht-LKW



Patins - Pads for Audi & BMW (x 2) 061606

Rampes - Ramps 700 x 200 x 80 mm (x 2) 056787

AUTO ROLL



min 500 mm max 1700 mm (AUTOROLL 1.0m) max 2240 mm (AUTOROLL 1.55m)

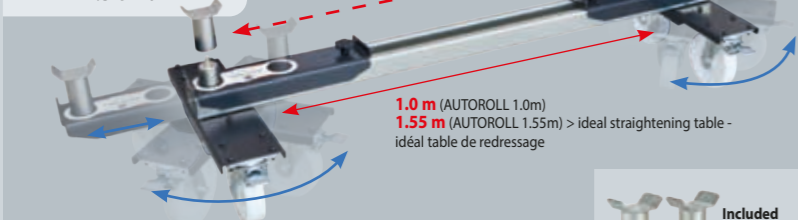

1.0 m (AUTOROLL 1.0m) 1.55 m (AUTOROLL 1.55m) > idéal straightening table - idéal table de redressement

AUTO ROLL 1.0 m / 1.2 t 059047



AUTO ROLL 1.55 m / 1.2 t 063839



AFTER LIFT AUTO ROLL

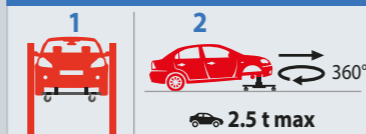

NEW 03 2021

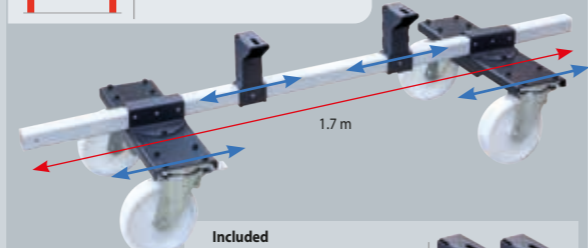

067967 45 Kg

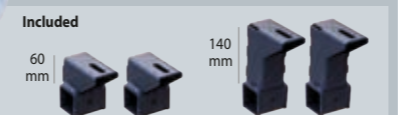

TABOURETS DE MANUTENTION - Wheel trolleys - Radhocker

048768

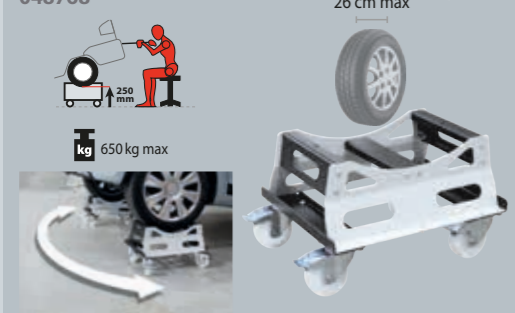

26 cm max

250 mm

650 kg max

CHARIOTS DE MANUTENTION PRISE SOUS ROUE - Wheel trucks - Kfz-Montagelift, fahrbar

Chariots hydrauliques (x 2) - Hydraulic jacks (x2) 053243

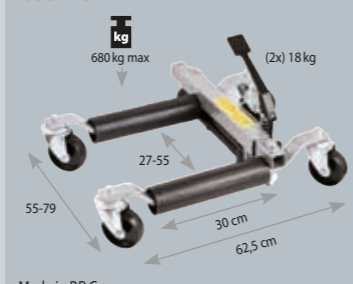

680 kg max

(2x) 18 kg

55-79

27-55

30 cm

62,5 cm

Made in P.R.C

Chariots mécaniques (x 2) - Mechanic jacks (x2) 064126

NEW



680 kg max

(2x) 15 kg

61-80 cm

34-71

33 cm

68 cm

Made in P.R.C

Option Support - Stand 064133



35

SPOT LIFT

MOBILE LIFTS

ERGO LIFT 650

220 V, 1~ **SAFE EN 1493**

max 2 t



Youtube

056817



220 V, 1 ph
0,75 kW

Included
Huile hydraulique -
Hydraulic oil
5l
062160



Pack ERGO LIFT 650
+ 4 Wheel trolleys (x4)

068544

NEW



QUICK LIFT L520E

062184

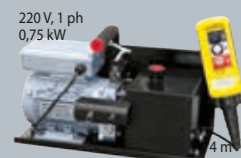

220 V, 1 ph
0,75 kW

Included
Huile hydraulique -
Hydraulic oil
5l
062160



Youtube

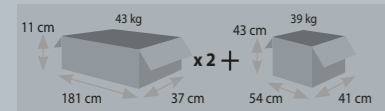

Made in China

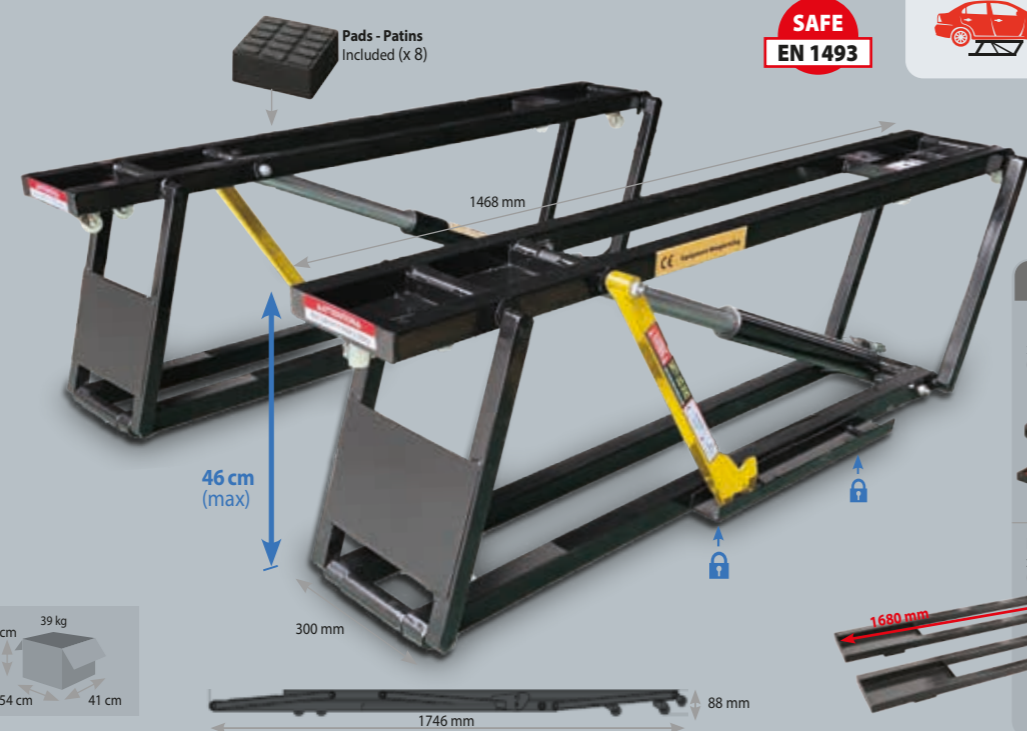

OPTIONS

Patins pour SUV -
Pads for SUV
x4
065017



Extensions 1680 mm
x 2
066328



NEW

TROLLEY IW1

max 6.5 bar

6.5 bar

063136



Youtube



Liberté de mouvement
- High dexterity

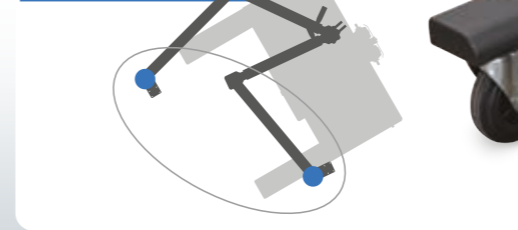

Grande maniabilité et stabilité
- High maneuverability & stability



OPTIONS

Huile hydraulique
- Hydraulic oil
1l
053397

Clé à choc
- Impact wrench
max 20 kg

Fixation
36 x 36 mm
→ 44 x 44 mm



**TRUCK
MAINTENANCE**



AIR JACKS



AIR JACK VAN 2T
058330

2T max

49 cm max
20.5 cm min
17 kg

AIR JACK CAR 2T
058323

2T max

32.6 cm max
13.2 cm min
14 kg



MANUAL WHEEL LIFT

Lève roue à treuil
- Wheel lift trolley
- Radmontage-Heber
061385

min : R13 / 135 / 65
max : R22 / 300 / 35
40 kg max

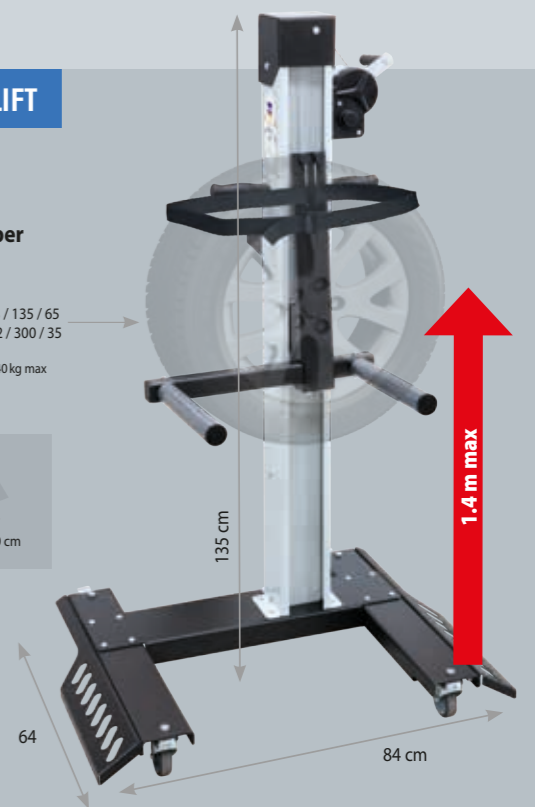
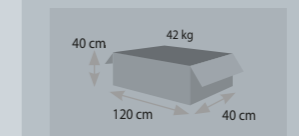

ÉVOLUTION TECHNOLOGIQUE

TECHNICAL IMPROVEMENTS - TECHNISCHE ENTWICKLUNG - MEJORAS TECNICAS

2004
 Facteurs d'évolution :
 • Challenge CO2 = faible poids
 • Crash test = ★★★★★
 • Anti corrosion = nouveaux revêtements
 • Esthétique et visibilité plus sophistiquées.

OLD SOLUTIONS
 Traditional machines
 180 daN max
 6 500 A max
 X clamps
 Ø 4 mm max

2022
 Entwicklungsfaktoren :
 • CO2 Challenge = geringes Gewicht
 • Crash-Test = ★★★★★
 • Anti-Korrosion = neue Beschichtung
 • Modernes Technik-Design.

GYS SOLUTIONS
 INVERTER Technology
 550 daN max
 14 500 A max
 X & C clamps
 Liquid cooled system
 Ø 10 mm

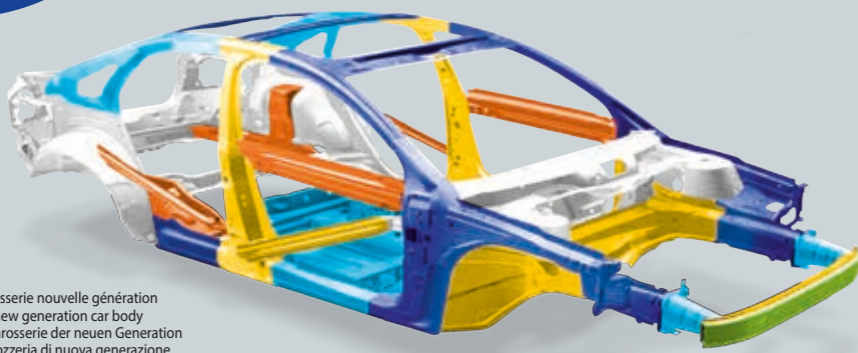
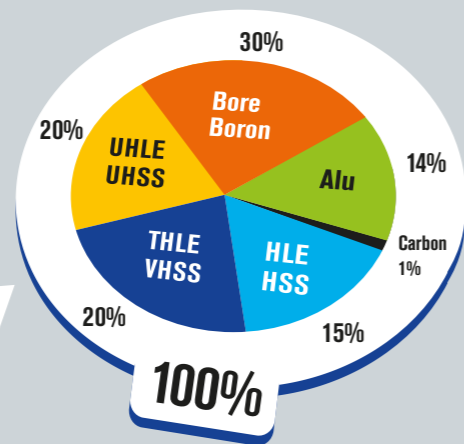
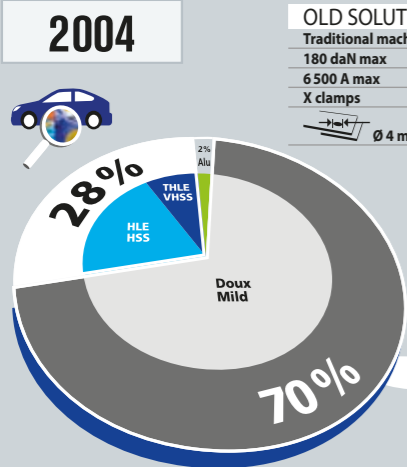

Exemple de carrosserie nouvelle génération
 • An example of new generation car body
 • Beispiel einer Karosserie der neuen Generation
 • Esempio di carrozzeria di nuova generazione

- Mild - Doux
- HSS - HLE
- VHSS - THLE
- UHSS - UHLE
- Bore - Boron
- Aluminium

RANGE

RANGE



	32 D	100 R	BP / BP-LG	PTI	PTI-G								
Doux - Mild	•	•	•	•	•								
HLE/THLE - HSS/VHSS	Difficult	•	•	•	•								
UHLE/BORE - UHSS/BORON	Difficult	Difficult	•	•	•								
Nombre de points - Number of spots	100	150	no limit	no limit	no limit								
	10	15	120	120	120								
Inverter Technology	—	•	•	•	•								
EMF Directive 2013/35/UE	—	—	BODY PROTECT TECHNOLOGY	•	•								
Système de refroidissement - Cooling system	AIR	AIR	LIQUID	LIQUID	LIQUID								
Régulation automatique - Automated regulation	irregular	constant	constant	constant	constant								
MODE AUTO	—	—	• (LC, LCX, LG)	•	•								
Pince - Clamp	X C X+C	• (32DX) • (32DC)	• (100R-X) • (100R-C) • (100R-CX)	• (BP.LX) • (BP.LC, BP.LG) • (BP.LCX)	—								
Transformer Inside Clamp	—	—	—	•	•								
Cables (L)	2,5 m	2,5 m	2,5 m	4 or 6 m	6 m								
Includes gun	•	•	•	option	option								
Cadence de soudage maximale (points/min) - Max welding frequency (spots/min)	10	10	10	10	10								
Fuse	400 V 200/208-240 V	32 A —	40 A —	32 A —	40 A —	50 A —	32 A —	40 A —	50 A —	60 A —	80 A —	100 A —	25 A (14 500 A) 16 A (11 500 A) 40A (14 500 A) 32A (11 500 A)

HOMOLOGATIONS PRODUITS

MANUFACTURER APPROVALS / COMPLIANCE - PRODUKT HOMOLOGATIONEN - PRODOTTI APPROVATI



Product	Volkswagen Group	Jeep	Mercedes	Smart	Opel	Renault	GM	Tata	Bosch	Kia	Jaguar / Land Rover	Ford USA	Honda USA	NIO
DENT PULLER														
GYSPT 2600/2700														
GYSPT 39.02/04, PRO230/400, EXPERT 200/400														
PROLINER/SPEEDLINER/DENTSTATION														
GYSPT ALU FV														
ARCPULL 200														
RESISTANCE SPOT WELDERS														
GYSPT 32D														
GYSPT INVERTER 100R														
GYSPT INVERTER BP-LX														
GYSPT INVERTER BP-LC-s7														
GYSPT INVERTER BP-LCX-s7														
GYSPT INVERTER BP-LG														
GYSPT EVOLUTION PTI-s7														
VAS 821 101 - Spot Welder														
BIVE TING														
GYPRESS 8T														
MIG / MAG														
T1 GYS AUTO														
T3 GYS AUTO														
AUTOPULSE 220-M3														
AUTOPULSE 320-T3														
VAS 821 005 - Pulse MIG Welder														
VAS 821 00580 023														
PLASMA														
CUTTER 25K/35KF														
CUTTER 30FV/45CT														
INDUCTIION														
GYSDUCTION AUTO														



BP BODYPROTECT TECHNOLOGY 2013/35/UE
 UNIQUE ELECTRO-MAGNETIC FIELD PROTECTION by GYS

®BODY PROTECT is a proprietary GYS technology that minimises electromagnetic fields created by the machine.
 Compliant : Directive 2013/35/UE
 Certified by : Laboratory EMITECH
 MADE IN FRANCE

LA SOLUTION GLOBALE - THE GLOBAL SOLUTION

Other technologies vs **GYS BODYPROTECT TECHNOLOGY**

B1: 10 < 25 cm (Norm : 3 cm max)	B1: 0 cm (Norm : 3 cm max)
B2: 25 < 35 cm (Norm : 30 cm max)	B2: 5 cm (Norm : 30 cm max) / 4 cm (Norm : 30 cm max)
B3: 35 cm (Norm : 20 cm max)	B3: 0 cm (Norm : 20 cm max)
B4: 35 cm (Norm : 20 cm max)	B4: 0 cm (Norm : 20 cm max)

BODYPROTECT



GYSPOT

SPOT WELDING

PORTASPOT 230

6 300 A 120 daN

Air cooled

230V
022256

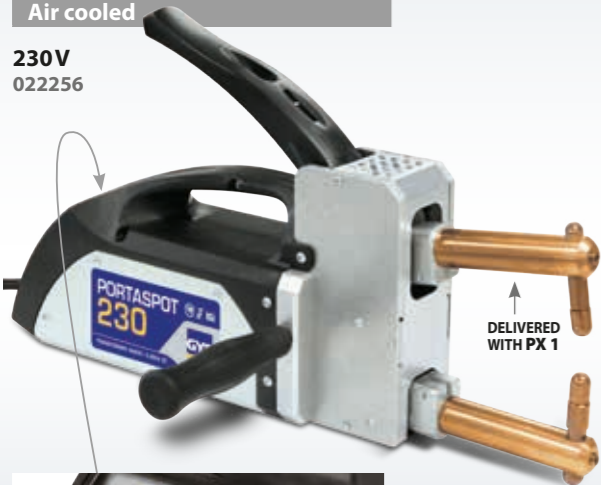

DELIVERED WITH PX 1



ARMS Ø 23 mm

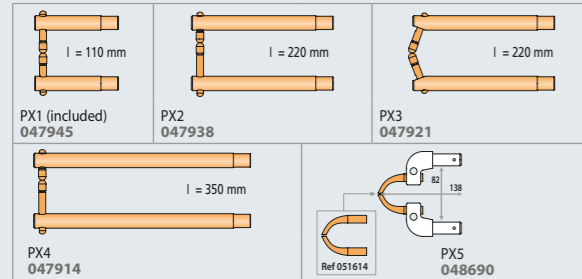

ELECTRODES

EX40 Short electrode 40 mm 047884	EX60 Medium electrode 60 mm 047891	EX80 Long electrode 80 mm 047907
-----------------------------------------	------------------------------------------	----------------------------------------

CAPS & ACCESSORIES



50/60 Hz	A	A	A	mm	V	m	mm ²	100% CU	(no arm) cm	kg
1 x 230V	16(D)	6 300	8 900	2+2	2,45	2,5	3x2,5 H05VVf	OK	36x29 x10	10

GYSPOT 32D-X

7 500 A 500 daN

Double pressure
Ø8 mm
6 kg (included RX1)

Air cooled

2 x 400V
019881

GYSPOT 32D-C

7 500 A 300 daN

Large opening
360°
Ø8 mm
4 kg (included RC1)

Air cooled

2 x 400V
019898

GYSPOT INVERTER 100R-X

10 000 A 500 daN

For mild steel, HSS, UHSS

Double pressure
Ø8 mm
6 kg (included RX1)

Air cooled

Traceability software
Save spot welding configuration and export data

3 x 400V
019911

GYSPOT INVERTER 100R-C

10 000 A 300 daN

For mild steel, HSS, UHSS

Large opening
360°
Ø8 mm
4 kg (included RC1)

Air cooled

Traceability software
Save spot welding configuration and export data

3 x 400V
019928

GYSPOT INVERTER 100R-CX

**10 000 A 500 daN (X)
300 daN (C)**

For mild steel, HSS, UHSS

Air cooled

Traceability software
Save spot welding configuration and export data

3 x 400V
022317



OPTIONS

- 050068
x10 (x20: 052239)
x6 (x6: 049994)
x18 (x6: 049987)
x18 (x6: 049970)
- 048935
x40 (x6: 049987)
- 050914
CARD
- Housse de protection - Protection cover - Schutzhaube 052260
- RC4 8 bar/120 daN, for 32D-C, 100R-C & 100R-CX 052253
- 051614

INCLUDED

	32D-X	32D-C	100R-X	100R-C	100R-CX
Monopoint Spot welding	■	■	■	■	■
Inertia hammer	■	■	■	■	■
Caps remover	■	■	■	■	■
Contact grease	■	■	■	■	■
Spotter box	■	■	■	■	■
Top support box	■	■	■	■	■
Cable support	■	■	■	■	■
RX1	■	■	■	■	■
RC1	■	■	■	■	■
RC2	■	■	■	■	■
RC3	■	■	■	■	■

	RX2	RX3	RC1	RC2	RC3
RX2	■	■	■	■	■
RX3	■	■	■	■	■
RC1	■	■	■	■	■
RC2	■	■	■	■	■
RC3	■	■	■	■	■

MADE IN FRANCE	CE MARK	50/60 Hz	A	A	A	mm	Uo	Cables		100% CU	cm	kg
								Air Cooled	Ø mm ²			
GYSPOT 32D.X GYSPOT 32D.C	62135	2 x 400V	32 (13 kVA) 40 (16 kVA)	7 500	10 500	3+3	1,2+3	11	2,2	200	OK	55 x 75 x 190
									2,5	150		
GYSPOT 100R.X GYSPOT 100R.C GYSPOT 100R.CX	62135	3 x 400V	32 (22 kVA) 40 (28 kVA) 50 (35 kVA)	10 000	—	3+3+3	1,5+3	16	2,5	200	OK	70 x 99 x 208
									2,5	150		
									—	8		

GYSPOT INVERTER AIR COOLED



GYSPOT INVERTER
BP-LX

13 000 A
550 daN

For mild steel, HSS, UHSS **Boron steel**

Double pressure
 Ø 10 mm
6,5 kg (included X1)

Liquid cooled

BP BODYPROTECT
Unique electro-magnetic field protection by GYS

Traceability software
Save spot welding configuration and export data

SD CARD MEMORY

019652

	019652	058804
	400V	
Monopoint/Spot 049291	▪	▪
Spotter box pro (p.10) 050075	▪	▪
Inertia hammer 049482 + 049802	▪	▪
X1 050501	▪	▪
X4A (x2) + X4B + X4C + X2 020733	▪	▪
Liquid cooling (10l) 052246	▪	(x3)



OPTIONS

050068
x10 (x20: 052239) x18 (x6: 049987)
x6 (x6: 049994) x18 (x6: 049970)

SD CARD 050914

048935 x40 (x6: 049987)



Liquide de refroidissement
Cooling liquid
Kühlmittel
Enfriamento líquido
Refrigeración líquida

052246

Housse de protection
- Protection cover
- Schutzhaube

050853

GYSPOT INVERTER
BP-LC-s7

13 000 A
550 daN

For mild steel, HSS, UHSS **Boron steel**

Double pressure
 Ø 10 mm
6,5 kg (included C1)

Liquid cooled

BP BODYPROTECT
Unique electro-magnetic field protection by GYS

Automatic C clamp
Energy Dynamic Control

Traceability software
Save spot welding configuration and export data

SD CARD MEMORY

020757

	020757	058798
	400V	
Monopoint/Spot 049291	▪	▪
Spotter box pro (p.10) 050075	▪	▪
Inertia hammer 049482 + 049802	▪	▪
Contact grease 050440	▪	▪
Caps remover 050846	▪	▪
Arm panel	▪	▪
C1 019140	▪	▪
C2 + C3 + C4 019126	▪	▪
C6 019775	▪	▪
Liquid cooling (10l) 052246	▪	(x3)



Included
Support haute stabilité
-High stability support
Compatible gyro

+

OPTION

GYRO 360° for BP-LC 051737

10-14 kg

MADE IN FRANCE 62135	50/60 Hz	A D curve	RMS A	U ₀ V	mm 3+3+3 1,5+3	Cables			100 % CU	cm	kg
						Liquid / Air Cooled	↔ m	Ø mm ²			
GYSPOT BPLX	3 x 400V	32 (22 kVA)	13 000	16	3+3+3 1,5+3		2,5	200	OK	65 x 80 x 205	150
GYSPOT BPLC-s7		40 (28 kVA) 50 (35 kVA)					2,5	150			



GYSPOT INVERTER
BP-LCX-s7

13 000 A
550 daN

For mild steel, HSS, UHSS Boron steel

Double pressure
Ø 10 mm
6,5 kg (included X1 or C1)

Liquid cooled

BP BODYPROTECT
2013/35/UE Unique electro-magnetic field protection by GYS

EDC Automatic C clamp
Energy Dynamic Control

Traceability software
Save spot welding configuration and export data

020948



OPTIONS

GYRO 360° for BP-LCX 051737
10-14 kg

Included
Support haute stabilité
+High stability support
Compatible gyro
+

OPTIONS

050068 x10 (x20: 052239) x18 (x6: 049987)
x6 (x6: 049994) x18 (x6: 049970)

048935 x40 (x6: 049987)

SD CARD 050914
Liquide de refroidissement Cooling liquid Kühlmittel Enfrimiento líquido Refrigeração líquida
052246

Housse de protection - Protection cover - Schutzhaube
for BP & PTI
050853

GYSPOT INVERTER
EVOLUTION PTI

14 500 A
550 daN

For mild steel, HSS, UHSS Boron steel

16 > 25 A
Double pressure
Ø 10 mm
9,9 kg (included C1)

TRANSFORMER INSIDE

Liquid cooled

EDC Automatic C clamp
Energy Dynamic Control

Traceability software
Save spot welding configuration and export data

020894

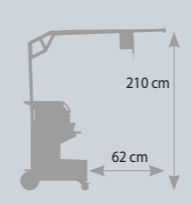

Very light
9,9 kg

10-14 kg
059696



OPTION

Complete gun kit 067318

GYRO 360° for PTI 051720

200 mm² 1.6 m
300 mm² 1m

	020948
	220V

	4M 022188	4M 020894	4M 067998
	6M 022195	6M 020900	
	220V	400V	
			(x3)

MADE IN FRANCE 62135	50/60 Hz	A D curve	RMS A	Uo V	mm	Cables			100% CU	cm	kg	
						Ø 200 mm², liquid	Ø 150 mm², air	8 m, 4x6 H07RNF (BP 220V: 4x6AWG)				
GYSPOT BP-LCX-s7 220 V	3 x 200 208 220 240	60 (21-25 kVA) 80 (28-33 kVA) 100 (35-41 kVA)	10 500 11 000 12 000 12 500	15 15,5 17 18	3 + 3 + 3	1,5 + 3	2,5 m, Ø 200 mm², liquid	2,5 m, Ø 150 mm², air	8 m, 4x6 H07RNF (BP 220V: 4x6AWG)	OK	65 x 80 x 205	170
GYSPOT EVOLUTION PTI-s7	3 x 400 V	16 (11 kVA) 20 (14 kVA) 25 (17 kVA)	11 500 14 500	8	3 + 3 + 3	1,5 + 3	4 m, liquid	OPTION 067318: 1.6 m, Ø 200 mm²	8 m, 4x4 H07RNF	OK	65 x 80 x 230	91
GYSPOT EVOLUTION PTI-s7 220 V	3 x 200 208 220 240	30 (10-12 kVA) 40 (14-16 kVA) 50 (17-21 kVA)	12 500 13 000 14 500 14 500	6,95 7,2 8 8,3	3 + 3 + 3	1,5 + 3	4 m, liquid	8 m, 4xAWG8 (SOOW)				

FOR GYSPOT 32D-X, 100R-X, BP-LX, BP-LCX**550 daN****6,5 kg** including X1

- DOUBLE PRESSURE
- LIQUID COOLED / REFRIGERATION LIQUIDE
- Ø 10 mm

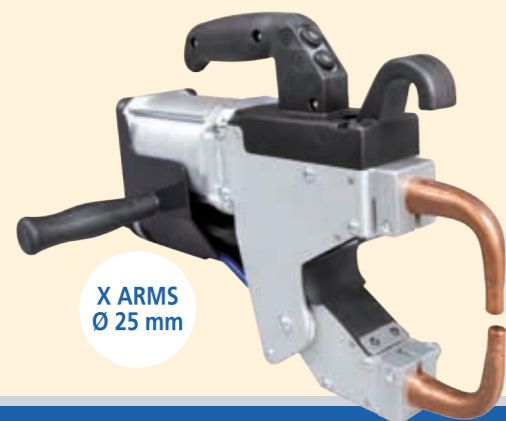
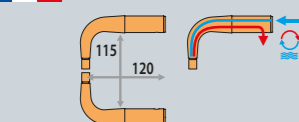
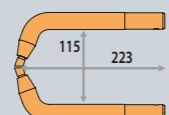
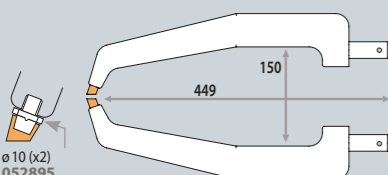
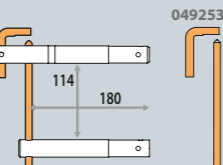
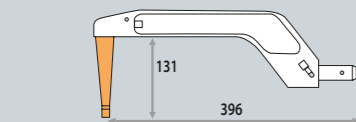
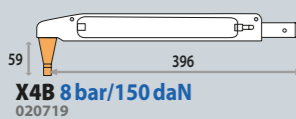
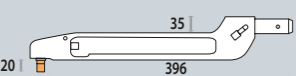
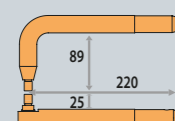
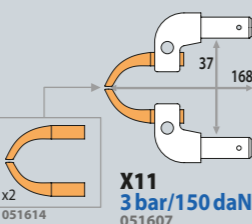
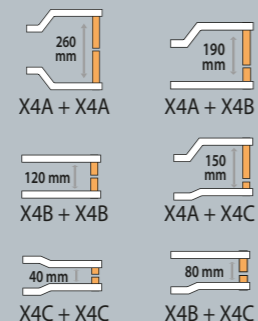

MADE IN FRANCE

**X ARMS**
Ø 25 mm**X Arms - Caps Ø13 mm****X1 8 bar/550 daN**
050501**X2 8 bar/400 daN**
050518**X4 8 bar/120 daN**
050532**X5 8 bar/200 daN**
050549**X4A 8 bar/150 daN**
020702**X4B 8 bar/150 daN**
020719**X4C 8 bar/150 daN**
020726**X6 8 bar/400 daN**
050587**X4 (A, B & C) combinations****X11**
3 bar/150 daN
051607**X ARMS PANELS****X4A (x2) + X5 + X2**
022324X arms support
021471**X4A (x2) + X4B + X4C + X2**
020733X arms support
021471**Remote control (BP)**Digital screen control
Change Mode & Parameters

X clamp control



C clamp control

**C ARMS PANELS**C2
+ C3
+ C4
019126C2
+ C3
+ C4
021457C2
+ C3
+ C4
060821C2 + C3 + C5 + C6 = 051553
C2 + C3 + C5 + C6 + C9 = 050044C2 + C3 + C6 + C12 + C9 = 061286
C2 + C3 + C6 + C12 + C9 = 061316**FOR GYSPOT BP-LCX, BP-LC****550 daN****6,5 kg** including C1

- DOUBLE PRESSURE
- LIQUID COOLED / REFRIGERATION LIQUIDE
- Ø 10 mm



MADE IN FRANCE

**550 daN****9,9 kg** including C1

- DOUBLE PRESSURE
- AIR COOLED + LIQUID COOLED / DOUBLE REFRIGERATION AIR + LIQUIDE
- Ø 10 mm

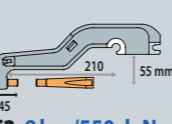
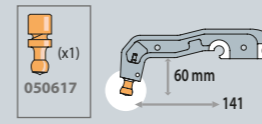
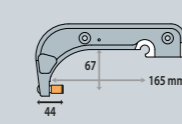
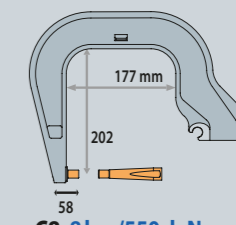
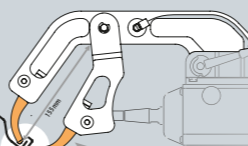
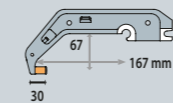
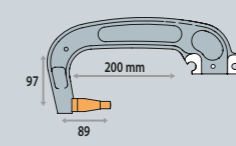
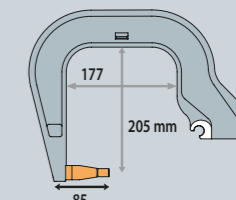
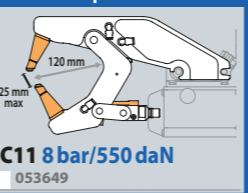
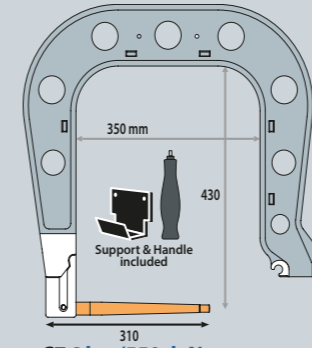
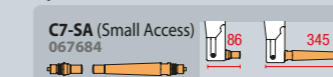
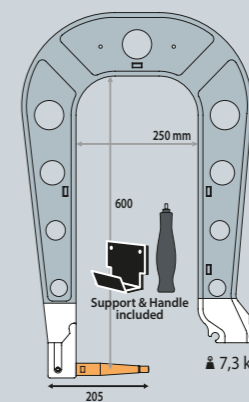
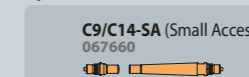
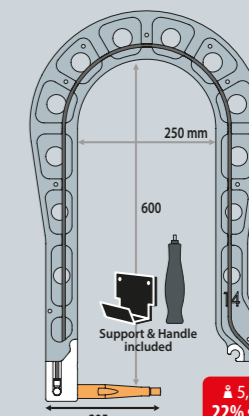
Arm lock pin
062405**C Arms - Caps Ø13 mm****Classic arms****CLASSIC FINISH****Bras isolés - Isolated arms - Isolierte Bügel****ELECTRICAL INSULATION****C2 8 bar/550 daN**
022386
019133**C6 8 bar/300 daN**
022409
019775**C12 8 bar/550 daN**
022997**C8 8 bar/550 daN**
021440
020016**C10 4 bar/150 daN**
051638**C5 8 bar/550 daN**
022393
019294**C1 8 bar/550 daN**
021402
019140**C3 8 bar/550 daN**
021419
019157**X Arms - Caps Ø13 mm****C11 8 bar/550 daN**
053649**C7 8 bar/550 daN**
021433
020009**Option for C7****C7-SA (Small Access)**
067684**C9 8 bar/550 daN**
020078**Option for C9 & C14****C9/C14-SA (Small Access)**
067660**C14 8 bar/400 daN**
023543▲ 5,7 kg
22% saved

023543



SPOT WELDING

GENIUS

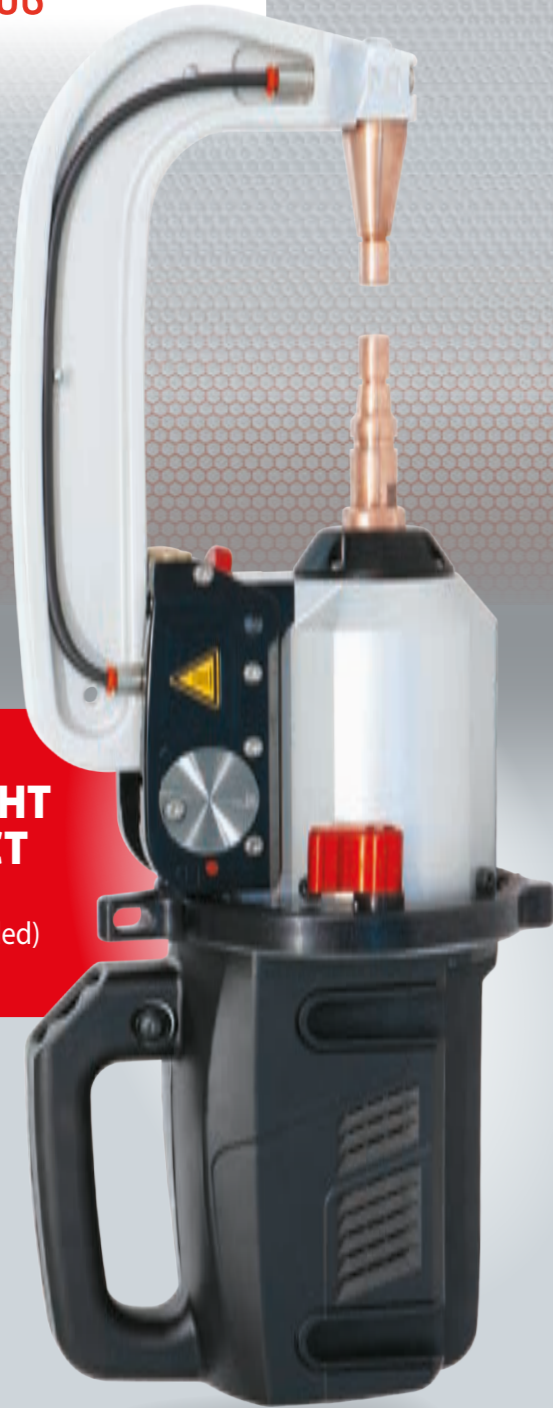

MADE IN FRANCE

ULTRA LIGHT & COMPACT
6.5 kg
(Gyro & G1 included)

550 daN
LIQUID COOLED
REFROIDISSEMENT LIQUIDE
Ø 10 mm

6.5 kg
(Gyro & G1 included)



FAST OPEN XL

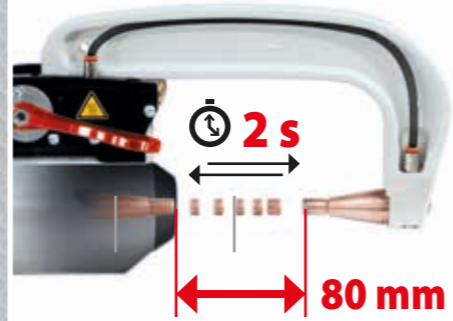

EASY



GYRO INTEGRATED



PERFECT ELECTRICAL CONNECTION



AUTO



GYSPOT INVERTER BP-LG

13 000 A
550 daN

For mild steel, HSS, UHSS Boron steel

BP BODYPROTECT
Unique electro-magnetic field protection by GYS

Traceability software
Save spot welding configuration and export data

023451

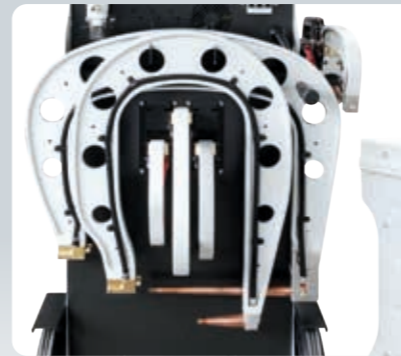

	023550	023451	023499
Gyspot BP-LG	220V	400V	
Monopoint/Spot 049291	▪	▪	▪
Spotter box pro (p.10) 050075	▪	▪	▪
Inertia hammer 049482 + 049802	▪	▪	▪
Caps remover 050846	▪	▪	▪
Arm support	▪	▪	▪
G1 022768	▪	▪	▪
G2 + G3 + G4 022898	▪	▪	▪
Liquid cooling (10l) 052246			(x3)

OPTIONS

<p>x40 (x6 : 049987) 048935</p>	<p>SD CARD 050914</p>	<p>Liquide de refroidissement Cooling liquid Kühlmittel Enfriamento líquido Refrigeración líquida</p> <p>052246</p>	<p>Housse de protection - Protection cover - Schutzhaube</p> <p>for BP & PT1</p> <p>050853</p>	<p>10-14 kg 059696</p>
-----------------------------------------	---------------------------	-------------------------------------------------------------------------------------------------------------------------------------	------------------------------------------------------------------------------------------------------------	----------------------------

MADE IN FRANCE	50/60 Hz	+AM+ A D curve	RMS A	Uo V	mm				Cables	100% CU	cm	kg													
					3	4	5	6																	
GYSPOT BP.LG 220 V	3 x	60 (21-25 kVA) 80 (28-33 kVA) 100 (35-41 kVA)	10 500 11 000 12 000 12 500	15 15,5 17 18	3 + 3 + 3	1,5 + 3	2,5 m, Ø 200 mm ² , Liquid	2,5 m, Ø 150 mm ² air	8 m 4x16 mm ² (6AWG) 500W	OK	65 x 80 x 205	160													
													GYSPOT BP.LG 400V	3 x 400V	32 (22 kVA) 40 (28 kVA) 50 (35 kVA)	13 000	16	3 + 3 + 3	1,5 + 3	2,5 m, Ø 200 mm ² , Liquid	2,5 m, Ø 150 mm ² air	8 m 4x6 mm ² H07BNF	OK	65 x 80 x 205	160

FAST OPEN XL

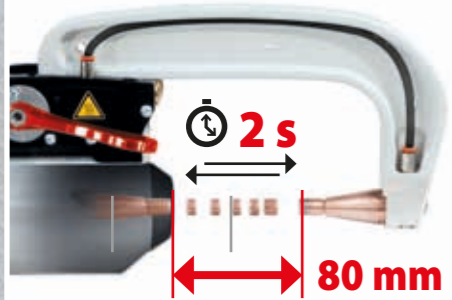

GYRO INTEGRATED



PERFECT ELECTRICAL CONNECTION

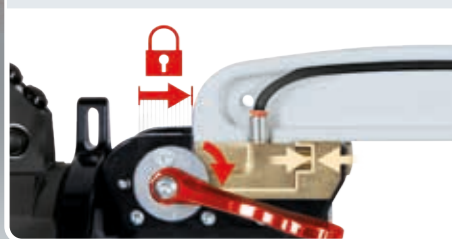

AUTO



NEW



MADE IN FRANCE



TRANSFORMER INSIDE

550 daN

LIQUID COOLED
REFROIDISSEMENT LIQUIDE

Ø 10 mm

11.3 kg
(Gyro & G1 included)

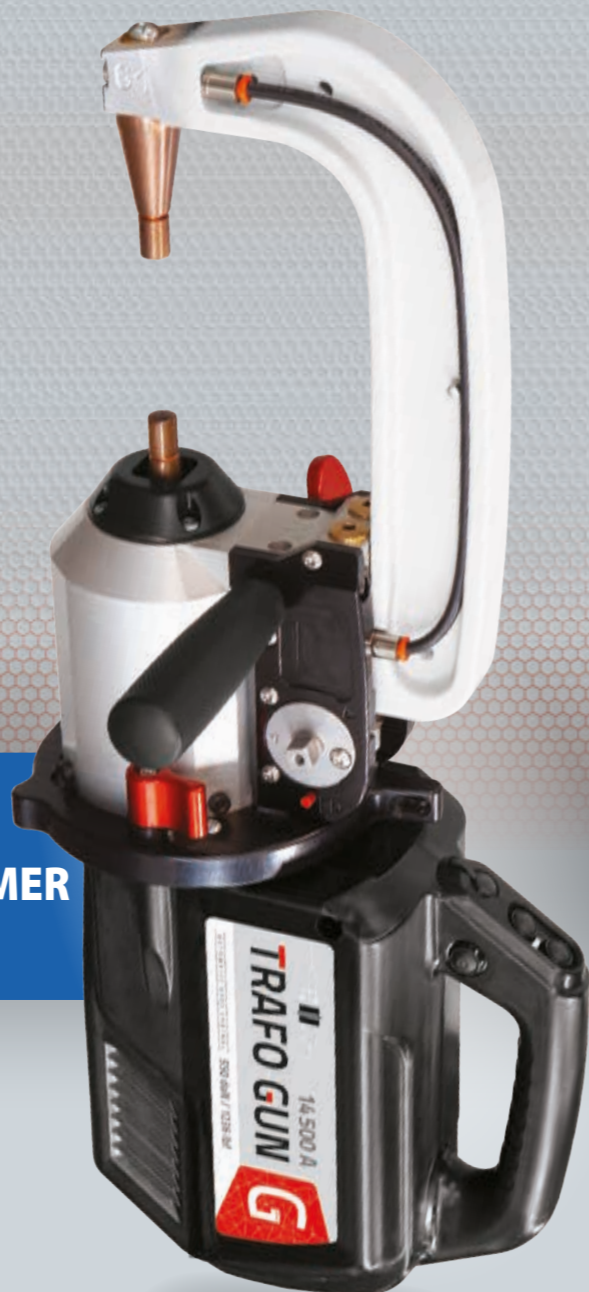

**Potence électrique - Motorised cable support
- Elektrisch verstellbarer Kabelsupport**



Ergonomic

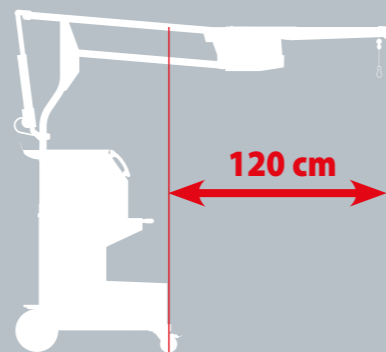

OPTIONS

048935	050914	052246	050853
--------	--------	--------	--------

**GYSPOT INVERTER
PTI-G**

14 500 A
550 daN

For mild steel, HSS, UHSS **Boron steel**

TRANSFORMER INSIDE

Traceability software
Save spot welding configuration and export data



	024854	024878	068001	024892
Gyspot BP-LG	220V	400V	480V	
Monopoint/Spot 049291	▪	▪	▪	▪
Spotter box pro (p.10) 050075	▪	▪	▪	▪
Inertia hammer 049482 + 049802	▪	▪	▪	▪
Caps remover 050846	▪	▪	▪	▪
Arm support	▪	▪	▪	▪
G1 022768	▪	▪	▪	▪
G2 + G3 + G4 022898	▪	▪	▪	▪
Kit gun 067226	▪	▪	▪	▪
Liquid cooling (10l) 052246			(x3)	

Included
Cable support
ULTRA RESISTANT



ELECTRIC MOTOR

NEW

Control
Commande

**Grande stabilité
- High stability**

OPTIONS

Kit gun PTI-G 067226 300 mm² 1.8 m 300 mm² 1m



MADE IN FRANCE 62135	50/60 Hz	-AM- A D curve	RMS A	Uo V	mm		Cables	cm	kg		
					↕	↔					
GYSPOT PTI.G 220 V	3 x	200 208 220 240	50 (17-21 kVA)	12 500	6.6	3 + 3 + 3	1,5 + 3	6 m, Liquid	8 m 4xAWG8 (500W)	71 x 90 x 200	100
				13 000	6.9						
				14 500	7.3						
GYSPOT PTI.G 400V	3 x	400V	25 (17 kVA)	14 500	7	3 + 3 + 3	1,5 + 3	6 m, Liquid	8 m 4x4 mm ² H07RNF	71 x 90 x 200	100
				14 500	7.9						
GYSPOT PTI.G 480V	3 x	480V	20 (17 kVA)	14 500	7	3 + 3 + 3	1,5 + 3	6 m, Liquid	8 m 4xAWG12 (500W)	71 x 90 x 200	100

FOR GYSPOT BP-LG & PTI-G

G Arms - Caps Ø13 mm

Bras isolés - Isolated arms - Isolierte Bügel

NEW Reversible
for G1, G3, G4, G5, G8 & G10

Kit de maintenance connecteurs pince G - Connectors maintenance kit for G clamp 067295

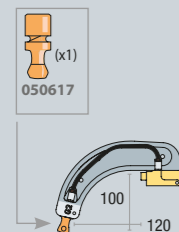

G2
8 bar/300 daN
022775

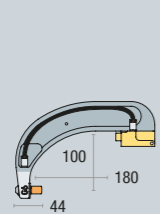

G6
8 bar/550 daN
022812

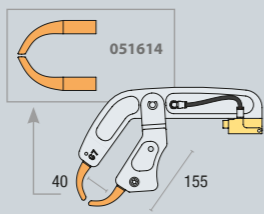

G7
4 bar/150 daN
022829

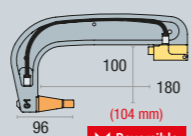

G1
8 bar/550 daN
022768

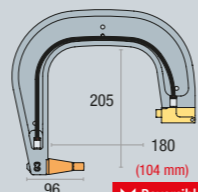

G3
8 bar/550 daN
022782

Option for G1 & G3
G1/G3-SA (Small Access)
067653 (for arms > 02/2021)

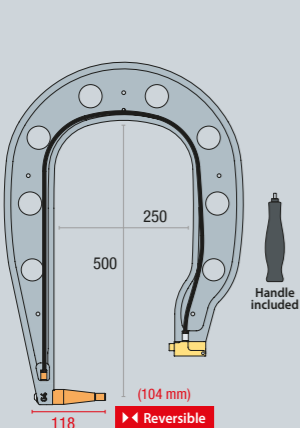

G4
8 bar/550 daN
022799

Option for G4
G4-SA (Small Access)
064478 (for arms < Oct 2019)

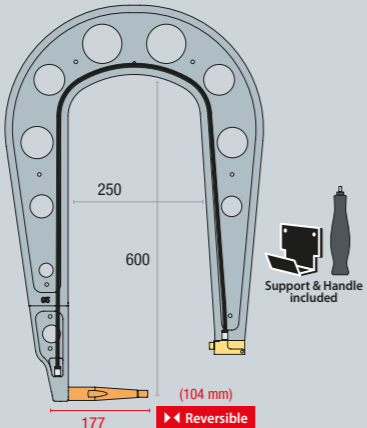

G5
8 bar/550 daN
022805

Option for G5
G5-SA (Small Access)
067660

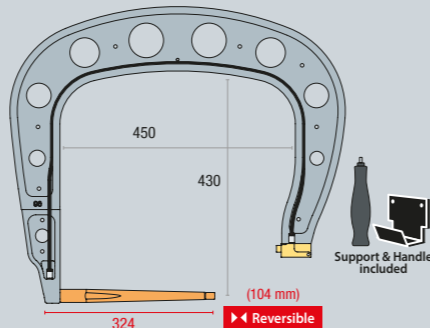

G8
8 bar/550 daN
022836

Option for G8
G8-SA (Small Access)
067677

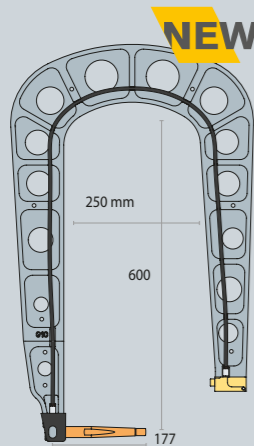

G10
8 bar/400 daN
067165

5 kg
20% saved

X1
(Included with G9)
050501
140
115
550 daN

G9
8 bar/550 daN
022881

G9 + Clamp extension
for G-Clamp S/N < Oct. 2019
063419

Option Compatible **X2**
050518
300 daN

Option Compatible **X6**
050587
300 daN

Option SD card 050914

Option PCB 97449C

BREVETÉ PATENTÉ

G > X
UNIQUE SYSTEM
by GYS

AUTOMATIC WELDING
FOR X1, X2 & X6

**G ARMS
PANELS**

G2
+ G3
+ G4
022898

G2
+ G3
+ G5
063297



CONSUMMABLES X & C - X & C Consumables

- Type A Cor X clamp Ø 13 mm (x6) 049987
- Type B Cor X clamp Ø 13 mm / Ø 5 mm (x6) 055506
- Type D Cor X clamp Ø 13 mm (x10) 058507
- TYPE F For single sided gun Ø 13 mm (x6) 049970
- TYPE G Ø 13 mm (x10) 059672
- Caps inclinés - Beveled X2, X4, C11 arms Ø 13 mm (x6) 049994

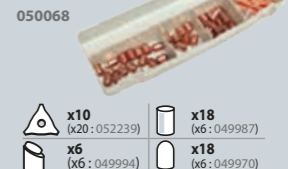

AFFUTEUR DE CAPS PNEUMATIQUE - Pneumatic cap grinder



AFFUTEUR DE CAPS - Cap grinder

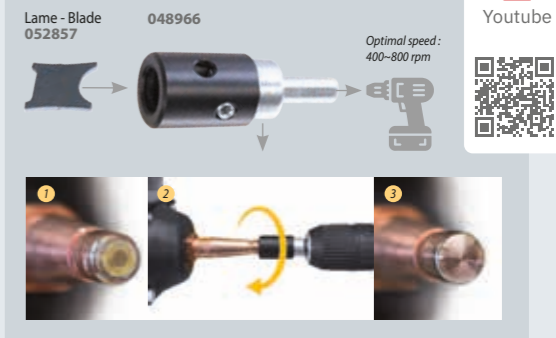

BANC DE TRACTION ARRACHE TÔLE - Steel sheet traction bench - Blech-Zugbank zur Festigkeitsprüfung



VALISE TEST SOUDURE HLE / THLE - Weld test kit - Schweißtestkit im Hartschalenkoffer



PROTECTION ANTI-ARC 12 V - Anti-arc protection 12V - Lichtbogenschutz 12V - Protección anti-arco 12V



GYRO 360°

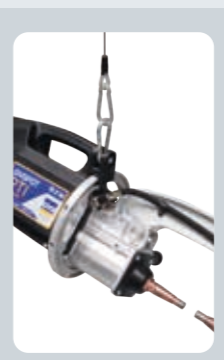

ÉCHANTILLONS DE TÔLES - Sheets set



CAPTEUR D'EFFORT - Electrode force sensor



KIT DE PURGE RÉSERVOIR - Tank draining kit - Kit zur Tankentleerung



CARTE MÉMOIRE SD - SD memory card



HOUSSE DE PROTECTION - Protection cover - Schutzhaube



LIQUIDE DE REFROIDISSEMENT - Cooling liquid - Kühlmittel - Enfriamiento líquido - Refrigeração líquida





RIVETING

PNEUMATIC HYDRAULIC



OPTIONS



Support Riveteuse pour changements d'accessoires (bras & matrice)
- Riveting machine support for changing accessories (arms & dies)
- Supportständer
↳ 28 x 40 x 21,5 cm
054158



Chariot-Trolley
↳ 51 x 82 x 74 cm
054233



Chariot+Support-Trolley+Support
↳ 51 x 122 x 74 cm
055391

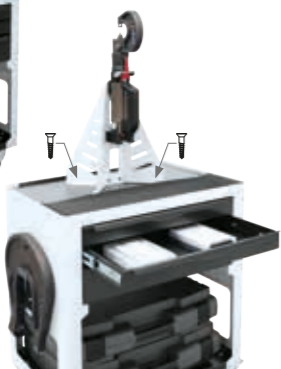

Capteur d'effort
for GYSPRESS 10T, 8T & 10T PushPull, 10T PP CONTROL
062115



Hydraulic body wrenches
for GYSPRESS 10T, 10T PushPull, 10T PP CONTROL (x 2)
067325



POWER 10t



Levier de décharge
- Discharge lever
- Auslösehebel



Contrôle de la vitesse
- Speed control
- Regelung
Werkzeuggeschwindigkeit



Contrôle de la pression
- Pressure control
- Druckregelung

GYSPRESS 10T

6.5 bar 100 kN

10t



HR110
063310



Strap-Sangle-Gurt

063303



XT11.21 - Extension
for HR110 & HR210
058644



HR arm locker



Standard 8T/10T tool box
053694



Poignée-Handle-Griff



6 x 50 rivets RAP -
Nieten SPR
048706

PUSH PULL SYSTEM by GYS



Sélection Push/Pull - Push/Pull selection



GYSPRESS 8T PUSH PULL

GYSPRESS 10T PUSH PULL



POWER 8t

UNIQUE PUSH PULL SYSTEM by GYS



Contrôle de la vitesse
- Speed control
- Regelung
Werkzeuggeschwindigkeit



Contrôle de la pression
- Pressure control
- Druckregelung

GYSPRESS 8T PUSH PULL

8 bar 80 kN

8t



HR15
054219



Strap-Sangle-Gurt

056893



XT11.21 - Extension
for HR110 & HR210
058644



HR arm locker



Standard 8T/10T PushPull
tool box
058361



Poignée-Handle-Griff



6 x 50 rivets RAP -
Nieten SPR
048706

GYSPRESS 10T PUSH PULL

6.5 bar 100 kN

10t



HR110
063310



Strap-Sangle-Gurt

063853



XT11.21 - Extension
for HR110 & HR210
058644



HR arm locker



Standard 8T/10T PushPull
tool box
058361



Poignée-Handle-Griff



6 x 50 rivets RAP -
Nieten SPR
048706

MADE IN FRANCE	AIR BAR	PRESSURE CONTROL	SPEED CONTROL	↕	⚖	↕	⚖	
				cm	kg	cm	kg	
GYSPRESS 10T	6.5 bar = 10 t (maxi 10 bar)	0 > 6.5 bar	+ -	39.5 x 180	6.2 (HR110 included)	58 x 48 x 15	11.8	
GYSPRESS 8T PUSH PULL	8 bar = 8 t (maxi 10 bar)	0 > 8 bar	+ -	39.5 x 180	5.8 (HR15 included)	58 x 48 x 15	11.7	
GYSPRESS 10T PUSH PULL	6.5 bar = 10 t (maxi 10 bar)	0 > 6.5 bar	+ -	39.5 x 180	6.7 (HR110 included)	58 x 48 x 15	12.5	





GYPRESS

SYNERGIC RIVETING WORKSTATION

PNEUMATIC HYDRAULIC



UNIQUE 100%
No air inclusion
maintenance free, no oil refill

ACCESSIBILITY

10 languages

- FR ES CN
- GB CZ JP
- DE NL
- IT RU

★★★★★
SYNERGIC RIVETS SETTINGS

Main panel

Setup instructions



Results



3 MODES

- MANUAL
- SYNERGIC
- CAR MANUFACTURERS

CAR MANUFACTURERS COMPATIBILITY

- ✓ VW GROUP
- ✓ MERCEDES-BENZ
- ✓ BMW
- ✓ TESLA
- ✓ FERRARI
- ✓ FORD
- ✓ JAGUAR / LAND ROVER

CONNECTIVITY

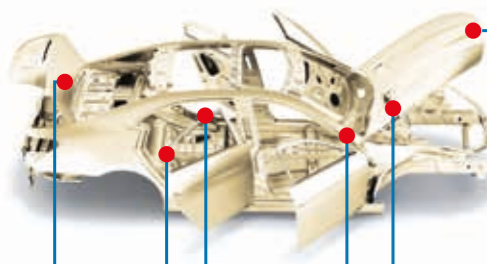

TRACEABILITY

History data export

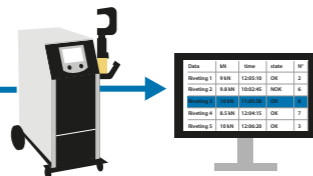

SOFTWARE UPDATE

Gyspress evolutions

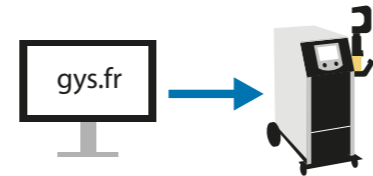

UNIQUE PUSH PULL SYSTEM by GYS

PUSH PULL SYSTEM by GYS

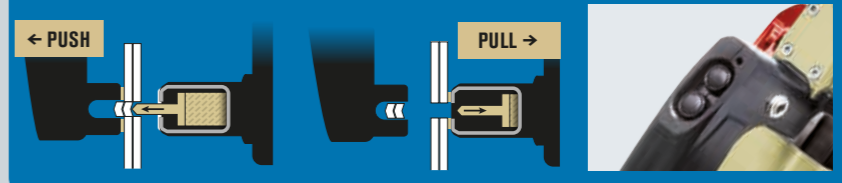

Selection Push/Pull - Push/Pull selection

NEW 02 2021

REGULATED PRESSURE CONTROL

POWER 10t



Levier de décharge - Discharge lever - Auslösehebel



WORKSTATION GYPRESS 10T PP CONTROL

6.5 bar | 100 kN

10t

063860

included

- HR110 063310
- XT11.21 - Extension for HR110 & HR210 058644
- Standard 8T/10T PushPull tool box 058361
- 6 x 50 rivets RAP - Nieten SPR 048706
- Strap-Sangle-Gurt
- HR arm locker
- Poignée-Handle-Griff

OPTIONS

Capteur d'effort
for GYPRESS 10T, 8T & 10T PushPull, 10T PP CONTROL 062115



Youtube



Hydraulic body wrenches for GYPRESS 10T, 10T PushPull, 10T PP CONTROL (x2) 067325

MADE IN FRANCE WORKSTATION GYPRESS 10T PP CONTROL	230 V	AIR BAR 6.5 bar = 10 t (maxi 10 bar)	PRESSURE CONTROL 0 > 6.5 bar	SPEED CONTROL + -	cm	kg
					N/A	N/A (HR110 included)



BRAS DE RIVETAGE - Riveting arms - Stanznietbügel

	HR110	HR210	HR310 8t	HR310 10t
Compatibility	063310	063327	065963	063334
GYPESPRESS 8T	✓	✓	✓	—
GYPESPRESS 10T	✓	✓	—	✓
GYPESPRESS 8T PUSH PULL	✓	✓	—	✓
GYPESPRESS 10T PUSH PULL	✓	✓	—	✓
GYPESPRESS 10T CONNECT	✓	✓	—	✓

KIT HR210 + HR310 8t
065970

KIT HR210 + HR310 10t
064089

included XT31-92 (92 mm) 057128

included XT31-78 (78 mm) 058637

XT31-40
Rallonges bras HR310 pour point milieu - HR310 arm extension for middle point
x2

066335

RIVETS AUTOPERÇANTS (RAP) - Self piercing rivets (SPR) - Stanznieten

Steel - Acier - Stahl	Complete box 048706							
	Ø 3,3 x 3,5 mm x 50	Ø 3,3 x 4 mm x 50	Ø 5,3 x 4 mm x 50	Ø 5,3 x 5 mm x 50	Ø 5,3 x 6 mm x 50	Ø 5,3 x 8 mm x 50	Ø 5,3 x 7 mm	Ø 5,3 x 9 mm
	x 200 048232	x 200 048249	x 100 048256	x 100 048263	x 100 048270	x 100 048225	x 100 048638	x 100 048645

POINTEAU CENTREUR - Special center punch - Spezialkörner

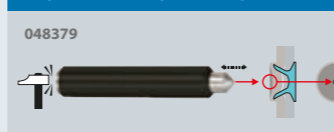

MATRICES - Dies - Matrizen

Pose de rivets auto-perçants - Application of self-piercing rivets - Stanzniet-Verpressen

Pose de rivets pleins - Application of solid rivets - Vollniet-Verpressen

Pose de rivets Flow-Form - Application of Flow-form rivets - Setzen v. Fließformnieten

Extraction de rivets - Extraction of rivets - Niet-Auspressen

Percage et formage des tôles pour rivets pleins - Metal sheet punching and shaping - Vollniet-Lochstanzen/Prägen

3-5.2 bar RAP Ø3.3

4.7-5.8 bar RAP Ø5.3

5.3-6.4 bar RFF Alu Ø6

5.8-7 bar RFF Steel Ø6

6.5-8 bar RFF Steel Ø8

8 bar Eject & Drilling

A1 x1 055698	G2 x1 057180	H7 x1 068292	F3 x1 055797	E2 x1 055766	D15 x1 056077	T5 x1 058019
A2 x1 055704	G3 x1 057197	H8 x1 068308	F4 x1 055803	E1+E2 x1 054318	D16 x1 056084	T7 x1 058033
A1+A2 x1 054295	G4 x1 057203	S3 x1 057043	F5 x1 055810	E3 x1 057005	ST1 x1 058071	T8 x1 058040
B1 x1 055711	G5 x1 057210	S7 x1 057074	D1 x1 055971	E4 x1 057012	ST2 x1 058088	T10 x1 058064
B2 x1 055728	G6 x1 057227	S8 x1 057081	D2 x1 055988	E5 x1 057029	ST3 x1 066397	T12 x1 066373
B1+B2 x1 054301	H1 x1 068230	D8 x1 056039	D3 x1 055995	E6 x1 057142	T1 x1 057098	T13 x1 066380
B3 x1 055735	H2 x1 068247	D9 x1 056046	D4 x1 055742	E7 x1 057159	T2 x1 059078	T14 x1 066410
B4 x1 059016	H3 x1 068254	D17 x1 055681	D13 x1 055759	E8 x1 057166	T11+T2 x1 054707	T15 x1 066427
B5 x1 059023	H4 x1 068261	D17 x1 055681	D17 x1 055681	E9 x1 058606	D10 x1 055674	T16 x1 066434
B6 x1 059030	H5 x1 068278	F2 x1 055780	E1 x1 055865	E10 x1 058613	D11 x1 056060	
G1 x1 057173	H6 x1 068285	F1+F2 x1 054714	E11 x1 058620	E11 x1 058620	D12 x1 056053	

BOÎTES MATRICES STANDARDS - Dies boxes - Standard-Matrizensätze

STANDARD 8T/10T Included in GYPESPRESS 10T 053694

STANDARD 8T/10T PUSH PULL Included in GYPESPRESS 8T Push Pull & 10T Push Pull 058361

KIT RMB PP05
Low pressure
Idéal aluminium, aciers doux - Ideal for aluminum, mild steel 066366

KIT RMB 08 PREMIUM
HIGH pressure
Idéal aciers durs, Boron - Ideal for UHSS, Boron 066403

Included XT31-60 - 60 mm extension for HR3 (use with ST1, T5, T7) 057135

BOÎTES MATRICES CONSTRUCTEURS - Car manufacturers boxes - OEM-Matrizensätze

Compatibility	BMW	Jaguar Land Rover	VW Group	Mercedes-Benz	Ford	Ferrari	Tesla
GYPESPRESS 8T	RMB 01	RMB 02	RMB 03	RMB 04	RMB 05	RMB 06	—
GYPESPRESS 10T	RMB 01	RMB 02	RMB 03	RMB 07	RMB PP02	RMB 06	RMB 09 & RMB PP03
GYPESPRESS 8T PUSH PULL	RMB 01	RMB 02	RMB 03	RMB PP01	RMB PP02	RMB 06	RMB 09 & RMB PP03
GYPESPRESS 10T PUSH PULL	RMB 01	RMB 02	RMB 03	RMB PP01	RMB PP02	RMB 06	RMB 09 & RMB PP03
GYPESPRESS 10T CONNECT	RMB 01	RMB 02	RMB 03	RMB PP01	RMB PP02	RMB 06	RMB 09 & RMB PP03

RMB 01 - BMW 054240

RMB 02 - Jaguar / Land Rover 054271

RMB 03 - VW Group 054257

RMB 04 - Mercedes-Benz 054264

RMB 05 - Ford 055872

RMB 06 - Ferrari 059009

RMB 07 - Mercedes-Benz 064454

RMB 09 - Tesla 059931

RMB PP01 - Mercedes-Benz 058378

RMB PP02 - Ford 058835

RMB PP03 - Tesla 059092

Included XT31-60 - 60 mm extension for HR3 (use with E7, E12) 057135

Included XT31-60 - 60 mm extension for HR3 (use with E2, E3, E9, E10) 057135



ADAPTATEURS POUR RIVETS AVEUGLES - BLIND RIVET ADAPTERS

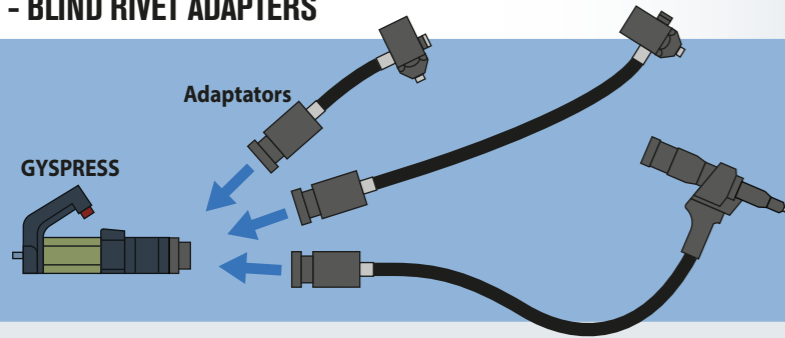

Compatibility	20 kN	24 kN	50 kN
GYSPRESS 8T	✓	✓ (20 kN)	✓ (40 kN)
GYSPRESS 10T	—	✓ (24 kN)	✓ (50 kN)
GYSPRESS 8T PUSH PULL	✓	✓ (20 kN)	✓ (40 kN)
GYSPRESS 10T PUSH PULL	—	✓ (24 kN)	✓ (50 kN)
GYSPRESS 10T CONNECT	—	✓ (24 kN)	✓ (50 kN)

ADAPTATEUR 20 & 24 kN POUR RIVETS AVEUGLES - Blind rivet adapter 20 & 24 kN - Blindnietadapter 20/24 kN



20 kN 150 mm
1.5 kg
059214

Pour rivets POP - For BLIND rivets - Für Blindniet
Acier / Steel : Ø 4.0 → 6.4
Alu: Ø 4.0 → 7.8

HIGH ACCESSIBILITY



SPECIFIC STORAGE

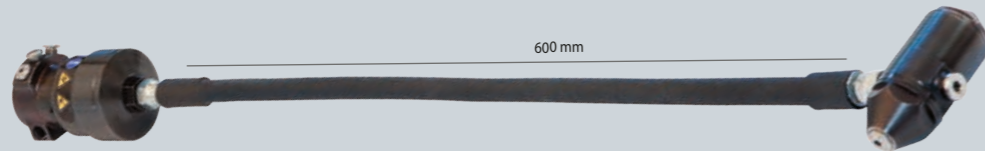
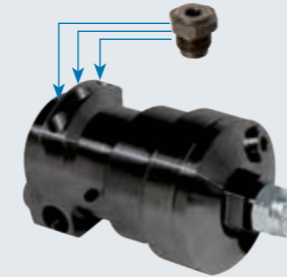

20 kN 600 mm
061576



24 kN 600 mm
063822

INCLUDED (20 kN & 24 kN)

for standard rivets :

- Ø 3.2 x 1 059221
- Ø 3.6 x 1 059238
- Ø 4.0 x 1 059245
- Ø 4.5 x 1 059252



OPTION

Buse pour extraction de rivets RAP Ø4
- Extraction nozzle for Ø4 SPR rivets
064683

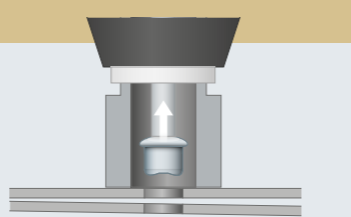
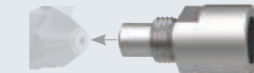

ADAPTATEUR 50 kN POUR RIVETS AVEUGLES - Blind rivet adapter 50 kN - Blindnietadapter 50 kN



50 kN 1 m
064867
4.0 kg

Réglage de la course de traction - Stroke adjustment
0 → 25 mm

Pour rivets POP - For BLIND rivets - Für Blindniet

Acier / Steel : Ø 4.0 → 6.4
Alu: Ø 4.0 → 7.8

INCLUDED

Kit Standard



+ Complete kit 065987



OPTIONS

Buse pour extraction de rivets - Extraction nose-piece
066151



Acier / Steel : Ø 4.0 → 6.4
Alu: Ø 4.0 → 7.8

Extension 160 mm - 160 mm extension - Verlängerung 160 mm
066144

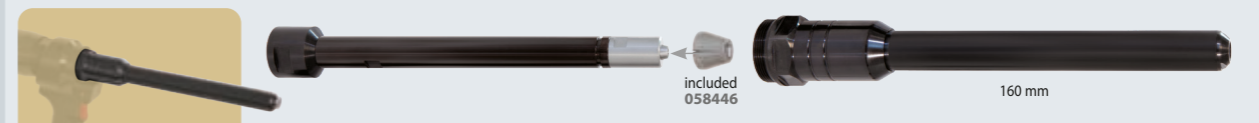

Ø 8.0 → 9.8

Kit Rivets Ø8.0/9.8mm - Ø8.0/9.8mm noze-piece kit - Mundstückkit 8,0/9,8 mm
066045



M5 → M14
M5 → M8

Kit 6 tirants pour pose d'écrous à sertir - Blind rivet nut pulling adapter kit - Blindnietmuttern-Kit
066076



M5	066083
M6	066090
M8	066106
M10	066113
M12	066120
M14	066137

PERFECT COMBO WITH ARC PULL SPÉCIAL ARRACHAGE DE RIVETS - Special tearing rivets - Spezial-Zugnieten

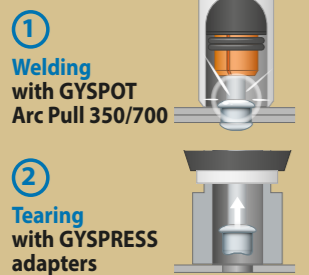

1 Welding with GYSPOT Arc Pull 350/700

2 Tearing with GYSPRESS adaptors



ARC PULL RIVET BOX
for GYSPOT ARC PULL 350
064584

Tige inox - Stainless steel nail Ø 4 x 50 mm x 100 064607	Canon pour pose de tige inox - Barrel for stainless steel nail welding x 1 059634	Support porte-goujon - Mandrel support x 1 059641	Buse + patin pour pistolet Arc Pull - Nozzle + pad for Arc Pull gun x 1 059641	Mandrin M4 - Mandrel M4 x 2 049000	Canon long - Long barrel x 1 067721
x 100	x 1	x 1	x 1	x 2	x 1

BOÎTE CONSOMMABLES POUR ADAPTATEUR 50kN - Consumables box for 50kN adapter - Zubehörbox für 50 kN Adapter



066168

Écrous à sertir - Blind rivet nuts	M5	M6	M8	M10	M12	M14
mm	0.5 → 3.0	0.5 → 3.0	0.5 → 3.0	1.0 → 3.5	1.0 → 4.0	4.5 → 6.0
x 50	066175	066182	066199	066205	066212	066229

Goujons à sertir - Blind rivet bolts	M5	M6	M8
mm	22.5 → 27	24 → 28.5	23.5 → 28
mm	0.5 → 3.0	0.5 → 3.0	0.5 → 3.0
x 50	066236	066243	066250

Rivets aveugles - Blind rivets	Ø 6.4	Ø 9.8
mm	2.8 → 4.8	3.0 → 14.0
x 50	066267	066274

+ plaque de démonstration - demo metal sheet

+ x 10 x 10 x 10 x 10 x 10 x 5 + x 10 x 10 x 10 + x 10 x 10



GYPRESS COMPLETE PACKS



GYPRESS 10T

pack 1 - GYPRESS 10T 066441	063303				HR210 063327	HR310 063334			
	Accessories	Standard 8T/10T 053694	6 x 50 rivets 048706	HR110 063310					
pack 2 - GYPRESS 10T 066458	063303				HR210 063327	HR310 063334	50kN adapter 064867	Pulling adapter kit 066076	
	Accessories	Standard 8T/10T 053694	6 x 50 rivets 048706	HR110 063310					
pack 3 - GYPRESS 10T 064744	063303				HR210 063327	HR310 063334			Trolley+support 055391
	Accessories	Standard 8T/10T 053694	6 x 50 rivets 048706	HR110 063310					

GYPRESS 8T PUSH PULL

pack GYPRESS 8T PUSH PULL 058682	056893				HR2 053878	PP HR3 058903			Trolley+support 055391
	Accessories	Standard 8T/10T PP 058361	6 x 50 rivets 048706	HR15 054219					

GYPRESS 10T PUSH PULL

pack 1 - GYPRESS 10T PUSH PULL 066465	063853				HR210 063327	HR310 063334			
	Accessories	Standard 8T/10T PP 058361	6 x 50 rivets 048706	HR110 063310					
pack 2 - GYPRESS 10T PUSH PULL 066472	056893				HR210 063327	HR310 063334	50kN adapter 064867	Pulling adapter kit 066076	
	Accessories	Standard 8T/10T PP 058361	6 x 50 rivets 048706	HR110 063310					
pack 3 - GYPRESS 10T PUSH PULL 065789	056893				HR210 063327	HR310 063334			Trolley+support 055391
	Accessories	Standard 8T/10T PP 058361	6 x 50 rivets 048706	HR110 063310					



RIVETEUSE HYDRO-PNEUMATIQUE - Hydro-pneumatic tool for blind rivets - Hydro-pneum. Blindnietgerät

HR9
Pour rivets POP - For BLIND rivets - Für Blindniet
Acier / Steel Ø 3.2/4.0/4.8
Alu Ø 3.2/4.0/4.8



max 9 000 N
057234
Made in Taiwan

RIVETEUSE HYDRO-PNEUMATIQUE - Hydro-pneumatic tool for blind rivets - Hydro-pneum. Blindnietgerät

HR14
Pour rivets POP - For BLIND rivets - Für Blindniet
Acier / Steel Ø 4.0/4.8/6.4
Alu Ø 4.0/4.8/6.4



max 14 000 N
057241
Made in Taiwan

RIVETEUSE SUR BATTERIE - Cordless riveter - Akku-Blindnietgerät

TWO ER20 064461
Pour rivets POP - For BLIND rivets - Für Blindniet
Ø 4.0/4.8/5.0/6.0/6.4



max 20 000 N (6 bar)
10-20 V universal fast charger (30 min)
2.0 kg
20V/2Ah Li-ion battery

RIVETEUSE MANUELLE - Manual tool for blind rivets - Manueller Blindnietgerät

Pour rivets POP - For BLIND rivets - Für Blindniet
Acier / Steel Ø 3.2/4.0/4.8/6./6.4
Alu Ø 3.2/4.0/4.8/6./6.4



061323
Made in Taiwan

SERTISSEUSE HYDRO-PNEUMATIQUE RIV 998 - Hydro-pneumatic tool for rivet nuts - Hydro-pneum. Blindnietmuttergerät

RIV 998
Ecrous à sertir - Sealing nuts - Blindnietmuttern



Pour la pose d'écrous à sertir M4 à M12
max 19 000 N (6 bar)
livré avec accessoires pour écrous à sertir M4 à M12
055414



RIVETEUSE HYDRO-PNEUMATIQUE - Hydro-pneumatic tool for blind rivets - Hydro-pneum. Blindnietgerät

HR21
Pour rivets POP - For BLIND rivets - Für Blindniet
Ø 4.0 → 7.8



max 21 000 N (6 bar)
055407



- included (x3) 058446
- For standard rivets Ø 4.0 51508
- For Magnarive rivets Ø 4.5 51507
- Option HR21 extension 100 mm 063105





AUTOGYS

GMAW MIG/MAG SYNERGIC



CARMIG

15 \blacktriangle 200 A
400V • 3~

with accessories 032132

NEW DESIGN

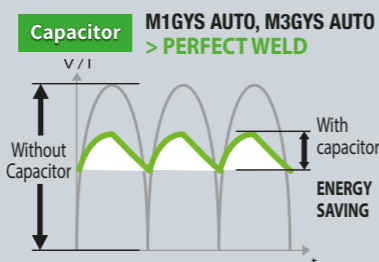

Capacitor M1GYS AUTO, M3GYS AUTO > PERFECT WELD

Without Capacitor
With capacitor
ENERGY SAVING

M1 GYS AUTO

15 \blacktriangle 160 A Capacitor

230V • 1~
with accessories 032903

208/240V • 1~
with accessories 032088

T1 GYS AUTO

15 \blacktriangle 200 A

400V • 3~
with accessories 032910

T1 GYS AUTO DV

15 \blacktriangle 200 A

230V • 3~ / 400V • 3~
with accessories 032927

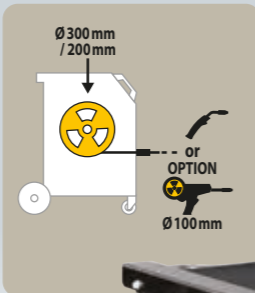

NEW DESIGN



SYNERGIC - EASY TO USE
Réglage automatique de la vitesse \ Auto adaptative wire speed
Automatische Einstellung der Drahtgeschwindigkeit

100% READY

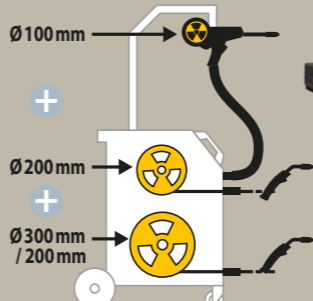

Acier/Steel, 3 m
063754

Échantillons de tôles - Sheets set

Acier standard/
Standard steel
0,8 (x65) + 1 (x55)
+ 1,5 (x35) + 2 (x25)
+ Alu
1 (x45) + 1,5 (x30)
+ 2 (x20)
055841

M3 GYS AUTO

15 \blacktriangle 160 A Capacitor

230V • 1~
with accessories: 032880

T3 GYS AUTO

15 \blacktriangle 200 A

400V • 3~
with accessories: 032958

with accessories: 032941

T3 GYS AUTO DV

15 \blacktriangle 200 A

230V • 3~ / 400V • 3~
with accessories: 032972

NEW DESIGN



2 x 4m³
(20L)

ACCESSORIES BOX

câble secteur - mains cable
6m



OPTIONS

Torche motorisée Spool Gun
- Spool Gun Torch - Spool Gun Brenner



041486

Ø 100
Ideal for
- Acier / Steel / Stahl
- Inox / Stainless steel
- Alu

included 045699

SPOOL GUN + Support
for M3 & T3 GYS AUTO

038554



15L/min (FR) 041998
(UK) 040274
(NL) 040267
(IT) 038691

OPTIMAPRO 30L/min (FR) 043619
(UK) 043626
(DE) 043633
(NL) 043640

30L/min (FR) 041622
(UK) 041646
(DE) 041219
(NL) 041615
(IT) 038707

041332



T3GYS & M3GYS :
Housse de protection
- Protection cover
- Schutzhaube
052260

041806



MB 15 (150A)
041226

x3
x5
x5 (M6-Ø0,6)
x5 (M6-Ø0,8)
x5 (Alu - M6-Ø0,8)

Protection gas
Argon+CO₂(Steel, Inox)
Argon (ALU/CuSi3/CuAl8)
CO₂PUR (Steel)

MADE IN FRANCE	MADE IN CHINA	NORM. 60974/1	50/60 Hz	A	min → max	Reg	100 (spoolgun)	200	300	Electronic Control	EN60974-1 (40°C)			cm/kg	Protected & compatible power generator (+/-15%)		
											IA (60%)	X% (I2 max)	Ø mm				
■	■	■	400V 3~	10	15 → 200	7	-	■	■	electronic	110	150A@25%	0,6+1	0,6/0,8	0,8	47x77x79 / 50	5 kVA
■	■	■	230V 1~ 208/240V 1~	16	15 → 160	6	option	■	■	400V	90	140A@15%	0,6+1	0,6/0,8	0,8	47x77x79 / 46	4,5 kVA
■	■	■	400V 3~	10	15 → 200	7	option	■	■	400V	110	150A@25%	0,6+1	0,6/0,8	0,8	47x77x79 / 52	5.2 kVA
■	■	■	230V 3~ / 400V 3~	10	15 → 200	7	option	■	■	400V	110	150A@25%	0,6+1	0,6/0,8	0,8	47x77x79 / 52	5.2 kVA
■	■	■	230V 1~ 208/240V 1~	16	15 → 160	6	■	■	■	400V	90	140A@15%	0,6+1	0,6/0,8 0,8/1,0	2 x 0,8	60x90x90 / 58	4,5 kVA
■	■	■	400V 3~	10	15 → 200	7	■	■	■	400V	110	150A@25%	0,6+1	0,6/0,8 0,8/1,0	2 x 0,8	60x90x90 / 75	5.2 kVA
■	■	■	230V 3~ / 400V 3~	10	15 → 200	7	■	■	■	400V	110	150A@25%	0,6+1	0,6/0,8 0,8/1,0	2 x 0,8	60x90x90 / 75	5.2 kVA



GMAW MIG/MAG INVERTER • SYNERGIC

4 in 1

GAS	NO GAS
MMA	TIG

1 MIG / MANUAL
Enter your parameters

Adjust Spot & Delay

2 MIG / SYNERGIC
Easy to use

Select:

- 1. material
- 2. Ø wire
- 3. position
- 4. thickness

Adjust arc length

Fe	CrNi
AlMg5	CuSi3
AlSi5	AlSi12
CuAl8	F.C.

3 MMA

HotStart ArcForce

4 TIG lift

Post Gas Downslope



MULTEPEARL 210-2

200 A ⚡ ⚡ ⚡ ⚡ ⚡ ⚡ ⚡ ⚡ ⚡ ⚡

P400 PFC FV SR

GAS	NO GAS	MMA	TIG
-----	--------	-----	-----

3 m 2.5 m, 16 mm² 2 m, 16 mm²

065093

MULTEPEARL 210-4 XL

200 A ⚡ ⚡ ⚡ ⚡ ⚡ ⚡ ⚡ ⚡ ⚡ ⚡

P400 PFC FV SR

GAS	NO GAS	MMA	TIG
-----	--------	-----	-----

3 m 2.5 m, 16 mm² 2 m, 16 mm²

065109

MULTEPEARL 211-4

200 A ⚡ ⚡ ⚡ ⚡ ⚡ ⚡ ⚡ ⚡ ⚡ ⚡

P400 PFC FV SR

GAS	NO GAS	MMA	TIG
-----	--------	-----	-----

3 m 2.5 m, 16 mm² 2 m, 16 mm²

065116

PFC POWER FACTOR CORRECTION
185 V ↔ 265 V

FV FLEXIBLE VOLTAGE
85 V ↔ 265 V

SR SECONDARY REGULATION
I (A) STABLE

NO GAS

KIT SOUDAGE NO GAZ Ø 0.9
- No Gas Welding Kit Ø 0.9
- Schweißset Fülldraht

TYPE A
MultiPearl 200-2 only
041240

TIG torch kit SR17 V (valve)
4 m
10/25 mm²
044425

TIG torch kit SR17 DB
4 m
046108

EURO

MADE IN FRANCE EN60974-1	50/60 Hz	I ₁ A	I ₂ MMA A	I ₂ TIG A	min → max	EN60974-1 (40°C)	U ₀ (V)	MIG			GAS	NO GAS	MMA	TYPE	cm	kg	7.5 kW		
								Electronic Control	max	Ø mm									
MULTIPEARL 210-2	110V 1~	32	20 → 130	20 → 180	20 → 150	100	150 A @ 22%	75	15	■	■	—	0.6 → 1.0	0.9 → 1.2	1.6 → 3.2	A	25 x 45 x 35	16	7.5 kW
	230V 1~	13	20 → 200	20 → 200	20 → 200	130	200 A @ 20%	76	15	■	■	—	0.6 → 1.0	0.9 → 1.2	1.6 → 5.0	A	25 x 45 x 35	16	7.5 kW
MULTIPEARL 210-4 XL	110V 1~	32	20 → 130	20 → 180	20 → 150	100	150 A @ 22%	75	15	■	■	■	0.6 → 1.0	0.9 → 1.2	1.6 → 3.2	B	25 x 55 x 44	20	7.5 kW
	230V 1~	13	20 → 200	20 → 200	20 → 200	130	200 A @ 20%	76	15	■	■	■	0.6 → 1.0	0.9 → 1.2	1.6 → 5.0	B	25 x 55 x 44	20	7.5 kW
MULTIPEARL 211-4	110V 1~	32	20 → 130	20 → 180	20 → 150	100	150 A @ 22%	75	15	■	■	■	0.6 → 1.0	0.9 → 1.2	1.6 → 3.2	B	41 x 73 x 77	37	7.5 kW
	230V 1~	13	20 → 200	20 → 200	20 → 200	130	200 A @ 20%	76	15	■	■	■	0.6 → 1.0	0.9 → 1.2	1.6 → 5.0	B	41 x 73 x 77	37	7.5 kW



AUTOPULSE

GMAW MIG/MAG INVERTER DOUBLE PULSE

Latest generation colour screen 5" / 800 x 480 (WVGA)



3 WELDING MODES :

1 EASY



2 EXPERT

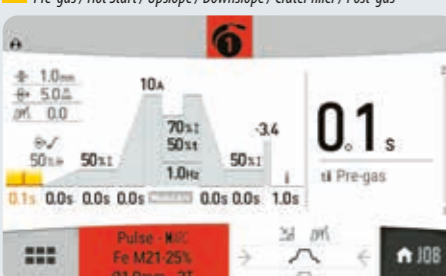

3 ADVANCED

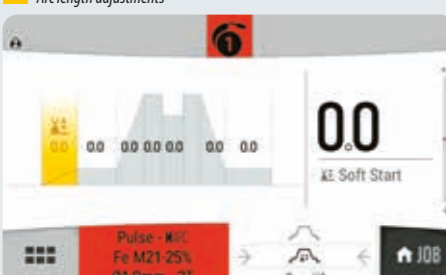

Up to 500 JOBS can be saved



Traceability **NEW**



Portability **NEW**



PROCESSES

- Dynamic standard
- Pulse
- Pulse in Pulse
- Manual
- Cold Pulse**

FULLY DIGITAL

- 4 MICROPROCESSORS
- DSP**

65+ SYNERGIES

- STEEL
- Cu Si 3 / Cu Al 8**
- ALU

EASY USB UPDATE

USB key 16 Gb 062344

	AUTOPULSE 220-M1	AUTOPULSE 220-M3	AUTOPULSE 220-M3 208-240V
1	1 $\varnothing 200 \rightarrow 300$ mm PP	1 $\varnothing 200$ mm	1 $\varnothing 200$ mm PP
2	- - - -	2 $\varnothing 200$ mm PP	2 $\varnothing 200$ mm -
3	- - - -	3 $\varnothing 200$ mm -	3 $\varnothing 200$ mm -



BODYSHOP SPECIFIC
COLD PULSE
CuSi3 \varnothing 0.8 / 1



AUTOPULSE 220-M1

15 220 A 230V 1~
PFC
065024

AUTOPULSE 220-M3

15 220 A 230V 1~
PFC
036703

AUTOPULSE 220-M3 208-240V

15 220 A 208>240V 1~
PFC
062481

PUSH PULL TORCH 24V

details p. 72

MB 15
4m
044111

MB 25
4m
046283



SPOOLGUN TORCH

details p. 72

MB 15 / MB 25 (250 A)
037458

Ideal Alu
 \varnothing 0,8

- x5 (M6-0.8)
- x5 (M6-0.1.0)
- x5 (Alu-M6-0.8)
- x5 (M6-0.8)
- x5 (M6-0.1.0)
- x5 (Alu-M6-0.1.0)
- x5 (Alu-M6-0.1.2)

Motor inside

details p. 72

Ideal Alu
 \varnothing 0,8

4m 041486



Débimètre de bout de torche

053939

Housse de protection - Protection cover - Schutzhaube

052260



MADE IN FRANCE CE NORM. EN60974-1	50 / 60 Hz	A	\varnothing mm	min \rightarrow max	SPOOLGUN	PUSH/PULL	200 300	Cooling system	EQUIPEMENT D'ORIGINE Original equipment Originalausstattung Equipamiento de fabrica	EN60974-1 (40°C)			Protected & compatible power generator (+/-15%)
										IA (60%)	X% (I2 max)	cm / kg	
AUTOPULSE 220-M1	230 V · 1~	16	0.6 \rightarrow 1.2	15 \rightarrow 220	-	OPTION	■ ■	Air	ALU : Type B 1.0 / 1.2	150	220 A @ 20%	88x93x63 / 69	10 kVA
AUTOPULSE 220-M3	230 V · 1~	16	0.6 \rightarrow 1.2	15 \rightarrow 220	OPTION	OPTION	■ -	Air	ACIER : Type B 0.8 / 1.0 mm ALU : Type B 1.0 / 1.2	150	220 A @ 20%	88x93x63 / 69	10 kVA
AUTOPULSE 220-M3 208-240V	208 > 240 V · 1~	16	0.6 \rightarrow 1.2	15 \rightarrow 220	-	OPTION	■ -	Air	ACIER : Type B 0.8 / 1.0 mm ALU : Type B 1.0 / 1.2	150	220 A @ 20%	88x93x63 / 69	10 kVA

GMAW MIG/MAG INVERTER DOUBLE PULSE



BODYSHOP SPECIFIC
COLD PULSE
CuSi3 Ø 0.8/1

PFC POWER FACTOR CORRECTION

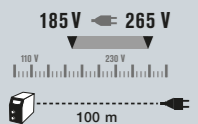

AUTOPULSE 320-T3

15 320 A 400V 3~

PFC

036710

AUTOPULSE 320-T3 208-240V

15 320 A 208>240V 3~

PFC

036970

	50/60 Hz	A	Ø mm	min→max	SPOOLGUN	PUSH/PULL	200	Cooling system	ELECTRONIC CONTROL	IA (60%)	X% (I2 max)	cm / kg	Protected & compatible power generator (+/-15%)
AUTOPULSE 320-T3	400 V - 3~	16	0.8+1.2	15+320	OPTION	OPTION	■	Air	ACIER : Type C 0.8 / 1.0 mm ALU : Type C 1.0 / 1.2	260	320 A @ 35%	90x92,5x63 / 82.5	16 kVA
AUTOPULSE 320-T3 208-240V	208-240 V - 3~	25	0.8+1.2	15+320	—	OPTION	■	Air	ACIER : Type C 0.8 / 1.0 mm ALU : Type C 1.0 / 1.2	260	320 A @ 35%	90x92,5x63 / 82.5	16 kVA

	AUTOPULSE 320-T3				AUTOPULSE 320-T3 208-240V			
1	1	Ø 200 mm	PP	PP	1	Ø 200 mm	PP	PP
2	2	Ø 200 mm	PP	PP	2	Ø 200 mm	PP	PP
3	3	Ø 200 mm	PP	PP	3	Ø 200 mm	PP	PP



PUSH PULL TORCH 24 V

details p. 72



MB 15
4m
044111

MB 25
4m
046283



SPOOLGUN TORCH

details p. 72

Ideal Alu
Ø 0,8

4m 041486

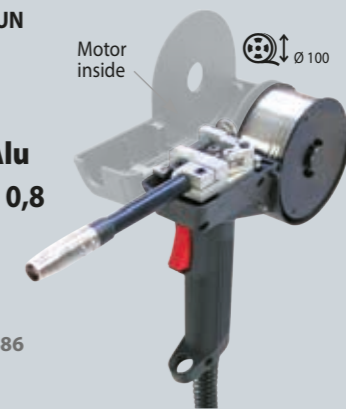

Débitmètre de bout de torche
053939

Housse de protection
- Protection cover
- Schutzhaube

052260

AUTOPULSE ~1ph 220A CONFIGURATIONS

AUTOPULSE 220-M1						
065024 NEW		4 m, 35 mm² 043817	—	—		Alu 250 A, 3 m, air Ø 1.2
AUTOPULSE 220-M3 230 V						
036703		4 m, 35 mm² 043817				CuSi 150 A, 3 m, air Ø 1.0 Steel 150 A, 3 m, air Ø 0.8 Alu 250 A, 3 m, air Ø 1.2
AUTOPULSE 220-M3 208-240 V						
062481 NEW		4 m, 35 mm² 043817				CuSi 150 A, 3 m, air Ø 1.0 Steel 150 A, 3 m, air Ø 0.8 Alu 250 A, 3 m, air Ø 1.2

AUTOPULSE ~3ph 320A CONFIGURATIONS

AUTOPULSE 320-T3 400V						
036710		4 m, 35 mm² 043817		—	—	—
AUTOPULSE 320-T3 208-240V						
PACK 1 059184		4 m, 35 mm² 043817				
PACK 2 059191		4 m, 35 mm² 043817				
AUTOPULSE 320-T3 400V						
036970 NEW		4 m, 35 mm² 043817		—	—	—
AUTOPULSE 320-T3 208-240V						
PACK 1 065826 NEW		4 m, 35 mm² 043817				
PACK 2 065833 NEW		4 m, 35 mm² 043817				

HELMETS

TRUECOLOR TECHNOLOGY



Classic spectrum



Truecolor spectrum

- Battery charger
037472
☎: 028869
- Battery included
037465
- x1
038424
- x5
038417



Filtration
class EN 12941 :
TH2 P R SL
Air 165 / 200 / 220 L/min
Battery included

OPTION Filter TH3
065734



GYSMATIC 9/13 G AIR
TRUECOLOR
065727

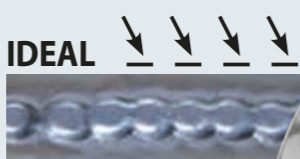

IDEAL



LCD GYSMATIC 9/13 G
TRUECOLOR
043909

◀ 100 x 60 mm ☐ → ■ 0.08 ms



LCD FIREMAN 9-13
TRUECOLOR
062269

◀ 100 x 49 mm ☐ → ■ 0.15 ms

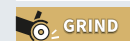

ZEUS 5-9/9-13 G
INDIAN
038332



ERGOTECH 5-9/9-13
SILVER
044173



ZEUS 5-9/9-13 G
FIRE TRUECOLOR
044098



ERGOTECH 5-9/9-13
BLACK
045477



ZEUS 5-9/9-13 G
COSMIC
044104



ERGOTECH 5-9/9-13
DREAM
037212

◀ 100 x 67 mm ☐ → ■ 0.12 ms



◀ 100 x 67 mm ☐ → ■ 0.12 ms



☒ × 4
4 SENSORS
HIGH SENSITIVITY



GRIND
MODE



GYSMATIC XL
TRUECOLOR
037908

◀ 100 x 60 mm ☐ → ■ 0.08 ms

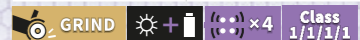

ALIEN XXL
TRUECOLOR
037229

◀ 100 x 90 mm ☐ → ■ 0.15 ms



EXPERT DIN 9/13 Adjustable

DIN 5/13 Adjustable

EXPERT DIN 5/13 Adjustable

OPTIONS

Sac pour masque de soudage
- Carry bag for helmet welding



043299



066656



Bandeau anti-transpiration
- Antiperspirant - headband
043466
x2



Loupe
- Magnifying glass
for Zeus, Ergotech
& Alien True Color
x1

zoom x2
042780

zoom x3
064140

VERRES
- Lenses
- Schutzgläser

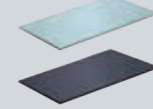

					TRUECOLOR	☐ → ■	☐ → ■ HF	☐ → ■ DELAY								MASK BRAND		
226 x 106 (x5)	045781	103.6 x 54 (x5)	040809	LCD FIREMAN 9-13 TRUECOLOR	4-9>13	■	0.15 ms	—	0.15 > 0.8 s	1/1/1/2	2	100x49 mm	■	—	☼	Multi	490 g	Gys
114x133 (x10)	043893	G: 106 x 66 (x10)	043886	LCD GYSMATIC 9/13 G TRUECOLOR	4-9>13	■	0.08 ms	✓	0.10 > 0.90 s	1/1/1/2	4 HIGH SENSITIVITY	XL: 100x60 mm	■	✓	☼ + 2 (CR 2450)	Simple	580 g	Gys
114 x 133 (x10)	043893	103.7 x 69.5 (x5)	043695	ZEUS	4-5>9/9>13	■	0.12 ms	—	0.15 > 0.8 s	1/1/1/2	4	XL: 100x67 mm	■	✓	☼ + 2 (CR 2450)	Multi	520 g	Gys
114 x 133 (x10)	043893	103.7 x 69.5 (x5)	043695	ERGOTECH	4-5>9/9>13	■	0.12 ms	—	0.15 > 0.8 s	1/1/1/2	4 HIGH SENSITIVITY	XL: 100x67 mm	■	✓	☼ + 2 (CR 2450)	Multi	560 g	Gys
110 x 90 (x5)	040816	106 x 66 (x10)	043886	GYSMATIC XL TRUECOLOR	4-5>9/9>13	■	0.08 ms	✓	0.1 > 0.9 s	1/1/1/1	4 HIGH SENSITIVITY	XL: 100x60 mm	■	✓	☼ + 2 (CR 2450)	Comfort	540 g	Gys
114 x 133 (x10)	043893	104 x 96 (x5)	043596	ALIEN XXL TRUECOLOR	4-5>9/9>13	■	0.15 ms	✓	0.15 > 0.8 s	1/1/1/2	4 HIGH SENSITIVITY	XXL: 100x90 mm	■	—	☼ + 2 (CR 2032)	Multi	560 g	Gys

Battery charger
037472
☎ : 028869

Battery included
037465

x1
038424

x5
038417

GYSMATIC 5/13 AIR XXL TRUECOLOR
047846
☎ : 028852

OPTION
Filter TH3
065734

Filtration class
EN 12941 : TH2 P R SL
Air 165 / 200 / 220 L/min
Battery included

IDEAL

	APOLLO 5-9/9-13G	PANORAMIC 3XL
PANORAMIC	Fixed DIN 5	DIN 3 > 10
	DIN 3 > 5/13 Adjustable	DIN 3 > 4/12 Adjustable
	Fixed DIN 5	DIN 3 > 10

APOLLO 5-9/9-13 G TRUECOLOR
037809

100 x 67 mm 0.12 ms

GRIND + 4 PANORAMIC

PANORAMIC DIN 5/13 Adjustable

DIGITAL

MEMORY & REGULATIONS ELECTRONIC

memory saving x3

COMFORT PRO

GYSMATIC 5/13 AIR XXL TRUECOLOR
047846
☎ : 028852

GYSMATIC 5/13 AIR XXL TRUECOLOR
037236

100 x 83 mm 0.10 ms

GRIND + 4 Class 1/1/1/1 DIGITAL

DIGITAL DIN 5/13 Adjustable

PANORAMIC 3XL TRUECOLOR
037281

114 x 85 mm 0.15 ms

GRIND + 4 Class 1/1/1/1 PANORAMIC

PANORAMIC DIN 4/12 Adjustable

TORCHES ASPIRANTES - Fume Extraction Torches

BINZEL

Acier/Inox - Steel/Stainless steel - Stahl/Edelstahl

AIR

	150 A	250 A
original equipment	M6	M6
Ø	Ø0.8	Ø1.0
X % 40°C - ArCO ₂	150A - 60%	200A - 60%
GRIP	GRIP	GRIP
L	3m	3m
Ref.	043251	040540

ASPIRATEUR DE FUMÉE - Fume Extraction System

BINZEL

- 230V / 1 ~, 1100 W
- 200 m³/h max
- 190 mbar max
- 26 kg, 390 x 210 x 500 mm
- 71 db
- Système de nettoyage automatique du filtre - Filter auto cleaning system - Automatische Filterabreinigung

Automatic ON/OFF
043237
Manual
043244

= 100 m³/h

ASPIRATEURS DE FUMÉE - Fume Extraction Systems - Rauchgasabsauggerät

UNI 2.0 RE

- 400V / 3 ~ / 50 Hz
- 1100 W
- 1300 m³/h max
- 3-4h/day
- arm 3 m
- no plug
- 100 kg
- extraction 0.5 m/s

061545

Included: Pré-filtre (treillis aluminium) - Pre-filter (aluminium mesh) Class G3 EN 779

Filter - Filter Class H12 EN 779 Filtration > 99 % 046467

Option Flexible d'extraction 10 m Ø 150 mm 062139

EVO 2.1 RE

- 230V / 1 ~ / 50 Hz - 32A
- 1100 W
- 1200 m³/h max
- occasional
- arm 3 m
- included
- 85 kg

061552

Breveté - Patented

Included: Pré-filtre (treillis aluminium) - Pre-filter (aluminium mesh) Class G3 EN 779

Filter - Filter Class H12 EN 779 Filtration > 99 % 046467

Option Flexible d'extraction 10 m Ø 150 mm 062139

PROFI MASTER

- 1100 W
- 1100 m³/h
- 72 dB (A)
- arm 3m
- 104 Kg (with arm)
- 400V / 3 ~ / 50 Hz

067783

NEW

Pre-filter x1 067820

Main filter x1 067844

SMART MASTER

- 1100 W
- 950 m³/h
- 72 dB (A)
- occasional (1 sel N)
- arm 3m
- 81 kg (with arm)

067769

NEW

Pre-filter x10 067790

Pre-filter x10 067806

Main filter x1 067813

VERRES - Lenses - Schutzgläser				TRUE COLOR													MASK BRAND
114 x 133 (x10)	043893	106 x 89,5 (x10)	046825	GYSMATIC XXL & 5/13 AIR XXL TRUECOLOR XXL	4-5>9/9>13	0.10 ms	✓	0.1 > 0.9 s	1/1/1/1	4 HIGH SENSITIVITY	XXL : 100x83 mm	✓	☀ +2 (CR 2450)	Comfort Pro	680 g	Gys	
114 x 133 (x10)	043893	103.7 x 69.5 (x5)	043695	APOLLO 5-9/9-13 G	4-5>9/9>13 + 2x:5	0.15 ms	—	0.15 > 0.8 s	1/1/1/2	4 HIGH SENSITIVITY	XXL : 100x67 + 2x103.7x69.5 mm	✓	☀ +2 (CR 2450)	Multi	580 g	Gys	
390 x 150 (x3)	037311	special kit (x5)	037304	PANORAMIC 3XL TRUECOLOR	3-4>8/8>12 + 2x:3>10	0.15 ms	✓	0.15 > 0.8 s	1/1/1/1	4 HIGH SENSITIVITY	114x85 + 2x(68x80) mm	—	☀ +2 (CR 2450)	Multi	610 g	Gys	



INDUCTION HEATING

CAR BODY

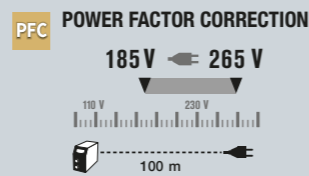

055490

GYSDUCTION AUTO

2400 W 230V • 1~

PFC AIR

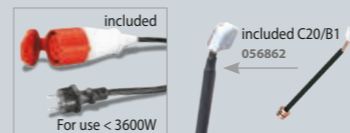

COMBIDUCTION AUTO 50LG

5200 W 230V • 1~

PFC LIQUID

065901



INCLUDED COMBIDUCTION

Décapage - Glass - Entfernen 053373

Protection (x5) + Colle - Stick 053854

Décollage - Decal - Entkleben 053359

Protection (x1) + Colle - Stick 059108

OPTIONS

Inducteur spirale - Spiral inductor - Spiralinduktor 054783

1.2 kW

2.5 m

Débosselage sans peinture - PDR : Paintless Dent Repair - Lackschadenfreies Ausbeulen 054776

Licensed by BETAG innovation

3 m

Spray refroidisseur - Freezer spray

-50 °C 400 ml (x 12) 048898

Adhesive for logo (x10) 051492

	PACKS - GYSDUCTION AUTO							
	PROLINER AUTO 048775	COMPLETE AUTO 053380	COMPLETE AUTO + 056978	MECA AUTO 048812	MECA AUTO + 056961	BODY SHOP AUTO 048799	GLASS AUTO 048805	DENT REPAIR AUTO 054981
1 box	=	=	=	=	=	=	=	=
GYSDUCTION AUTO	✓	✓	✓	✓	✓	✓	✓	✓
Plastic wedges 051294	✓	✓	✓	-	-	✓	✓	-
Burn off inductor 053373	✓	✓	✓	-	-	✓	✓	-
Body inductor 053359	✓	✓	✓	-	-	✓	-	-
Bolt inductor 053366	✓	✓	✓	✓	✓	-	-	-
Remote control 055490	✓	✓	✓	✓	✓	✓	-	-
Universal 800 051331	✓	-	-	-	-	-	-	-
Cable support 052284	✓	-	-	-	-	-	-	-
Dent pulling inductor 054776	-	-	✓	-	-	✓	-	✓
Spiral inductor 054783	-	-	✓	-	✓	-	-	-



EN 60335/1	MADE IN FRANCE	Cable L (m)	A	W	Freq. kHz	Tech. PFC	Liquid Cooling	Inductor	Heating	cm	kg	Protected & compatible power generator (+/-15%)		
													Inductor	Heating
GYSDUCTION AUTO	230V, 1~ , 50/60 Hz	16 mini	2400	35+100	▪		2	2.5	M10 → 1 s	2 mm → 5 s	Ø8 → 10 s	36 x 27 x 22	7.5	3 kW
COMBIDUCTION AUTO 50LG	230V, 1~ , 50/60 Hz	25 mini	5200	30+50	▪	71	8	3	M14 → 1 s	2 mm → 3 s 4 mm → 5 s	Ø10 → 10 s	59 x 88 x 59	72	6 kW



POWERDUCTION

INDUCTION HEATING

MAINTENANCE / MECHANIC / INDUSTRY

PFC POWER FACTOR CORRECTION

185V ↔ 265V

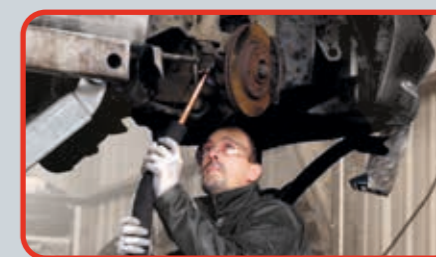
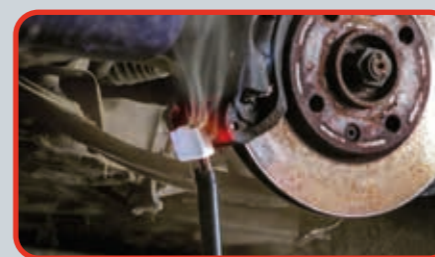

81

POWERDUCTION

INDUCTION HEATING

INCLUDED

Spirale - Coil - Spiralförmiger draht

Ø 18 mm 054806

Ø 24 mm 054790

Ø 30 mm 055469

Fil tressé enroulable - Flexible wrappable wire - Flexibel geflochtener draht

800 mm 054813

Fil droit rigide - Straight rigid wire - Steif gerade draht

800 mm 054868



1 m

POWERDUCTION 10R

1 200 W 230V • 1~

AIR

062504



2 m

POWERDUCTION 37LG

3 700 W 230V • 1~

LIQUID

056992



3 m

POWERDUCTION 39LG

3 700 W 230V • 1~

PFC LIQUID

058583



3 m

POWERDUCTION 50LG

5 200 W 230V • 1~

PFC LIQUID

055599



4 m

POWERDUCTION 110LG

11 000 W 400V • 3~

LIQUID

058590

11 000 W 208-240V • 3~

LIQUID

065246

NEW

OPTION 10R

NEW

Decal - Décollage - Entkleben 066601



OPTION 37LG



Cable support 052284

Chariot - Trolley UNIVERSAL 800 051331



Youtube

EN-60 335/1	MADE IN FRANCE	Cable L (m)	A	W	kHz	INTEGRATED TECHNOLOGY		Liquid Cooling	Cable L (m)		Heating		cm	kg	Protected & compatible power generator (+/-15%)
						P400	PFC		Inductor	Heating	Heating				
POWERDUCTION 10R	230V, 1~, 50/60 Hz	10 mini	1 200	45+80	—	—	—	2	1	M10 → 1 s	2 mm → 5 s	Ø8 → 10 s	23 x 14 x 10	3	1.5 kW
POWERDUCTION 37LG	230V, 1~, 50/60 Hz	16 mini	3 700	15+30	—	—	1.51	2	2	M10 → 1 s	2 mm → 5 s	Ø10 → 15 s	45 x 29 x 25	15	4 kW
POWERDUCTION 39LG	230V, 1~, 50/60 Hz	16 mini	3 700	30+50	■	■	71	2	3	M12 → 1 s	2 mm → 5 s	Ø10 → 15 s	53 x 70 x 37	39.5	4 kW
POWERDUCTION 50LG	230V, 1~, 50/60 Hz	25 mini	5 200	30+50	■	■	71	8	3	M14 → 1 s	2 mm → 3 s 4 mm → 5 s	Ø10 → 10 s	59 x 88 x 59	70	6 kW
POWERDUCTION 110LG 400V	400V, 3~, 50/60 Hz	16 mini	11 000	25+40	—	—	71	5	4	M18 → 1 s	2 mm → 2 s 4 mm → 4 s	Ø10 → 7 s	59 x 88 x 59	80	15 kW
POWERDUCTION 110LG 208-240V	208-240V, 3~, 50/60 Hz	35 mini	11 000	25+40	—	—	71	5	4	M18 → 1 s	2 mm → 2 s 4 mm → 4 s	Ø10 → 7 s	59 x 88 x 59	86	15 kW



POWERDUCTION - ACCESSORIES & CONSUMABLES



6 m

included adapter 32L + L90 064515 + 059788

COMING SOON

POWERDUCTION 160LG
16 000 W 400V • 3~
 LIQUID
 057814

16 000 W 208-240V • 3~
 LIQUID
NEW
 065253

POWERDUCTION 220LG
22 000 W 400V • 3~
 LIQUID
 066861

OPTIONS



Housse de protection - Protection cover - Schutzhaube for POWERDUCTION 160LG 050853



Cooling liquid (not included) 5L 062511 10L 052246

Model	Voltage	Power	Freq.	Liquid Cooling	Cable L (m)	Heating			cm	kg	Protected & compatible power generator (+/-15%)
						Inductor	Inductor	Heating			
POWERDUCTION 160LG 400V	400V, 3~ 50/60 Hz	16 000	25+40	301	6	M20 → 1s	2 mm → 2s 4 mm → 4s	Ø10 → 5s	70 x 118 x 60	120	22 kW
POWERDUCTION 160LG 208-240V	208-240V, 3~ 50/60 Hz	16 000	25+40	301	6	M20 → 1s	2 mm → 2s 4 mm → 4s	Ø10 → 5s	70 x 118 x 60	130	22 kW
POWERDUCTION 220LG	400V, 3~ 50/60 Hz	22 000	25+40	301	6	N/A	N/A	N/A	70 x 118 x 60	125	22 kW

t° POWER HEAT CONTROLLER



t° CONTROL
80>350°C

NEW

POWER HEAT CONTROLLER 061644

Included T° sensors thermocouple type K x2

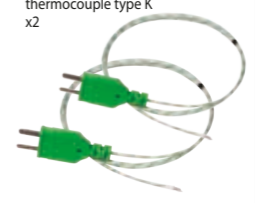

Youtube

OPTIONS



Pyrometer IR for inductor L90
1.1 m 064119



INDUCTEURS - Inductors

Model	SMALL (Ø16)				LARGE (Ø32)								
	S90	S70	S180	S20/B1 (20°)	S180/B1	S180/B2	S180/B3	S180/B3W	L90 (90°)	L70 (70°)	L180	L180/Spiral	L20/B4
37 LG	✓*			✓				✓					
39 & 50 LG				with adapter 28S						with adapter 28L			
110 & 160 LG				with adapter 32S					with adapter 32L*		with adapter 32L		
220 LG				with adapter 32S						with adapter 32L			with adapter 32L*

Model	28S		32S		28L		32L	
	M28 Ø16	064485	M32 Ø16	064508	M28 Ø32	064492	M32 Ø32	064515
37 LG								
39 & 50 LG			✓					✓
110 & 160 LG			✓					✓
220 LG			✓					✓

COMPLETE (Ø28)

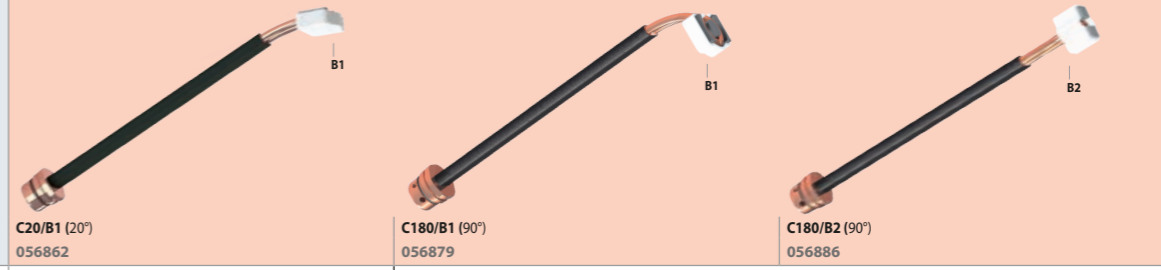

Model	Part	Code
39 & 50 LG	C20/B1 (20°)	056862
	C180/B1 (90°)	056879
	C180/B2 (90°)	056886

BOÎTES - Boxes

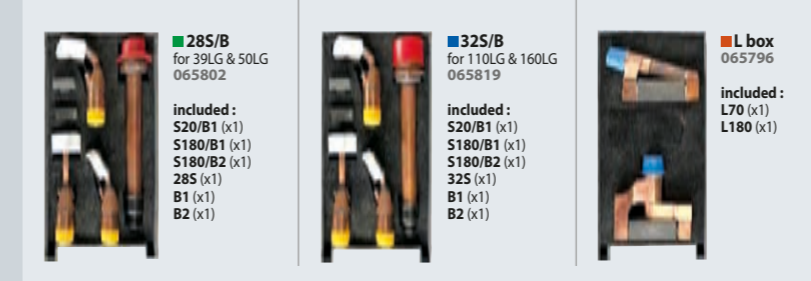

28S/B for 39LG & 50LG 065802
 included: S20/B1 (x1), S180/B1 (x1), S180/B2 (x1), 28S (x1), B1 (x1), B2 (x1)

32S/B for 110LG & 160LG 065819
 included: S20/B1 (x1), S180/B1 (x1), S180/B2 (x1), 32S (x1), B1 (x1), B2 (x1)

L box 065796
 included: L70 (x1), L180 (x1)

FERRITES - Ferrites - Ferritaufsatz

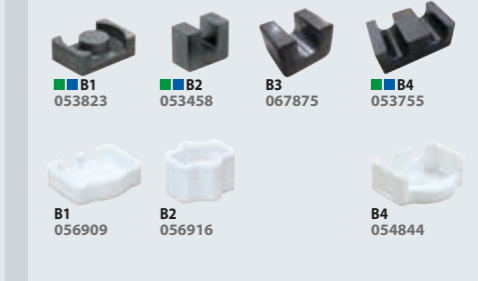

B1 053823
B2 053458
B3 067875
B4 053755

B1 056909
B2 056916
B4 054844

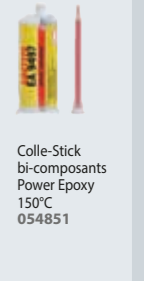

Colle-Stick bi-composants Power Epoxy 150°C 054851



PLASMA

1~

06/2021

NEW DESIGN

with TPT 25

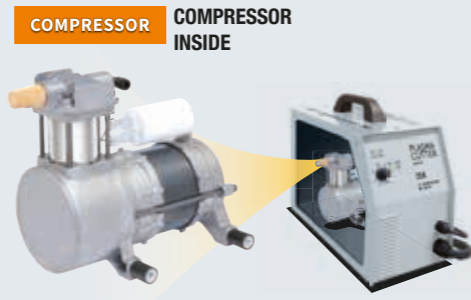
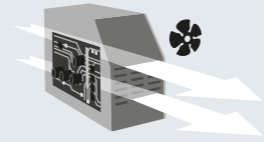
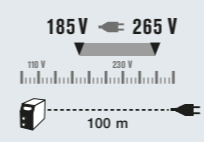
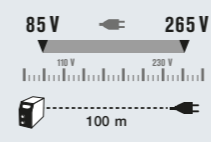
**COMPRESSOR** COMPRESSOR INSIDE**AD** ANTI-DUST VENTILATION CORRIDOR**PFC** POWER FACTOR CORRECTION**FV** FLEXIBLE VOLTAGE

Plasma torch TPT 40, 4m 060753

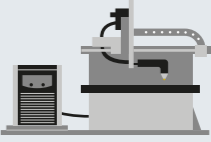
**CNC** COMPUTER NUMERICAL CONTROL**AIR FILTER****PFC** EN 61000-3-12 POWER FACTOR CORRECTION**IDEAL CARBODY REPAIR****PFC** EN 61000-3-12 **FV** FLEXIBLE VOLTAGE**DIGITAL (PRESSURE SENSOR)****DIGITAL (PRESSURE SENSOR)**

INCLUDED: 8 mm

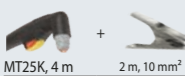
**COMPRESSOR** Compressor inside**CUTTER 25 K****230 V • 1 ~****25 A** Fe 8 mm Al/CrNi 6 mm**P400 COMPRESSOR**

030947

CUTTER 35 KF**230 V • 1 ~****35 A** Fe 15 mm Al/CrNi 10 mm**P400 PFC AD COMPRESSOR**

031036

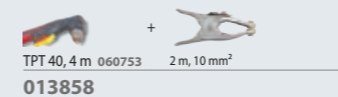
CUTTER 30 FV**110 → 230 V • 1 ~****30 A** Fe 15 mm Al/CrNi 10 mm**P400 PFC FV**

013858

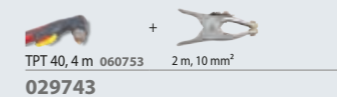
EASYCUT 40**230 V • 1 ~****40 A** Fe 18 mm Al/CrNi 15 mm

029743

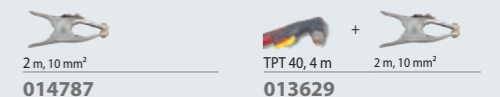
CUTTER 45 CT**110 → 230 V • 1 ~****45 A** Fe 30 mm Al/CrNi 20 mm**P400 PFC FV GRID CUT AD IP 23 CNC ANALOGIC**

014787

013629

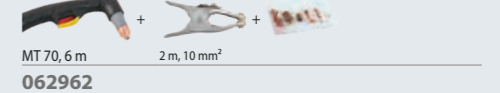

062962

COMPAS for TPT 40, MT 25K / MT 35K

x1 040199



040205



R max = 670 mm

Consumables

	CUTTER 25 K		CUTTER 35 K		CUTTER 30 FV / EasyCut 40 / CUTTER 45 CT	
	MT25K	MT35K	TPT40	TPT35	TPT40	TPT35
	x4 040182	x1 040229	x4 040236	x1 040236	x1 040236	x1 040236
	x10 040151	x3 040212	x10 040212	x3 040212	x10 040212	x3 040212
	x2 040175	x1 040175	x2 040175	x1 040175	x2 040175	x1 040175
	x10 040168	x3 040168	x10 040168	x3 040168	x10 040168	x3 040168
Coffret - Box	039971	039964	039957			

Chariot - Trolley

PLASMA 600 040298

Universal 800 051331

Jobsite XL 039568

Filtre déshumidificateur spécial Plasma - Compressed air cleaning filter for Plasma Cutter 40 039728

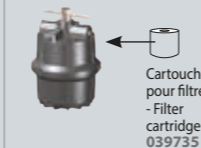

Cartouche pour filtre - Filter cartridge 039735

Logo	Model	Voltage	I ₂	Coupe max Severance cut				Coupe propre Clean cut			Perçage Piercing			INTEGRATED TECHNOLOGY						AIR SYSTEM			EN 60974-1 (40°C)		kg	Protected & compatible power generator (+/-15%)								
				Fe	Al/CrNi	Fe	Al/CrNi	Fe	Al/CrNi	P400	PFC	FV	GRID CUT	AD	IP23	CNC	COMPRESSOR	min	ideal	max	I _{60%}	X% I _{2max}	100%	cm										
MADE IN FRANCE	CUTTER 25K	230V1~	16	5 → 25	8	6	6	4	—	—	—	—	—	—	—	—	—	—	—	—	—	—	—	—	—	—	—	—	—	—	—			
	CUTTER 25K New	230V1~	16	5 → 25	8	6	6	4	—	—	—	—	—	—	—	—	—	—	—	—	—	—	—	—	—	—	—	—	—	—	—			
MADE IN FRANCE	CUTTER 35KF	230V1~	16	10 → 35	15	10	10	8	—	—	—	—	—	—	—	—	—	—	—	—	—	—	—	—	—	—	—	—	—	—	—	—		
	EASYCUT 40	230V1~	32	10 → 40	18	15	15	10	—	—	—	—	—	—	—	—	—	—	—	—	—	—	—	—	—	—	—	—	—	—	—	—		
MADE IN FRANCE	CUTTER 30FV	230V1~	16	10 → 30	15	10	10	8	—	—	—	—	—	—	—	—	—	—	—	—	—	—	—	—	—	—	—	—	—	—	—	—	—	
		110V1~	32	10 → 30	32	10 → 30	32	10 → 30	32	10 → 30	—	—	—	—	—	—	—	—	—	—	—	—	—	—	—	—	—	—	—	—	—	—	—	—
	CUTTER 45CT	TPT 40	230V1~	16	15 → 45	20	15	15	10	8	6	—	—	—	—	—	—	—	—	—	—	—	—	—	—	—	—	—	—	—	—	—	—	—
		MT 70	230V1~	32	15 → 30	15	10	10	8	—	—	—	—	—	—	—	—	—	—	—	—	—	—	—	—	—	—	—	—	—	—	—	—	—
MADE IN FRANCE	CUTTER 45CT	MT 70	110V1~	32	15 → 45	30	20	25	15	12	10	—	—	—	—	—	—	—	—	—	—	—	—	—	—	—	—	—	—	—	—	—	—	—
			110V1~	32	15 → 30	15	10	10	8	—	—	—	—	—	—	—	—	—	—	—	—	—	—	—	—	—	—	—	—	—	—	—	—	—

COFFRET DE DÉCOUPE PARE-BRISE
- Professional Box Set for Windscreen Removal - Frontscheiben-Trennsystem für Akkuschrauberbetrieb

057654

included
65 m
058125

included
Axe enrouleur
068100

MADE IN HIGH QUALITY GERMANY

COUPEAU PNEUMATIQUE DE DÉCOUPE PARE-BRISE
- Oscillating Pneumatic Saw for Windscreen Removal - Druckluft-Trennmesser für Windschutzscheiben

057623

Included
57 mm
057845

90 mm
057852

8 mm
057876

35 mm
057838

U
36 mm
057869

EXTRACTEUR D'ESSUIE-GLACE - Removal tool for windscreen wiper arms - Wischerarm-Abzieher

UNIVERSEL
057630

EXPERT
Accès difficile
- Difficult access
057647

30 mm max

40 mm max

SYSTÈME DE DÉCOUPE PARE-BRISE A CLIQUET
- Windshield Cutting kit - Set zum Lösen von Windschutzscheiben

054738

PROTECTIONS TABLEAU DE BORD
- Dashboard Protector - Armaturenbrett Schutz

053120

45 cm

27 cm

45 cm

27 cm

VENTOUSES - Suction Lifting Pads - Saugnapfwerkzeug für Spiegelgläser

056695

Ø 70 mm

051966

x2

x6
057609

OUTIL DÉCOUPE PARE-BRISE
- Windshield Cutting Tool - Windschutzscheiben Demontage-Set

051935

KIT DÉCOUPE JOINT DE PARE-BRISE - Windscreen Joint-cutting Kit - Scheibentrenn-Werkzeug-Set

051898

051911

051881

Corde à piano torsadé (22 m)
- Windscreen seal cutting wire (twisted)
- Piano-Schneiddraht, gedreht, 22 m Rolle

Corde à piano carré (50m)
- Windscreen seal cutting wire (square)
- Vierkant-Draht, 50 m Rolle

RENOV'POLYCARBONATE - Compressed air polisher - Druckluftpolierer

Complete pack
+ 1 lustreuse
- 1 orbital sander
+ 1 polisher

052086

2 SPEED

052055

052062

052079

sander Ø75
057494

polisher Ø75
058224

Ø 76

P 500 (x 10)
P 800 (x 10)
P 1500 (x 10)
P 3000 (x 10)

P 500 x 50 052017
P 800 x 50 052024
P 1500 x 50 052031
P 3000 x 50 052048

AGRAFEUSE POUR RÉPARATION PARE-CHOCs - Hot stapler for bumper repair - Stoßstangen Reparatur Kit

052925



INCLUDED:
x20 x20 x20 x20 x20

MADE IN TAIWAN

PORTABLE
Sur batterie - Battery operated
058118

included
Li-ion battery 3.7 V
048669
included adapters:
EUR, UK, USA & AUS

Charger included
048652

MADE IN TAIWAN



INCLUDED:
Ø 0.6, x100 Ø 0.8, x100
Ø 0.6, x100

Adjustable

Agrafes - staples

Angle interne étroit - Inside corner Ø 0.7 mm	Alignement de fissure - Crack alignment Ø 0.7 mm	Fissure importante - Large crack Ø 0.7 mm	Angle interne - Internal angle Ø 0.7 mm	Angle externe - External angle Ø 0.7 mm
x 100 047990	x 100 047983	x 100 047976	x 100 047969	x 100 047952
052413				
=	+	+	+	+
x 50	x 50	x 50	x 50	x 50

STATION DE SOUDAGE DES PLASTIQUES - Plastic welding station - Kunststoff-Schweißset

320 W - 230 V, 1-50 Hz
Temperature: 160 to 480°C
3.4 kg
Length of hose: 1 m
Air flow: 24 l/min

062726



Ø 5 mm included
066694
Ø 8 mm included
066700

Station seule - Station only
064072

INCLUDED	440 mm	PP / EPDM	4 mm x 10	066304
			6 mm x 10	067622
			8 mm x 10	066298
OPTION	440 mm	PP / EPDM	5 mm x 10	063242
			10 mm x 10	063259
		ABS	5 mm x 10	063372
			10 mm x 10	063266

OPTION

Trolley SPOT 600
053533



NEW

Grattoir - Scraper
068032



x2
068049



Included
058231



Included
Tungsten drill Ø 5 mm
063235

KIT DE SOUDAGE DES PLASTIQUES - Welding Kit for Plastics - Kunststoff-Schweißset

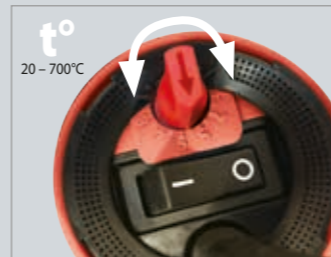

1 600 W - 230V - 50/60 Hz
max. 230 l/min
1.3 kg / -L Ø100 x 300mm,
poignée Ø 56mm.

057678

3m

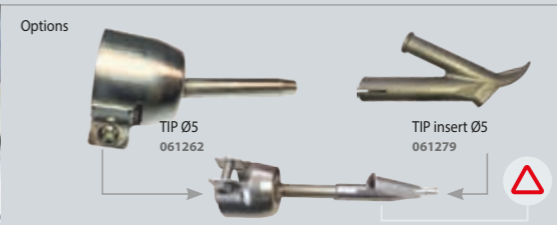
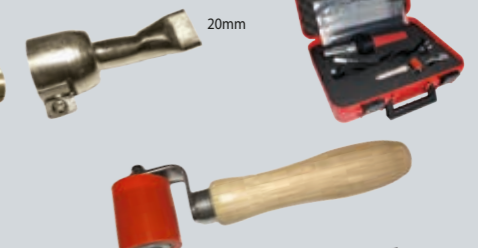

Options

TIP Ø5
061262

TIP insert Ø5
061279

x10
052956
x1
25 x 12.5 cm
052949

COFFRET DE PERÇAGE PARE-CHOCs POUR DÉTECTEURS - Piercing Kit for Bumper Sensors - Lochwerkzeug für Stoßfänger



PRO +
059139

Ø 17-18-18,2
19-20-22,5-24
26-26,7-32 mm



FREEZER

Spray refroidisseur - Freezer spray

-50 °C

400 ml

(x 12)

048898



COFFRET DE RÉPARATION DES PLASTIQUES AUTOMOBILES - Brazing automotive plastics repair kit - Kunststoff Reparatur Set

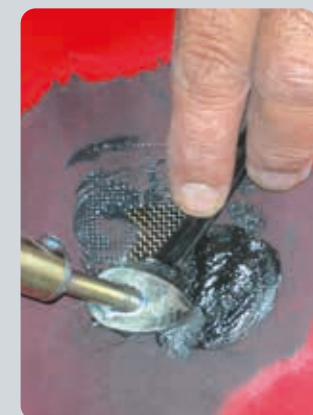

052932

MADE IN BELGIUM



x10
052956

25 x 12.5 cm
x2
052949

057258

052963

STATION DE SOUDAGE À ULTRASONS DES PLASTIQUES

- Ultrasonic welder - Ultraschall-Kunststoffschweißgerät



230 V
Output 40 kHz - 800 W
29 x 22 x 12 cm
3 kg
0.8 kg (gun)

067868

MADE IN ITALY



NEW

Touch screen
6 languages
Timer control

included
2 Titanium sonotrodes



GYS HAND TOOLS - Ausbeulwerkzeug

● **FULL PACK =**
061637

● 053311 ● 053298 ● 061309 ● 053335 ● 053342 ● 053328 ● 053281

● **MEDIUM PACK**
051133

● 051430 ● 051416 ● 051454 ● 051447 ● 051409

MADE IN HIGH QUALITY GERMANY

0.70 kg 051485
0.95 kg 051478
1.33 kg 051461

051423

(9 dents/pouce - 9 teeth/inch) 062351
(15 dents/pouce - 15 teeth/inch) 062368

KIT MARTEAUX ET TAS - Planishing Kit for Car Body (Set of 3 Hammers + 4 Dollies) - Karosseriehammer & Handfaust Kit

057579

40 x 40 mm
70 x 90 mm
1.4 kg
061408

117 x 57 mm
1.2 kg
061415

117 x 57 mm
1.2 kg
061422

OUTILS DE FORME - Forming tools - Formgebungswerkzeuge

051195

180 x 70 x 65 mm
280 x 95 mm
75 x 65 mm

OUTILS DE DÉGARNISSAGE ET RACLAGE - Set of 30 Tools for scraping/sanding and paint removal - Polster & Schaber Kit

057616

BURINS - Hand Chisel for Car Body - Meißel für Karosserie

26 x 7 mm
057586

60 x 11 mm
057593

COUTEAUX RACLOIRS

061439

15 mm
20 mm
30 mm

JEU DE 4 BURINS EN NYLON - Set of 4 nylon chisels - 4 Kunststoffmeißel

054745

273 mm

19 mm (x1)
22 mm (x1)
25 mm (x1)
38 mm (x1)

JAUGES DE PROFIL - Contour Gauge - Konturenlehre

052840 ● 057265

250 mm
500 mm

JAUGES DE POSITIONNEMENT - Gapping gauges - Spaltmaßlehre

x2 054752

OUTIL DE REMISE EN FORME PASSAGE DE ROUE - Fender roller tool set

060791

REDRESSEUR DE CHARNIÈRE DE PORTE - Fixed Hinge Bending Tool

051102

Redresseur de charnière de porte
- Door hinge straightener
- Türgelenkausrichter

40 mm max

PINCES DE MAINTIEN BORD À BORD - Positioning clamp - I-Stoß-Lehre

(x4) 043190

PINCES MICRO-GRIP - Micro-grip clamps

(x4) 061330

20 mm max
95 mm

PINCES ÉTAU À BEC PLAT - Flat noze lock-grip pliers

062719

250 mm
100
max 25
75
200 mm
max 20

PINCES AXIALES - Axial-grip pliers

050242

Type I ● Type J ● Type JJ ● Type W ● Type LL ● Type G

280 mm 061378 (x6)
80 mm

610 mm 061354 (x2)
410 mm

460 mm 061361 (x4)
240 mm

Flat noze - 610 mm 061347 (x2)
410 mm

PINCES ÉTAU MONO SERRAGE - Lock-grip pliers

Flat noze - 460 mm 050112 (x6)
240 mm

KIT: 050266

Flat noze 280 mm (x3)
x3 ● x3 ● x5 ● x5 = 16

MINI-MEULEUSE - Mini disc sander - Druckluftschleifer

051829

Speed adjustment

Ø 75 mm

Speed rpm	Power W	dB	Air consumption l/min	Air pressure bar	cm	kg
18000	200	83	171	6.2	12	0.7

Included (x1) 052468

MEULEUSE D'ANGLE - Long Handled Angle Grinder - Druckluft-Winkelschleifer

057753

Ø 100 mm

± 1.6 mm, x5 057883
± 0.8 mm, x5 058217

Speed rpm	Power W	dB	Air consumption l/min	Air pressure bar	cm	kg
14000	84	113	6.2	37	1.7	

058248

MINI-FLEXIDISC LAMELLES ZIRCON
Ø 50 mm

K 40 (x10) 058255
K 60 (x10) 058262
K 80 (x10) 058279

x2 Ø
Ø 50 & 75 mm

Speed rpm	Power W	dB	Air consumption l/min	Air pressure bar	cm	kg
15000	84	91	6.2	10	0.6	

MINI-MEULEUSE À RENVOI D'ANGLE - Mini Angle Grinder - Mini-Druckluftwinkelschleifer geräuschgedämpft

051867

Ø 50 mm

90°

Speed rpm	Power W	dB	Air consumption l/min	Air pressure bar	cm	kg
15000	200	86	85	6.2	18	0.75

(x1) 052772

PONCEUSE À BANDE À TÊTE ORIENTABLE - Air belt sander - Druckluft Bandschleifer

060906

360°

520 mm

20 mm

Grain 60 (x5) 060913
Grain 80 (x5) 060920
Grain 100 (x5) 060937
Grain 36 céramique (x5) 062535

Speed rpm	Air consumption l/min	Air pressure bar	cm	kg
16 000	171	6.3	34	1.2

SCIE COUPE TÔLE DROITE ET LIME - Saw for Straight Cut and File - Druckluftsäge und Feile

051805

(x5) 052789

included 058750

Speed rpm	Power W	dB	Air consumption l/min	Air pressure bar	cm	kg
5000	—	85	255	6.2	10	0.8

PONCEUSE À BANDE À TÊTE ORIENTABLE - Air belt sander - Druckluft Bandschleifer

052819

360°

330 mm

10 mm

Grain 80 (x10) 052833
Grain 36 céramique (x20) 062528

Speed rpm	Air consumption l/min	Air pressure bar	cm	kg
16000	171	6.3	26	0.9

MINI-FRAISEUSE À RENVOI D'ANGLE - Mini Angle Milling Machine - Mini-Winkelschleifer

051836

90°

Speed rpm	Power W	dB	Air consumption l/min	Air pressure bar	cm	kg
18000	500	81	85	6.2	18	0.7

PERCEUSE MANDRIN AUTOMATIQUE - Automatic Mandrel Drill - Druckluftbohrmaschine m. Schnellspannfutter

051799

Ø 13

Speed rpm	Power W	dB	Air consumption l/min	Air pressure bar	cm	kg
800	300	92	170	6.2	18	0.9

COFFRET DÉCAPEUSE PNEUMATIQUE - Pneumatic surface remover Kit - Druckluftentroster-Box inkl. Zubehör

051775

Speed rpm	Power W	dB	Air consumption l/min	Air pressure bar	cm	kg
4000	500	86	102	6.2	280	1.2

Roue gomme 115 x 14 mm 051874
Roue à décaper 115 x 14 mm 051843
Adaptateur pour brosse 051768

Brosse souple Brins droits 0.5 mm 103 x 23 mm 052598
Brosse dure Brins incurvés 0.7 mm 103 x 23 mm 051812
Brosse souple Brins incurvés 0.5 mm 103 x 23 mm 051850

PINCE À SOYER ET À TROUER, Ø5MM PNEUMATIQUE - Pneumatic flange / ø5 mm punching tool - Pneumatische Loch- und Absatzzange Ø 5 mm

052543

2 in 1

Ø 5 mm

0.8 > 1.2 mm

0.8 > 1.2 mm

MINI FRAISEUSE - Mini milling machine - Mini-Schleifer

063228

NEW

Option

Tungsten drill Ø 6 mm 054172

POINÇONNEUSE PNEUMATIQUE OBLONG - Pneumatic oval punching tool - Pneumatische Langloch-Blechzange

for MIG brazing 053182

6 mm 20 mm
1.2 mm max

included 6x20 53515

BODY ZIPPER - Sertisseuse pneumatique Pneumatic Crimper - Druckluftkantenformer

056930

MADE IN HIGH QUALITY POLAND

1) MINI
2) initial W
3) final M x < 2.4mm
4) final D x > 2.4mm

Air pressure bar	cm	kg
5	28	2.1

DÉPOINTEUSE POUR CORDON LASER ACIER - Laser cord metal sheet cutter (nibbler) - Trennwerkzeug für Lasernähte

054165

Ø 6 mm

STEEL Included 054172

Outil de poinçonnage oblong - Punching tool for oval holes - Langlochkarosserieblechzange

2.2 kg

6 mm 20 mm 052437
8 mm 20 mm 067264

DÉPOINTEUSE - Spot remover - Druckluft-Schweißpunktbohrer

SPOT DRILL 050464

360°

Ø 8

Included: Tungsten Carbide Ø 8 for BORON/UHSS (x1)

HIGH QUALITY

Speed rpm	Power W	dB	Air consumption l/min	Air pressure bar	cm	kg
800	400	85	140	6.5	35	2.3

Forets de dépointage - Spot remover drill - Schweißpunktfräse
Tungsten Carbide for BORON/UHSS

3-edge Ø 8 mm 053069 Ø 10 mm 053076
4-edge Ø 8 mm 059849 Efficiency ++ Durability ++



PACK SPOT DRILL + 140 mm 061460

140 mm 061453

3-edge Ø 8 mm 053069

TOURNEVIS SANS FIL - Cordless Mini Screwdriver - Akkuschrauber



DÉTECTEUR ÉPAISSEUR DE PEINTURE - Film coating thickness gauge

Measurement range : 0 - 1.80mm
 Resolution : 0.01 mm / 1mm
 Measurement error : +/- 0.03 mm
 Power Supply : 2x 1.5V AAA batteries (included)
 Overall dimensions : 62 x 30.5 x 105 mm
 059856



TOURNEVIS À CHOCS SANS FIL - Cordless Impact Screwdriver - Akkuschrauber



PONÇEUSE / POLISSEUSE ÉLECTRIQUE - Electric Sander & Polisher - Elektro-Polier-Schleifer

057999
 Orbital 5.0 mm
 303 x 101 mm
 1.21 kg
 Speed : 4000, 7000, 9000 10000 rpm
 AC-in 220V - 230V / 50 - 60Hz



Light weight
 & Compact

ASPIRATEUR PNEUMATIQUE POUR POUSSIÈRES ALU (ATEX) - Pneumatic aluminium dust atex vacuum cleaner

058866
 Dust container capacity : 25 l
 Working compressed air pressure : 7 bar
 Compressed air consumption at 6 bar : 800 l/min
 Suction connection diameter size : 50 mm
 Max suction capacity : 150 m³/h
 Max vacuum level : 2000 mm H₂O
 Recommended compressor power : 7.5 HP



058293
 Power supply : 230V / 50Hz
 Power : 1400W (max 2000W)
 Max. vacuum : 170 mbar
 Air flow : 2700 l/min
 Drum capacity : 30 L
 Drum material : stainless steel
 380 x 380 x 700 mm
 7 kg



included
 Filtre - Filter
 058873

included
 Sac à poussières - Filter bag
 Capacity 5 kg
 058880

5 m Output Ø 29 mm Input Ø 35 mm

TIG AC/DC

GTAW AC/DC
RÉPARATION DE JANTES



PROTIG 201 AC/DC HF FV
200 A 110 → 230V • 1~
 P400 PFC FV SR VRD inside TIG PULSE
 L/DB/P AD MMA PULSE

TIG 220 AC/DC HF FV
220 A 110 → 230V • 1~
 P400 PFC FV SR
 AID TIG PULSE WAVE FORMS
 CONNECT 5 ARC ON L/DB/P
 MMA PULSE IP 23

Métaux d'apport TIG - TIG filler rods - WIG-Schweißstäbe

5 kg (L = 1 m)	X...	
Alu - Aluminium - Aluminio (AIMg5)	Ø 1.6 920	087170
Normes - Norms - Normen - Norma	Ø 2.0 590	087187
AWS A 5.10 : ER 5356	Ø 2.4 410	087194
EN ISO 18273 : 5 Al 5356		

Électrodes tungstène - Tungsten electrodes - Wolfram Elektroden

WP PUR (AC)	Alu - Aluminium - Aluminio	
Ø 2.0	x10	046719
Ø 2.4	x10	044579

SR 17 - SR 18 - SR 26
 AC / DC 044678
 Back cap (short+long)
 Tungsten electrode
 Tungsten electrode WR2 Ø 1.6 & Ø 2.4 + collets
 Gas nozzle N5 - N7

COMPLETE PACKS

pack PROTIG 201 AC/DC 065710	SR26 DB, 4 m 038271	2 m, 25 mm² (original equipment)	2 m, 25 mm² (original equipment)	550 x 1115 x 525 mm 039704
pack TIG 220 AC/DC 028388	SR26 DB, 4 m 038271	4 m, 25 mm² 043794		702 x 800 x 352 mm 037489

FOOT PEDAL RC-FA1(4 m) 045682

Débitmètre bout de torche Torch Gas Flow Meter Durchflussmessrohr 053939

15L/min (FR) 041998 (UK) 040274 (NL) 040267 (IT) 038691
 30L/min (FR) 041622 (UK) 041646 (DE) 041219 (NL) 041615 (IT) 038707

CE NORM EN60974-1	MADE IN FRANCE	I ₂ TIG A	INTEGRATED TECHNOLOGY										TIG		MMA		Freq. AC	U _o	mm ²	cm	kg	Protected & compatible power generator (+/-15%)			
			EN60974-1 (40°C)		EN60974-1 (40°C)		EN60974-1 (40°C)		EN60974-1 (40°C)		I (60%)	X% (I2 max)	I (60%)	X% (I2 max)											
			I (60%)	X% (I2 max)	I (60%)	X% (I2 max)	I (60%)	X% (I2 max)	I (60%)	X% (I2 max)															
PROTIG 201 AC/DC-HF FV	110V-1~	20	10→160	10→160										AC 105 A	DC 120 A	AC 20%	DC 25%	90 A	32%	20 → 200	70 V	Ø 13, 35/50	41 × 36 × 24	15	7.5 kW
	230V-1~	13	10→200	10→160										AC 30 A	DC 100 A	AC 13%	DC 25%	100 A	25%						
TIG 220 AC/DC-HF FV	110V-1~	32	10→140	5→140										AC/DC : 140 A	AC/DC : 100%	140 A	75%	20 → 200	75 V	Ø 13, 35/50	62 × 46 × 35	22	8.5 kW		
	230V-1~	16	10→220	5→220										AC 185 A	DC 175 A	AC 45%	DC 35%	160 A	25%						

LAMPES BALADEUSES - Hand lamps - Handleuchte

Lampe BALADEUSE TRIPODE 250 L
100-250 lumens (x3)
 3 x 1 W COB LED
 3 x 3.6 V - 300 mAh
 AAA rechargeable, Ni-MH
 USB charging (6h)
operating time
 High position : 1 h
 Low position : 3 h
 Flashing : 5 h
 ↳ 260 x 100 x 100 mm
 059955



Lampe BALADEUSE 400 L
400 lumens
 COB LED
 Li-ion
 Charging time : 8h
operating time
 High position : 2.5 h
 Low position : 5 h
 Top light (1 W) : 6 h
 ↳ 230 x 65 x 40 mm
 059153



Lampe BALADEUSE ÉTANCHE 400 L
200-400 lumens
 COB LED
 3.7 V - 2000 mAh Li-ion
 USB charging (4/6 h)
 mains charger not included
operating time
 High position : 2 h
 Mid position : 4 h
 Top light (4 W) : 3 h
 ↳ 285 x 65 x 65 mm
 IP 56
 059948



Lampe BALADEUSE PRO 600 L
250-600 lumens
 COB LED, 80 CRI
 3.7 V - 2200 mAh Li-ion
 micro USB charging (3.5 h)
operating time
 High position : 1.5 h,
 Mid position : 4.5 h,
 Top light (100 lumens) : 10 h
 ↳ 190 x 56 x 29 mm
 IP 54
 210 g
 060883



Lampe AMBIANCE 360° PORTABLE 1000 L
60-1000 lumens
 >80 CRI SMD LED
 6500 K
 3.7 V - 5200 mAh Li-ion
 USB charging (4.5h)
 USB power supply
operating time 2 > 27 h
 ↳ 260 x 75 x 75 mm
 IP 54
 450 g
 059764

LAMPES D'INSPECTION - Inspection lamps - Inspektionslampen

Lampe INSPECTION FRONTALE 280 L
100-280 lumens
 3 W COB LED, 80 CRI+, 6500 K
 3.7 V - 1500 mAh Li-po
 micro USB charging
 mains charger not incl.
operating time
 High position : 2 h
 Low position : 6 h
 IP 65
 ↳ 110 g
 ↳ 78.5 x 47.5 x 42 mm
 060845

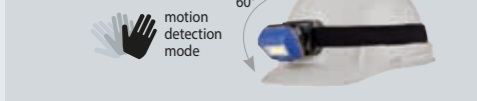

Lampe INSPECTION MINI 200 L
120-200 lumens
 COB LED, 80 CRI, 6500 K
 3.7 V - 700 mAh Li-ion
 micro USB charging (2.5 h)
 mains charger not included
operating time
 High position : 1.5 h
 Low position : 4 h
 Top light : 3.5 h
 IP 20
 ↳ 76 g, ↳ 174 x 27.5 x 28 mm
 060852

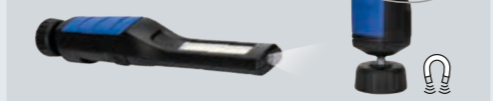

Lampe INSPECTION FLEXIBLE 500 L
50-500 lumens
 COB LED
 80 CRI+
 6500 K
 3.7 V - 2600 mAh Li-ion
 USB charging (4 h)
operating time
 High position : 2 h
 Low position : 16 h
 Top light : 9.5 h
 IP 54
 ↳ 290 g
 ↳ 423 x 65.5 x 44.5 mm
 060869

Lampe INSPECTION PRO 600 L
0-600 lumens
 COB LED
 6500 K
 3.7 V - 2600 mAh Li-ion
operating time
 1.5 > 15 h
 ↳ 380 x 40 x 45 mm
 300 g
 057760
 058309

LAMPES SOUS CAPOT - Under bonnet lamps - Leuchte für Motorhaube

Lampe SOUS CAPOT 600 L
300-600 lumens
 120 COB LED
 3.7 V - 4000 mAh Li-ion
 charging time : 10/12 h
operating time
 High position : 1.5 h
 Low position : 3 h
 1.3 kg
 059962



Lampe SOUS CAPOT 800 L
250-800 lumens
 120 COB LED
 3.7 V - 4000 mAh Li-ion
 charging time : 10/12 h
operating time
 High position : 3 h
 Low position : 6 h
 058002
 058316

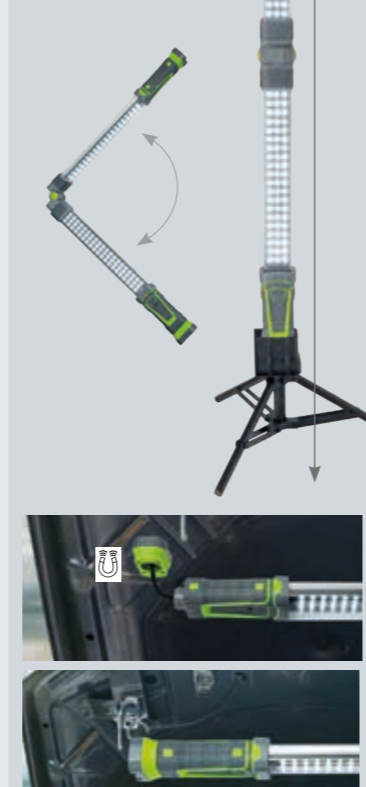

PROJECTEURS LED SUR TRÉPIED - LED worklights with tripod - LED-Arbeitsleuchte mit Standfuß

Lampe sur TRÉPIED 1600 L
800-1600 lumens
 Li-ion
 Charging time : 3/4 h
operating time
 Floodlight : 3 h
 Torch : 4 h
 Side light of the torch : 12 h
 3 modes together - 2 h
 IP 44
 060890



Lampe sur TRÉPIED 1800 L
1800 lumens
 3x 55 COB LED
 total 165 LED
 1.8 m power cord
 059146



Lampe sur TRÉPIED 3000 L
3000 lumens
 35 W COB LED
 2 m power cord
 IP 44
 059979



Lampe sur TRÉPIED 4000 L
4000 lumens
 3x 20 COB LED,
 total 60 LED
 3 m power cord
 059986

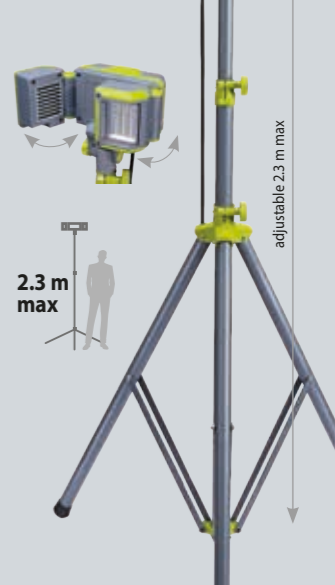

CONTRÔLE DES COULEURS - Detailing & colour match - Fabnpassung & Aufbereitung

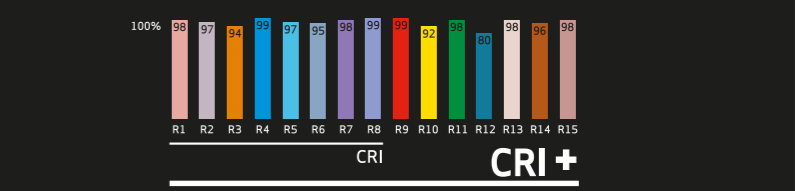

4500 K
400 lumens
SUNCOLOR 1
 COB LED, CRI > 95, 1100 lux
 3.7 V - 2600 mAh Li-ion
 USB charging
operating time : 4.5 h
 ↳ 190 x 56 x 29 mm
 290 g
 IP 65
 058477



3 COLORS
2700 - 4500 - 6500 K
350-420-450 lumens
SUNCOLOR 3
 COB LED, 96 CRI+
 3.7 V - 2600 mAh Li-ion
 micro USB charging (4 h)
operating time : 2.5/4 h
 IP 65
 ↳ 190 x 56 x 29 mm, 290 g
 060838

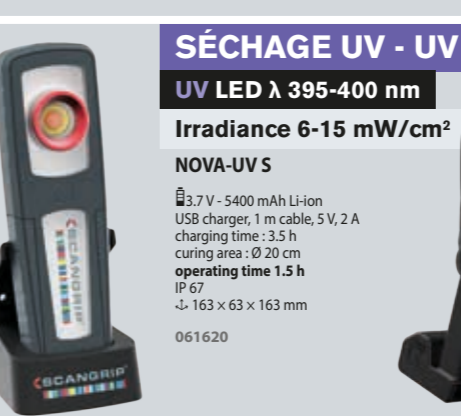

5 COLORS
2700 - 3500 - 4500 - 5500 - 6500 K
500-1000-2000 lumens
SUNCOLOR 5
 COB LED, 96 CRI+
 11.1 V - 4400 mAh Li-ion
 charger 110/240 V, 5 m cable, 15 V, 1.5 A
 charging time : 3.5 h
operating time
 High position : 2 h, Mid : 4 h, Low : 8 h
 IP 65
 ↳ 225 x 200 x 70 mm, 1.2 kg
 060876



5 COLORS
2500-3500-4500-5500-6500 K
250-500 lumens
SUNMATCH 3
 COB LED, 96 CRI+, 700-1400 lux
 3.7 V - 2600 mAh Li-ion, USB charging
operating time :
 High position : 2 h, Low position : 4 h
 IP 65
 ↳ 204 x 89 x 81 mm, 270 g
 061651

SÉCHAGE UV - UV CURING
UV LED λ 395-400 nm
Irradiance 6-15 mW/cm²
NOVA-UV S
 3.7 V - 5400 mAh Li-ion
 USB charger, 1 m cable, 5 V, 2 A
 charging time : 3.5 h
 curing area : Ø 20 cm
operating time 1.5 h
 IP 67
 ↳ 163 x 63 x 163 mm
 061620



TRÉTEAUX - Frames support - Klappböcke

040601 100.5 x 112 cm - 5.5 kg
35 x 95 x 106 cm

040311 104.5 x 117 cm - 8.1 kg
32 x 10 x 106 cm

040250 100 x 105 cm - 7kg
32 x 10 x 106 cm

040304 104.5 x 108.8 cm - 8.1kg
32 x 10 x 106 cm

4 ventouses
Dépose vitrages
- Suction pad for glazing
- Gummiteiler zur Fixierung von Glasscheiben

4 pieds coudés
Idéal sur callebotis
- Bent feet for grating
- Abgewinkelte Standfüße:
Sicherer Stand auf Gittern u.ä.

Ø 28 mm

Ø 32 mm

Ø 32 mm

Ø 32 mm

24 kg

18.5 > 132 cm

81 > 133 cm

059818

86 cm

MADE IN HIGH QUALITY POLAND

Chaînette réglable
- Adjustable catenary

Mousse de protection
- Protecting foam

Antidérapants
- Non-slip base

**SUPPORT PARE-CHOCS - Rotary element support
Lackierständer für Stoßstange, einstellbar**

052376 91 x 105 cm - 7.6 kg
60 x 11 x 75 cm

059825 106 x 104 x 215 cm - 32.5 kg
112 x 31.5 x 21.5 cm
+ 12 x 9.5 x 194.5 cm

059832 50 x 150 cm - 13 kg
152 x 15.5 x 11.5 cm

50 cm

50 cm

50 cm

Adapté aux coques de rétroviseurs
- Adapted to wing mirror covers
- Geeignet für Außenspiegel

**SUPPORT ÉLÉMENT ROTATIF - Rotary element support -
Lackierständer für Stoßstange, einstellbar**

052611 200 x 101 cm - 17.5 kg
35 x 15 x 110 cm
Made in China

PRO 056725 200 x 105 x 81 cm - 22 kg
24 x 17 x 118 cm

MADE IN HIGH QUALITY POLAND

1.5 mm

360°

2 mm

Verrouillage de l'axe - Locking of the axis
- Verriegelung der Achse

**CHARIOT EXTENSIBLE POUR ÉLÉMENTS DE CARROSSERIE -
Extendable support - Ausziehbarer Wagen**

061507 max 150 kg

100 cm

135 - 210 cm

26 kg
114.5 x 42 x 13.5 cm

MADE IN HIGH QUALITY POLAND

**CHARIOT DE LUXE MAROUFLAGE - Premium masking machine -
Abdeckpapier-Ständer**

MADE IN HIGH QUALITY POLAND

x 5 rouleaux de papier
- Papierständer
- Paper roll
30 > 120 cm

057333 150 x 133 x 62 cm
32 kg
152 x 17 x 29 cm

Ø 40 mm
x 6
058897

**CHARIOT DE MAROUFLAGE - Masking machine -
Abdeckpapier-Ständer**

MADE IN HIGH QUALITY POLAND

x 3 rouleaux de papier
- Papierständer
- Paper roll
30, 60, 90 cm

056954 150 x 62 x 110 cm
- 12 kg
122 x 29 x 17 cm

**CHARIOT DE STOCKAGE - Storage trolley -
Lagerrollwagen**

040243

71 x 90 x 197cm
41 kg
x2: 90 x 6 x 147 cm
+ 97 x 74 x 24 cm

TIGES DE BLOCAGE - Flap Lock

056732

36 > 115 cm

057555 38 x 38 x 44 cm - 6 kg
40 x 40 x 18 cm

**TABOURET - Round Stool with Tool Storage -
Werkstatt-Rollhocker**

057555 38 x 38 x 44 cm - 6 kg
40 x 40 x 18 cm

max : 50 cm
min : 38 cm

SERVANTE 3 PLATEAUX - Workstation 3 shelves

068056

835 mm

390 mm

800 mm

NEW

**CHARIOT DE VISITE - Mechanics Creeper With
Tilting Headrest - Werkstatt-Rollliege**

057548 102 x 43 x 11 cm
7.2 kg
11 x 44 x 13 cm

**MARCHE PIED - Folding Step Stool
(Aluminium) - Arbeitspodest klappbar**

ALU 200 kg

057562 8.2 kg
102 x 41 x 59 cm

960 mm

385 mm

475 mm

**CHARIOT POUR ÉLÉMENTS DE CARROSSERIE -
Universal support - Universelle Ständer**

066281 20 kg max 80 kg

80 cm

Ø 12.5

70-100 cm

115 cm

NEW

MADE IN HIGH QUALITY POLAND

ALU 150 kg

1090 > 1750 mm

520 > 900 mm

300 mm

058552 15.5 Kg
116 x 43 x 17 cm - 16.5 kg

COUVERTURE ANTI-CHALEUR - Heat cover - Hitzeschutzdecke - Manta anti-calor - Protecção anti-aquecimento

PROTEC 550
550°C/1000°F - Class M0
2m x 2m - 580 g/m²
050495

PROTEC 1200
1200°C/2200°F - Class M0
1,75 m x 1,5 m - 1200 g/m²
050204

PROTEC 1300
1300°C/2400°F - Class M0
XL: 2 m x 1,8 m - 620 g/m²
053595

PROTEC 1300L
1300°C/2400°F
XL: 2 m x 1,8 m - 427 g/m²
060500

JEU DE 2 AIMANTS
- Set of 2 magnets -
Schweißmagnet

(x2)
052291

COUVERTURE MAGNÉTIQUE - Magnetic cover - Magnetschutzdecke



1,06 m x 0,6 m
061446

RIDEAU DE SOUDAGE - Welding curtain and frame - Schweißerschutzwand

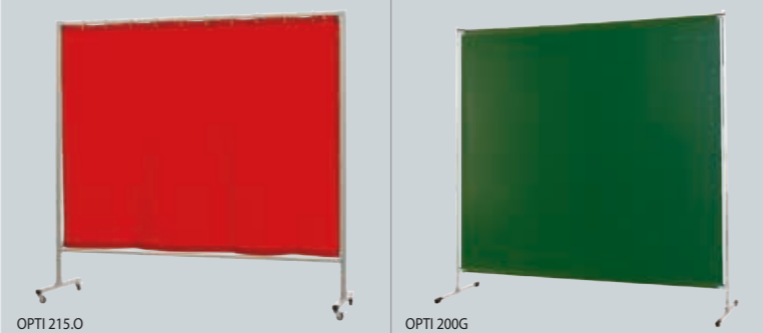

OPTI 215.0
Orange CE - 2 x 2,15 m
EN 25980 - 2015/01
060470

OPTI 200G
Green T9 - 2 x 2 m
EN 25980 - 2015/01
060463

MASQUES RESPIRATOIRES - Respiratory masks - Atemschutzmaske - Máscaras respiratorias

FFP3 - EN 140 / EN 143 / EN 166
(x1) Size M/L
037021

FFP3 - EN 140 / EN 143
(x1) Size M/L
037014

Étui/Case
037045

FFP3 - EN 143 : 2000 P3
Anti poussières / Anti odeurs
037038

FFP1
(x20) EN 149-2001
043916

FFP2D-OV
M/L (x5) EN 149-2001
043923

LUNETTES DE PROTECTION
- Protection goggles - Schutzbrillen

EN 166

Shade/IR0
042810

Shade/IR0
042827

Shade/IR5
042841

Shade/IR0
047778

Shade/IR0
047792

Shade/IR0
042865

Shade/IR0
047839

GANTS - Gloves - Handschuhe - Guantes

Anti coupe - Anti-cut
T9
045897

✓ écran tactile - touch screen friendly

Anti coupe haute résistance
High resistance anti-cut
EN 420
EN 388:4121
T9: 045910
T10: 045927

EN388
4342

Anti coupe haute dextérité
- High dexterity anti-cut
EN 420
EN 388:1121
T9: 045903
T10: 045934

Cuir Leather
T10
064188

EN420
2003

Ultra Flexible
EN388
2003

EN388
4244

EN 407
424X4X
EN12477
Class: A1

Heavy Duty T10
(MMA - MIG - Plasma)
045101

Cuir Leather
Gants PRO TIG
T10
045194

EN388
2122

EN 407
322X2X
EN12477
Class: A1

Cuir Leather
Gants PRO TIG EXTRA
T10
045323

EN388
2111XX

EN 407
423X4X
EN12477
Class: A1

EN388
4244

Gants de soudage renforcés - Reinforced welding gloves
T10
045873

EN 407
424X4X
EN12477
Class: A1

EN388
4244

Gants de soudage renforcés - Reinforced welding gloves
T10
045873

EN 407
424X4X
EN12477
Class: A1

EN388
4244

Gants de soudage renforcés - Reinforced welding gloves
T10
045873

TABLIER CUIR MULTI-USAGE
- Multi-use leather apron - Delantal de cuero multi-uso - Mehrzweck-Lederschürze

Cuir Leather
PRO
045217

ÉQUIPEMENTS POUR OPÉRATIONS SUR VÉHICULES ÉLECTRIQUES & HYBRIDES - Equipment for operations on electric and hybrid vehicles - Ausrüstung für den Betrieb von Elektro- und Hybridfahrzeugen

ÉCRAN FACIAL AVEC SERRE-TÊTE
- FACE SHIELD WITH HEADBAND
068018

NEW

GANTS ISOLANTS (T10)
- INSULATING GLOVES (T10)
068025

NEW

Coffret de 25 outils isolés 1000V - 25 pieces insulated tools 1000V - Box mit 25 isolierten Werkzeugen 1000V
066489

Douilles 7/8/10/12/14/15/17/19/22 mm - 7/8/10/12/14/15/17/19/22 mm sockets	x 9
Pince universelle de 175 mm en chrome vanadium - 175 mm universal pliers in chrome vanadium	x 1
Pince coupante 150 mm en chrome vanadium - Cutting pliers 150 mm in chrome vanadium	x 1
Cluqiet en 3/8" - 3/8" ratchet	x 1
Rallonge 100 mm - Extension 100 mm	x 1
Poignée en T - T-handle	x 1
Clés plates à fourches 7/8/10/12/14/17 mm - Open ended wrenches 7/8/10/12/14/17 mm	x 6
Couteau pour câble - Cable knife	x 1
Tournevis Philips PhH1x100/PhH2x100 mm - Phillips PhH1x100/PhH2x100 mm screwdriver	x 2
Tournevis plats 5.5x125/4x100 mm - Flat screwdriver 5.5x125 / 4x100 mm	x 2



Kit pour le balisage de la zone d'intervention
- Kit for marking the area of intervention
- Kennzeichnungsset für Hochvolt-Bereiche
064409

Balise de signalisation rouge et blanche - Red and white warning pole	x 4
Chaîne de délimitation rouge et blanche - Red and white bounding line	x 1
Pancarte de signalisation "Danger, zone de travail VEH" - Sign board "Danger, working area EHV"	x 2



PANTALON - Trousers - Hose



98% cotton,
2% antistatic

EN ISO 11611
Class 2-A1 & A2

EN ISO 11612
A1+A2-B1-C1-E3-F1

IEC 61482-2
Class 1-4kA

EN 1149-5

EN 14404
+A1
Type 2

S (40/42)
046368

M (44/46)
046375

L (48/50)
046382

XL (52/54)
046399

XXL (56/58)
046412

VESTE - Jacket - Jacke



IEC 61482-2
Class 1-4kA

EN ISO 11612
A1+A2-B1-C1-E3-F1

EN 14404
+A1
Type 2

EN ISO 11611
Class 2-A1 & A2

EN 1149-5

98% cotton, 2% antistatic

S (40/42) 046313

M (44/46) 046320

L (48/50) 046337

XL (52/54) 046344

XXL (56/58) 046351

BSU & CHARGERS

BATTERY SUPPORT UNIT

Homologations Approvals Zulassungen TESLA APPROVED EQUIPMENT

A FULL RANGE FOR ALL NEEDS



NEW



CATALOGUE 2021



CHARGERS
6 - 12 - 24 - 36 - 48 V

STARTERS & CHARGERS
12 - 24 V

BOOSTERS
6 - 12 - 24 V

TESTERS
12 - 24 V

ACCESSORIES
+
MORE



A COMPLETE RANGE

for 200 > 240 V MONO / TRI
50/60 Hz

DÉBOSSÉLAGE - Dent pulling - デントプラー



SOUDURE PAR POINT - Spotwelding - スポット溶接

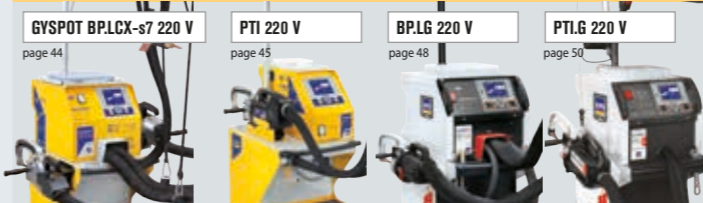

RIVETAGE - Riveting - リベット打ち



MIG/MAG TRADITIONNEL - Traditional MIG/MAG - ミグマグトラディショナル

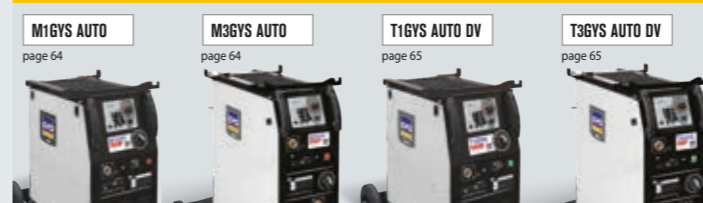

MIG/MAG INVERTER PULSÉ - ミグマグパルスインバーター



CHARGEUR - Battery charger - バッテリーチャージャー



DÉCOUPAGE PLASMA - Plasma cutting - プラズマカッター



INDUCTION - インダクション



INDIAN CAR MANUFACTURER APPROVALS / COMPLIANCE

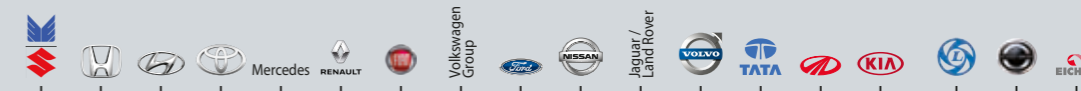

		OEM - CARS										OEM - TRUCKS				
DENT PULLER	GYSPOT 39.02															
	SPEEDLINER															
SPOT WELDERS	GYSPOT ALU FV															
	GYSPOT 32D															
	GYSPOT INVERTER BP-MS/LX/LC/LQC															
MIG/MAG	GYSPOT EVOLUTION PTI-s7															
	CARMIG															
	T1 GYS AUTO															
PLASMA	T3 GYS AUTO															
	NEOPULSE															
INDUCTION	CUTTER 25K															
	CUTTER 30FV															
BATTERY CHARGERS	GYSDUCTION AUTO															
	TOOLS & TROLLEYS															

INDIAN HOMOLOGATIONS

200 - 208 - 230 - 240 V TRI - 50/60 Hz



GYS FRANCE

HEADQUARTER

1 rue de la Croix des Landes
CS 54159
53941 Saint-Berthevin - Cedex
Laval - France
Tel +33 2 43 01 23 60
E-mail service.client@gys.fr



ZI, 134 bd des Loges
53941 Saint-Berthevin
Laval - France

LOGISTIC CENTER

2 Rue Jean Dausset
53910 Changé - France
Tel +33 2 43 01 54 33



INVEST IN THE FUTURE



French manufacturer
since 1964

INVEST IN THE FUTURE

www.gys.fr



GYS Germany

Professor-Wieler
Straße 11
52070 Aachen
Deutschland

Tel +49 241 / 189-23-710
Fax +49 241 / 189-23-719
E-mail aachen@gys.fr



GYS UK

Unit 3
Great Central Way
Rugby - Warwickshire
CV21 3XH
United Kingdom

Tel +44 1926 338 609
Fax +44 1926 429 764
E-mail uk@gys.fr



GYS ITALIA

Vega - Parco Scientifico Tecnologico
di Venezia
Via Delle Industrie, 25/4
30175 Marghera - VE
Italia

Tel +39 041 53 21 565
E-mail italia@gys.fr



GYS CHINA

Lot N°15
6666 bd Songze
201706 Qingpu Shanghai
China

Tel +86 6221 4461
Fax +86 5226 0067
www.gys-china.com.cn
E-mail contact@gys-china.com.cn

MARKETING

Podium de présentation
- Display stand
- Podest

PODIUM 2
A : 80 cm
B : 50 cm
C : 50 cm
063211

PODIUM 1
A : 45 cm
B : 50 cm
C : 50 cm
063204

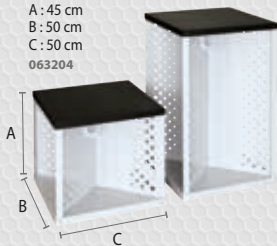

Linéaire de vente avec 2 étagères
- Retail display space with 2 shelves
- Lochwandregal mit 2 Böden
(machines not included)
060784



Barnum 3 x 3 m
098022

Open barnum
2 x 2 m
098039



Oriflamme
- Flag
1,75 x 0,50 m
098015

Distributed by

LinkedIn



Youtube



WeChat



Document non contractuel. GYS se réserve le droit de modifier sans préavis les spécifications de ses appareils.
Document non contractual. GYS reserves the right to modify the specifications of the machines without prior notice.

sstarif 095106

