

A full-page background image showing a worker in a hard hat and safety glasses operating a large industrial plating tank. The tank is filled with a bright orange-red liquid, and the worker is using a long tool to handle a component. The scene is dimly lit, with the primary light source being the glowing liquid in the tank. Several large industrial fans are visible on the wall behind the worker. In the bottom left corner, a green barrel with the text 'VALI PLATING' is partially visible.

**FIND THE
RIGHT TOOLS,
USE THEM
FOR LIFE**

A12000 T&E PRODUCT CATALOG TABLE OF CONTENTS



Cover: Steve Cross,
Drop Forge Operator of 40 years

"I'M PROUD OF THE OTC BRAND. I'M MAKING A BRAND THAT'S BEEN AROUND A LONG TIME. ANY GUY THAT'S WORKED ON A CAR HAS HEARD OF THE OTC BRAND, AND THEY PROBABLY HAVE USED IT."



CUSTOMER SERVICE

Phone: 800-533-6127
Fax: 800-283-8665
Email: inquiry@service-solutions.com

REPAIRS

Service Repair
Phone: 800-344-4013
Fax: 507-455-4318
Email: eservice@service-solutions.com

TECHNICAL SUPPORT

Phone: 800-533-6127
Fax: 800-955-8329
Email: tech@otctools.com

INTERNATIONAL SALES

Phone: 507-455-7223
Fax: 507-455-7063
Email: intl.inquiries@service-solutions.com

MAILING ADDRESS

Bosch Automotive Service Solutions
28635 Mound Road
Warren, MI 48092 USA

PUBLISHER: Alison Accavitti

EDITOR / MEDIA INQUIRIES:
Justin Fiset

DESIGN TEAM: Cameron Payne,
Kimi Blackledge, Milt Taylor

PRODUCT TEAM: Denny Hanson,
Rob Kochie, Dirk Skogerboe,
Marc Rosone

ENGINE & EXHAUST SERVICE	1-20	BATTERY SERVICE	86
FUEL SERVICE	21-32	ELECTRICAL SERVICE	87-90
OIL SERVICE	33-38	A/C SERVICE	91-92
COOLANT SERVICE	39-42	BODY SERVICE	93-102
LUBRICATE/AIR SERVICE	43-44	FASTENER SERVICE	103-108
TRANSMISSION SERVICE	45-49	PLIERS & CUTTERS	109-114
DRIVE AXLE SERVICE	50-54	STRIKE/STRUCK	115-117
STEERING SERVICE	55-60	GENERAL PURPOSE	117-118
SUSPENSION SERVICE	61-67	PULLERS	119-136
HUB SERVICE	68-72	MOTORCYCLE/ POWERSPORT	137-158
BRAKE SERVICE	73-79	HEAVY DUTY TOOLS & EQUIPMENT	159-198
WHEEL & TIRE SERVICE	80-84	SHOP EQUIPMENT	199-234

A PROUD HERITAGE

Since 1925





ENGINE

Ford Engine Tools	2 – 6
GM Engine Tools	7 – 9
Chrysler/Jeep Engine Tools	10
Import Engine Tools	11
Cam Holders / Sets / Flange-Type Puller Sets	12
Harmonic Balancers / Belt tools	13
Serpentine Belts / Pulley Tools	13
Frost Plug Remover/Installer, Piston Ring Compressor Sets	15
Glow Plug Tools / Spark Testers	16
Compression Tester Kits	17
Vacuum / Preluber/ Diesel Compression Tester	18
Double Edge Screw Extractors	19
Drilling Guide System	19
Automatic Center Punch	19
Hose & PVC Cutters	20

EXHAUST

Flexihead O2 Sensor Wrench, Oxygen Sensor Sockets and Sets, Exhaust Back Pressure Gauge	20
--	----

6690
Ford Master Cam Tool Kit

- Contains 40 tools to ensure correct cam timing when servicing timing belts, chains, head gaskets, or other valve train repairs.
- Covers L4, V6, V8, V10 engine with 2V, 3V, 4V valve configurations, model years 1991 – 2014.
- Application guide with diagrams and blow molded case included.



6690-1
Ford Cam Tool Kit Update

- Contains 18 tools, with case locations for addition of the popular 6489 Ford Cam Tools, making a 6690 Kit.
- Ford Cam Tools ensure correct cam timing when servicing timing belts, chains, head gaskets, or other valve train repairs.
- 6690-1 tools cover L4, V6, V8, V10 engines with 3V & 4V valve configurations, model years 2004 – 2014.
- Application guide with diagrams and blow molded case included.



6489
Ford Cam Tool Kit

The OTC Ford cam tools ensure correct cam timing when servicing timing belts, chains, head gaskets, or other valve train repairs.

Ford cam tool kit containing all 22 cam tools covering 1992 thru 2012 for over 50 applications, in a molded storage case.



FOR PRODUCT VIDEOS VISIT
OTCTOOLS.COM



Ford cam tool applications can be found at www.otctools.com by entering the part numbers into the search bar.
Note: Some applications require more than one tool to accomplish the task.

Ford Comparison Chart

Part No.	Description	Similar to Ford	6486A	6487	6488	6489	6498	6680	6681	6682	6683	6690	6690-1
6009	Cam positioning Tool (pair)	303-380		X			X					X	
6020	Cam Positioning Tool	303-413		X			X					X	
6024	Crankshaft Positioning Tool	303-448				X						X	X
6466	Crankshaft Sensor Positioner	303-354					X						
6467	Cam Sensor Sync Tool	303-358					X						
6468	Cam Pulley Holding Tool	303-398					X						
6469	Cam Sensor Sync Tool	303-562					X					X	
6470	Cam Sensor Sync Tool	303-630					X					X	
6471	Cam Sensor Sync Tool	303-453					X						
6472	Cam Sensor Sync Tool	303-529					X					X	
6473	Cam Sensor Sync Tool	303-589					X					X	
6474	Cam Alignment Tool	303-465	X				X					X	
6475	Crankshaft TDC Timing Pin	303-574	X				X					X	
6476	Cam Positioning Tool Set	303-S568		X			X					X	
6477	Cam Holding Tool	303-557		X			X					X	
6478	Cam Gear Holding Tool	303-564			X		X					X	
6479	Crankshaft Holding Tool	303-573			X		X					X	
6480	Cam Holding Tool Adapter	303-576			X		X					X	
6481	Cam Holding Tool	303-577			X		X					X	
6482	Cam Gear Holding Tool Adapter	303-578			X		X					X	
6483	Cam Sensor Sync Tool	303-638					X					X	
6484	Timing Chain Tensioner Tool	303-571			X		X					X	
6485	Cam Gear Bolt Socket & Ext.	303-565, 303-575			X		X					X	
525216	Camshaft Positioning Tool Assy	303-445				X						X	X
525217	Camshaft Holding Tool	303-446				X						X	X
525218	Camshaft Holding Tool	303-1248				X						X	X
7419	Tensioner Retaining Pin Set	none										X	X
567611	Timing Chain Tensioner Assy	303-1532						X				X	X
567613	Crankshaft Alignment Tool	303-645A						X				X	X
567614	Cam Phaser Holding Tool	303-1046							X			X	X
567617	Timing Chain Locking Tool	303-1175							X			X	X
567618	Camshaft Holding Tool	303-1248								X		X	X
567619	Chain Tensioner Hold Down Tool	303-1530								X		X	X
567620	VCT Alignment Tool	303-1097									X	X	X
567621	Camshaft Holding Timing Tool	303-376B									X	X	X
567622	Crankshaft TDC Timing Pin	303-507	X									X	X
567623	Crankshaft TDC Timing Pin	303-748									X	X	X
567649	Camshaft Holding Tool	303-530						X				X	X





6487
Ford Cam Tool Kit

Ford cam tool kit for 1992 thru 2012 4.6L, 5.4L V8, and 6.8L V10 engines. Contains tool Nos. 6476, 6477, 6009, 6020, and molded storage case.



6680
Ford 3.9L 4V Cam Tool Set

The 6680 is designed to service Ford 3.9L 4V V8 engines used in 2000-2006 Lincoln LS cars.



6681
Ford 4.6L, 5.4L, 6.8L 3V Cam Tool Set

- The 6681 is designed to service;
- Ford 4.6L 3V V8 engines used in 05-10 Mustang, 06-10 Explorer, 09 F-Series trucks.
- Ford 5.4L 3V V8 engines used in 04-12 F-Series, 05-10 Expedition, 05-12 Lincoln Navigator.
- Ford 6.8L 3V V10 engines used in 05-12 F-Series 250-350-450.



6488
Ford Cam Tool Kit

Ford cam tool kit for 1997 thru 2011 4.0L Explorer/Mountaineer SOHC V6 engines. Kit contains tool Nos. 6478, 6479, 6480, 6481, 6482, 6484, 6485, and molded storage case.



6682
Ford 3.5L & 3.7L 4V Cam Tool Set

- Ford 3.5L 4V V6 engines used in 07-12 Edge & MKZ, 07-09 MKX, 08-12 Taurus & Taurus X & Sable, 10-12 Fusion, 10-12 MKZ & MKS & MKT, 11-12 Explorer & F150.
- Ford 3.7L 4V V6 engines used in 09-12 MKS, 10-12 MKT, 11-12 Mustang & F150 & MKZ & Edge.



6683
Ford 1.6L 4V Cam Tool Set

- Works on Ford 1.6L 4V L4 engines used in 11-12 Fiesta.



6486A
Ford 2.0L, 2.3L, 2.5L 4V Cam Tool Set

- Ford 2.0L 4V L4 engines used in 94-12 multiple vehicle platforms.
- Ford 2.3L 4V L4 engines used in 05-08 Escape Hybrid, Mariner Hybrid.
- Ford 2.5L 4V L4 engines used in 09-12 Escape & Mariner, 10-12 Fusion & Fusion Hybrid, 11-12 MKZ.



6684
Ford 3V Valve Spring Compressor

- Designed to compress valve springs on a Ford 3V 4.6L & 5.4L.
- Similar to OE p/n 303-1039.

6498
Ford 4.6L & 5.4L 4-Valve Cam Timing Kit

Saves time; all tools required for camshaft timing are in one kit.

Set Includes:

- 525216** – Camshaft positioning tool
- 525217** – Camshaft holding tool
- 6024** – Crankshaft positioning tool
- 525218** – Secondary chain tensioner tool



6024
Ford Crankshaft Positioning Tool

- Designed for use on Ford 1993–2012 4.2L, 4.6L 2-valve, 4.6L 4-valve, 5.4L V8, and 6.8L V10 engines when installing timing chains. These engines are not free wheeling, and if an engine has “jumped time,” it is possible the cylinder heads have to be removed because of damage to the valves or pistons.
- Easily installs over the crankshaft and engine front cover alignment dowel to position the crankshaft at top-dead-center — the correct position for timing chain installation. OTC recommends the No. 6024 be used with Nos. 6009 and 6020 (but it is not required).



Similar to Ford 303-567

7928
Ford Valve Spring Compressor Tool

Compresses valve springs for quicker, easier camshaft, valve seal, valve spring, or retainer service—because you don’t have to remove the head from the engine first! It’s an OEM-approved tool that you use with a 3/8” ratchet or breaker bar. Works on: 1991–2004 Ford vehicles with 4.6L, two-valve, V8 engines; 4.6 4V, 5.4 V8 and 6.8 V10.



**6918
Ford Spark Plug Remover Kit, 3V Engine**

- Unique design helps prevent breakage by locking the plug porcelain core to the plug hex allowing it to turn as one complete unit.
- Will also pull plug porcelain core if plug hex only is removed.
- Detailed Instructions to maximize success rate.

Works on:

- Ford 4.6L 3V V8 engines used in 2005–2008 Mustang, 2006–2008 Explorer.
- Ford 5.4L 3V V8 engines used in 2004–2008 F-Series, 2005–2008 Expedition, 2005–2008 Lincoln Navigator.
- Ford 6.8L 3V V10 engines used in 2005–2008 F-Series 250–350–450.



**6770
Ford 6.0L Diesel Service Tool Kit**

- 8 of our popular 6.0L Diesel Service Tools in one convenient kit.
- Properly test vehicle systems for leaks and blockage.
- Safely remove and re-install harnesses without damage.
- Fuel Filter Cap Wrench, Glow Plug and Injector Harness Release Tools.
- Oil Line Disconnect Tool, EGR Removal Tool.
- IPR Controller, IPR Socket Tool and Fuel Rail Pressure Adapters.



**7483A
Water Pump Puller Remover/Installer**

Helps remove and install water pump pulleys faster and easier on specific Ford, Lincoln and Mercury 3.0L DOHC engines. The puller works on the below vehicles with a Ford 3.0 DOHC engine:

- Ford Escape 2001–2012
- Ford Fusion 2006–2012
- Ford Taurus 2001–2005
- Lincoln MKZ 2007–2012
- Mercury Mariner/Milan 2006–2011
- Mercury Sable 2001–2005



**6900
Ford Spark Plug Socket**

- This unique design works on 2004–newer Ford vehicles with 5.4L, 4.6L, V8, 6.8L, V10, 3-valve engines.
- Socket end is 9/16". Soft rubber insert holds and protects spark plug during removal and installation.
- Extension is part of the socket. Easily fits down spark plug tube in cylinder head.
- Socket has a 3/8" drive for use with a ratchet or breaker bar.



**5607
Compression Tester Ford 14mm Adapter**

Use with OTC compression testers to access hard to reach spark plug holes.

- Works on 2004 and 2007 Ford 4.6 and 5.4 L, V-8, 3 valve engines.
- Easy-to-turn feature makes starting thread fast.
- Use with compression testers with 14 mm thread.



**5608
Compression Tester Ford 12mm Adapter**

Use with OTC compression testers to access hard-to-reach spark plug holes.

- Works on 2008 and newer Ford 4.6, 5.4 and 6.8L 3-valve engines with 12mm spark plugs
- Easy-to-turn feature makes starting thread fast



Similar to Ford 303-S524

**7834
Ford Rear Crankshaft Seal Installer**

- This installer works on crankshaft rear oil seals that come with or without a metal wear sleeve.
- Designed for use on 1993–1997 Aerostar or 1993–2011 Ranger and Explorer with 4.0L V6 engine.



**7835
Ford Rear Main Oil Seal Kit**

- Works on 1994–2003 7.3L diesel engine in Ford 3/4- and 1-ton trucks.
- A complete kit with the tools you need to correctly remove and install the rear main oil seal and wear ring on the crankshaft.
- Eliminates makeshift methods of seal removal and installation that could damage the new seal or crankshaft.



Similar to Ford 303-178 (T82L-6701-A)

**7786
Ford Rear Main Seal Installer**

This installer is the most accurate way to ensure that the rear main seal is set to the correct depth on the crankshaft. The installer fits over the seal, and with the two bolts included, attaches to the engine crankshaft. By alternately tightening the bolts, the seal is pulled into place quickly, easily, and with no damage to the rear main seal. Works on 2.5L 1998–2002 DOHC engines 3.0L 2000–2012 DOHC engines



**7482
EGR Valve Puller**

- Removes EGR valve.
- Fits Ford 6.4L diesel engines, 2008-2010.
- Similar to 303-1267A



**6768
Ford 6.0L Glow
Plug Release Tool**

Safely remove and install the glow plug harness on 2004-2009 Ford 6.0L Diesel engines.



**6076
Ford Diesel Compression Test Adapter**

When the glow plug is removed from the cylinder, this adapter is used to connect the No. 5021 gauge to perform a compression test.

- Works on 1994-2005 Ford vans and pickups with 7.3L direct-injected turbocharged (DIT) diesel engine.



**6660
Compression Tester**

- Use with OTC No. 5021 diesel engine compression gauge.
- Works on 2003-2009 Ford vans and trucks with 6.0L diesel engines.



Similar to Ford No. 303-755

**6594
Ford Oil Line Disconnect Tool for 6.0 L**

- Use to disconnect the high-pressure oil rail supply line from the fuel rail when removing fuel injectors.
- Works on the 6.0: diesel engine found in 2003-2009 F-250, F-350, F-450, F-550 trucks, Excursions and Ford vans.

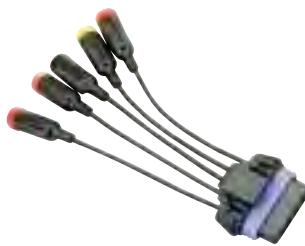

**6088
Ford 5-pin Connector Harness for Glow Plug Testing**

- Provides an easy way to check glow plug resistance without having to remove the valve cover of 1994-98 Ford trucks and vans with 7.3L DIT (direct-injected turbocharged) diesel engines.
- Used with any standard digital volt ohmmeter to check glow plug resistance.



Similar to Ford 303-625

**6595
Ford High Pressure Oil Line Disconnect Tool**

- Use to disconnect the high pressure oil line from the cylinder head.
- Works on 1998 - 2003 Ford vans and trucks with 7.3L direct-injected, turbo-charged (DIT) diesel engines.

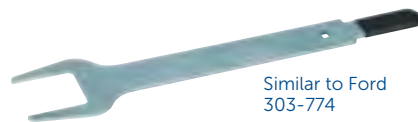

Similar to Ford 303-774

**6974
Ford 6.0L Diesel Fan Clutch Wrench**

- Applications: 2003-2009 Ford F-550 & F-650 Super Duty trucks with the 6.0L diesel engine.
- This is a required tool to tighten or loosen the fan clutch on the water pump.
- Wrench has a 68.45 mm (2-11/16") opening



Similar to Ford 303-591

**6068
Ford Diesel Fan Clutch Wrench**

- Designed for use with OTC No. 7205E1 holding tool to remove fan clutch assembly. Has the same size opening as the OTC No. 7205E2 wrench, but has a special bend in the handle to provide clearance for accessories found on some vehicles.

Application: 1998-2003 Ford vans and pickups with 7.3L direct-injected turbocharged (DIT) diesel engine.



**206391
Ford Engine Adapters**

- 6.0L and 6.4L Ford engine adapters.(Works with both the OTC 1735 and OTC 1735A).



206391 Ford Engine Adapters shown mount on OTC's 1735A sold separately.

GM IN-LINE 4-CYLINDER CAM TOOL SET



6685

GM In-line 4-Cylinder Cam Tool Set

- Comprehensive tool kit designed to save time when servicing GM 4-cylinder engines.

GM cam tool application can be found at www.otctools.com by entering the part numbers into the search bar.

Note: Some applications require more than one tool to accomplish the task.

GM In-line 4-Cylinder Cam Tool Set includes the following:

527045

Camshaft Timing

Alignment Pins

Similar to GM
J-36008A



536172

Camshaft

Holding Tool

Similar to GM
J-44221



536186

Timing Chain

Holder

Similar to GM
J-44217-1



527046

Camshaft

Sprocket Wrench

Similar to GM
J-36013



6675 (536173)

Timing Belt

Adjuster

Similar to GM
J-42492A



536187

Timing Chain

Holder

Similar to GM
J44217-2



527049

Camshaft

Sprocket Wrench

Similar to GM
J-39579



536174

Camshaft Gear

Holder

Similar to GM
J-43299



536254

Camshaft Timing

Alignment Pin



527056

Camshaft Sprocket

Holding Tool

Similar to GM
J-43655



536176

Camshaft Gear

Holder

Similar to GM
J-43299



536255

Timing Chain

Tensioner Retainer



532174

Timing Chain

Tensioner & Shoe

Retainer



536178

Crankshaft Pulley

Holder

Similar to GM
J-38122



536265

Timing Chain

Holder

Similar to GM
J-44217-46



532195

Timing Chain

Tensioner Retainer

Similar to GM
J-36589



536181

Camshaft Sprocket

Holding Tool

Similar to GM
J-44222



527061-1

Timing Chain

Tensioner

Loading Tool

Similar to GM
J-45027



527061-2

Timing Chain

Tensioner Loading

Tool

Similar to GM
J-45027



**FOR MORE DETAILS VISIT
OTCTOOLS.COM**



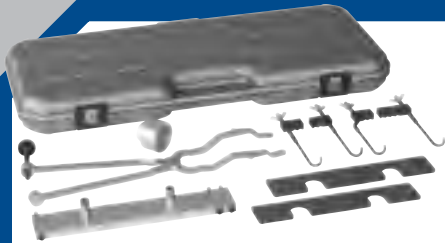

6686
GM NorthStar V8 Cam Tool Set

- Kit is indispensable for quickly and correctly servicing GM NorthStar 4.0L and 4.6L V8 engines.

Set Includes:

- 527048** Cam Chain Tension Holder
- 527050** Crankshaft Rotation Tool
- 527057** Camshaft Holding Tool (qty. 2)
- 527058** Secondary Drive Sprocket Fixture
- 529636** Timing Chain Retention Tool
- 529637** Timing Chain Retention Tool
- 529638** Timing Chain Retention Tool (qty. 2)



6687
GM 6 Cylinder Cam Tool Set

- Required tools to adjust and hold cam shaft timing on GM 3.0 and 3.2 V-6 engines.
- Kit is designed to save shop time when servicing GM 3.0 and 3.2 V-6 engines.

Set Includes:

- 536594** Camshaft Locking Tool
- 536595** Camshaft Locking Tool
- 536596** Crankshaft Holding Tool
- 536608** Camshaft Alignment Gauge
- 536611** Timing Belt Installation Tool
- 536612** Timing Belt Tensioner Wrench
- 536613** Crankshaft Socket



6744
Tensioner Retaining Pin

- Relieves the tension on the timing chain tensioner for camshaft, actuator, and timing chain service. Engages the tensioner arm and moves it forward to disengage the ratchet mechanism. Similar to EN-50837.
- Applications: 2013-14 Cadillac ATS, 2014 Cadillac CTS, 2013-14 Chevrolet Malibu, 2014 Chevrolet Impala & Buick Regal 2.0L and 2.5L engines.



6688
GM In-line 5, 6, or V6 Cam Tool Set

- Comprehensive tool kit designed to save time when servicing GM 5-, 6-cylinder engines.
- Tools are actually easier to use than the original OE essential tools.

Set Includes:

- 527051** Camshaft Holding Tool
- 527052** Cam Gear Holding Tool
- 527055** Crankshaft Socket
- 527061-1** Timing Belt Tensioner Loading Tool
- 536172** Camshaft Holding Tool
- 536186** Timing Chain Retention Tool
- 536187** Timing Chain Retention Tool
- 536582** Timing Belt Tensioner Pulley Retaining Tool

6060A
GM Water Pump Socket

- Works on 1993–newer Cadillac 4.6L V8 Northstar engine, and 1995–1999 Oldsmobile Aurora 4.0L V8.
- 1/2" sq. drive for use with 1/2" drive breaker bar or ratchet.
- Tool is designed to self-center in the water pump housing, allowing the tangs to fully engage the water pump for removal or installation.



Similar to J-38816A



6746
Timing Chain Holding Tool

- This holding tool retains the timing chain position relative to the crankshaft position. The tool clamps around the timing chain pins on both the intake and exhaust sides of the cylinder head, allowing the cams to be serviced. Similar to EN-50656.
- Applications: 2013-14 Cadillac ATS, 2014 Cadillac CTS, 2013-14 Chevrolet Malibu, 2014 Chevrolet Impala & Buick Regal 2.0L and 2.5L engines.



GM Crankshaft Balancer Puller Kit and Adapter Set

Everything you need to pull harmonic balancers having three tapped holes. The shoulder bolts are designed to prevent them from being installed too deeply, protecting the crank sensor and/or interrupter rings from damage. The spacer adapter gives the puller's forcing screw something to push against. The kit works on 1990–2002 3300 and 3800 V6 engines. The No. 7911 adapter set consists of the spacer adapter and shoulder bolts only, for use with your No. 518 or No. 6930 flange-type puller.

7911 GM crankshaft balancer puller adapter set. Includes shoulder bolts and spacer adapter only.

7912 GM crankshaft balancer puller kit. Includes No. 518 flange-type puller and No. 7911 adapter set.



Similar to J-43651

6616
GM Water Pump Holding Tool

- Holds timing chain in place so water pump can be removed for service.
- Special design allows easy installation regardless of timing chain orientation.
- Simply remove access plate from front cover and install the tool.
- Tool saves costly loss of timing on 2002–2009 GM 2.2L and 2.4L EcoTech engines.



GM Duramax Injector Pullers

- Designed to pull injectors on a GM Duramax 6.6L engines.

6778 From 2001 - 2004, Similar to J-44639.

6779 From 2005 - 2011, Similar to J-46594.

6754
Diesel Fuel Pressure Gauge

- Designed to test fuel pressure on GM Duramax diesel engines.
- Similar to J-44638.





6758
Front Crank Seal Installer

- Installs the front crank seal with the cover on or off the engine. The bolt is threaded into the crankshaft and the nut is tightened to seat the seal. Similar to EN-50820 & EN48034.
- Applications: 2013-14 Cadillac ATS, 2014 Cadillac CTS, 2013-14 Chevrolet Malibu, 2014 Chevrolet Impala and Buick Regal 2.0L and 2.5L engines.



6788
Pan Seal Cutter

Designed to separate oil pan seals, the cutter is pressed into the sealant and struck with a hammer to cut through the oil pan seals. Other methods may damage the oil pan and/or sealing surfaces. Similar to J-37228. Works on most vehicles.



6553
Connecting Rod Guides

- Set of two connecting rod guides protect the crankshaft bearing surface from damage during piston and connecting rod removal or installation. Guides install onto the connecting rod after the cap is removed and help prevent nicking or scratching. Similar to EN-51454.
- Applications: For use on rods with M8 X 1.0 threads.



6668
Harmonic Balancer Puller Kit

A combination puller kit for GM, Ford, and Chrysler. Includes the coverage of the 7912 and 6667 harmonic balancer puller kits.



6677
Timing Chain Retainer

The tools retain the timing chain and lower sprocket positions while servicing the upper sprockets, camshafts, valve springs, or valve seals on 2011 and later 2.0L and 2.4L Ecotec engines. The tool has two toothed feet that engage the chain and hold it against the guides to retain tension as the tensioner and upper guide bolt are removed. Also used for cylinder head replacement. Similar to EN-48749.



6691
Camshaft Retaining Tool

Oversized retaining plates lock camshafts together at top dead center (TDC) on GM 2.8L 3.0L and 3.6L DOHC engines. Three-plate set is used to tighten both sets of cams to prevent them from turning while setting timing. Extra-large size prevents valve covers from being installed with the plates in place, protecting the engine. Similar to EN-48383.



6706
Injector Rail Assembly Remover

- Used for removal of the direct injection fuel rail without damage. The rail assembly must be removed as straight as possible to prevent damaging an injector bore in the cylinder head or the mount assembly.
- Similar to EN-49248.
- Applications: 2007-2014 General Motors Direct Injection Engines including those used in Pontiac, Saturn, Cadillac and Chevrolet vehicles.



6745
Camshaft Actuator Locking Tool

This locking tool engages the slots in the face of the actuator and bolts to the cylinder head and cover to hold the actuator in position to remove or install the actuator bolt. Similar to EN-50793. Applications: 2013-14 Cadillac ATS, 2014 Cadillac CTS, 2013-14 Chevrolet Malibu, 2014 Chevrolet Impala & Buick Regal 2.0L, 2.5L engines.



6689 Chrysler/Jeep Cam Tool Set

The Chrysler/Jeep cam timing tools are provided to ensure correct cam timing when servicing timing belts, chains, head gaskets, or performing other valve train repairs. These 15 tools are based on OE designs and are offered to service the following applications: Cam positioning is an important procedure. If cam timing is not correct, the engine may still run, but emissions and mileage will be affected. The engine computer may also initiate the "Check Engine" light.

Set Includes:

- 513990** Crankshaft Damper Puller
- 522888** Camshaft Alignment Tools
- 522889** Camshaft Sprocket Holder
- 522890** Timing Chain Tensioner Reset Tool
- 522891** Harmonic Balancer Holding Ring
- 522892** Timing Chain Wedge
- 522893** Timing Chain Wedge
- 522894** Camshaft Wrench
- 522896** Idler Shaft Remover
- 522897** Tensioner Lock Pin
- 522898** Camshaft Holding Pins
- 522899** Timing Belt Tensioner
- 522900A** Timing Belt Tensioner Tool
- 522901** Timing Belt Wrench
- 522902** Secondary Timing Chain Holder



7222 Injector Tube Remover/Installer

- Removes injector tubes for service and re-installs.
- Fits GM 6.6L Duramax Diesel, 2001 to present.
- Similar to J-45910.



7223 Glow Plug Bore Reamer

- Reams glow plug bores for proper replacement of glow plugs.
- Fits GM 6.6L Duramax Diesel, 2001 to present.
- Similar to EN-51249.



6075 Chrysler Crankshaft Damper Remover/Installer Kit

3-jaw puller is used with the insert to remove the crankshaft damper whenever timing belt, water pump, or front cover service is required. The tool kit includes a damper installing tool with bearing.

- Services Chrysler-built 2.0L, 2.4L, 2.5L, 3.3L and 3.5L engines.
- 1995–2010 3.3L and 3.5L V6 used in Chrysler New Yorker and Concorde, Dodge Intrepid, and Eagle Vision; 1995–newer 2.0L, 2.4L 4-cyl., and 2.5L V6 used in Cirrus, Stratus, and Breeze; 1995–newer 2.0L 4-cyl. used in Neon.



Similar to Miller No. 6642

7999 Chrysler Camshaft Alignment Tool Set

These special brackets are necessary to ensure exact alignment of the camshaft sprockets during timing belt installation on all 1993–2010 vehicles with a 3.5L OHC engine.



6495 Chrysler Harmonic Balancer Holding Tool

- Designed as a holding ring with three pins to fit into the openings on a harmonic balancer.
- Use with a 1/2" ratchet or breaker bar to hold the harmonic balancer in place when turning the bolt that holds the balancer to the crankshaft. Also use to hold the balancer when removing it from the engine.
- Works on 1990–2010 3.3L V6 vans; 1994–2011 3.8L V6; 1993–1997 3.3L and 3.5L V6 cars; 1998–newer 2.7L, 3.2L, and 3.5L V6 cars.



Similar to Miller No. C-3053

6293 Distributor Bushing Installer/Reamer

- Used to install the distributor drive shaft lower bushing into the engine block. Then use this same tool to ream the new bushing so the distributor drive shaft correctly fits into the bushing.
- Works on Chrysler, Dodge, and Plymouth 3.9L V6, 5.2L & 5.9L V8 vehicles with distributors.
- Compatible with OEM and aftermarket distributor drive bushings.



6667 Harmonic Balancer Puller

Designed for removing damper pulleys in tight engine compartments, without removing the radiator. Use on the following:

- GM 2000 Generation III 4.8L, 5.3L, 5.7L 6.0L, and 8.1L V8s. Also works on Cadillac 4.5, 4.6, and 4.9L V8s beginning in 1988. Chevrolet trucks 2003–later 4.2L I6, 2004–current 3.5L I5 & 2005–current 2.8L I4.
- Chrysler engines from 1990–later, including 2.0L, 2.4L-cyl; plus 2.5L, 2.7L, 3.3L, 3.5L, and 3.8L V6s.
- Ford 1995–later V8 engines with 3 spoke pressed on damper.
- Mitsubishi Eclipse 1995–1999 2.0L DOHC non-turbo.
- Kit contains the 3-jaw puller, four lengths of forcing rods, and a forcing screw with a 3/8" square drive for ratchet use, and a 3/4" hex for wrench or socket use.

Replacement rods:

- 537757-4** 5/16" x 4"
- 537757-5** 5/16" x 5-13/32"
- 537757-6** 5/16" x 6-1/2"
- 537757-7** 5/16" x 7.13/32"



6284 Harmonic Balancer Puller Set

- Includes No. 6667 puller, which removes the harmonic balancer from the crankshaft; and No. 6495 holding tool, which holds the harmonic balancer when tightening or loosening the crankshaft bolt, or removing the balancer.



Similar to Miller MD-998767

7997 Chrysler Timing Belt Wrench

Correctly adjusts the timing belt tension on 1991–1994 3.0L DOHC Dodge Stealth, 1992–1994 Eagle Summit, 1992–1994 Dodge Colt, and 1984–1991 2.0L Dodge Colt. For use with a 1/4" drive ratchet.



4731A

Honda/Acura Dampner Holding Tool

- Holds dampner for removal/installation of the crank bolt on Honda/Acura engines.
- 4" offset.
- 1/2" square drive can be used with ratchet or breaker bar.
- 50mm hex with large center hole.
- Will fit around accessories eliminating additional part removal.
- Proper fit for applications and allows use of impact tool to remove bolt.

Works on:

Honda – Accord, Civic, CRV, Del Sol, Element, Fit, Insight, Odyssey, Pilot, Prelude, Ridgeline, S2000. Acura – CL, Integra, Legend, MDX, RL, RSX, TL, TSX.



7447

Cover Alignment Tool

- Aligns front and rear timing chain/crank seal cover.
- Fits GM 4.8L, 5.3L, 5.7L, 6.0L engines, 1996-Present.
- Similar to J-41476.



7481

Supply Tube Removal Tool

- Removes high pressure fuel supply tube.
- Fits Ford 6.0L diesel engines, 2003-2010.
- Similar to 303-1164.



6742

Crankshaft Seal Installer

Installs front crankshaft seal on 2012-2013 Chevrolet Sonic, 2012 Aveo, 2011-2012 Cruze, 2011-2012 Volt. Similar to KM-960.



4732

Honda/Acura Crankshaft and Harmonic Balancer Holder

- Allows the crankshaft pulley and/or harmonic balancer bolt to break loose.
- Includes tool necessary to properly counter the rotation of the crankshaft pulley/harmonic balancer during removal and reinstallation of crank bolt.
- Secures the pulley in place not allowing it to rotate during removal and reinstallation of crank bolt.



7219

Oil Pressure Adapter

- Allows for engine oil pressure to be measured.
- Installs in place of oil filter providing ports to attach oil pressure tester.
- Dual port for bottom or side tester connection.
- Installs with 11/16" (17mm) hex drive socket.
- Fits GM 4.8L, 5.3L, 5.7L, 6.0L engines, 1996-Present.
- Similar to J-42907.



6613

Variable Pin Spanner Wrench

- Universal design fits many different types of pulleys having slots or holes, including camshaft pulleys and crankshaft pulleys.
- Wrench is adjustable from 1-1/4 inch to 5 inches; works with a 1/2 inch ratchet or breaker bar.

Set Includes:

526908-1	3.5 mm pin	526908-5	6 mm pin
526908-2	4 mm pin	526908-6	7 mm pin
526908-3	4.5 mm pin	526908-7	10 mm pin
526908-4	5 mm pin	526908-8	Handle



5940

BMW Head Bolt Socket

- Socket is designed to fit in the cylinder head on M42 and M50 engines to remove and install cylinder head bolts.
- Spring loaded detent ball holds bolt in place.
- Works with 1/2 inch ratchet, breaker bar, or torque wrench. Socket size is E12 for external TORX® bolts.



Similar to Toyota No. 09043-50080

6022

Toyota Head Bolt Socket

- Specially designed socket is needed to tighten or loosen head bolts on Toyota Paseo vehicles with 3S-GE and 3S-FE engines.
- 8 mm socket features a 12-point, 1/2 inch drive socket.



Mirror Finish

6985

Mercedes-Benz and BMW Fan Clutch Service Kit

- Mercedes-Benz fan clutch holding wrench holds the water pump pulley to allow release of the fan.
- BMW Fan clutch holding wrench holds the water pump pulley in place while loosening the radiator fan. Works on BMW M10, M20, M30, & other late model vehicles. (Holes at 38 mm & 44.5 mm.)
- Mercedes-Benz fan clutch wrench removes the thermo-viscous radiator fans found on Mercedes-Benz vehicles. Works on M-B engines: M111, OM604, OM605, and OM606 (C & E Class; 36 mm opening).
- Mercedes-Benz fan clutch wrench is used to remove or install the fan clutch assembly. Slim shaft handle lets you easily work in tight spaces. Works on M-B engines: M103, M104, M119, and M120 (65 mm opening).
- BMW fan clutch wrench is used to remove and install the thermo-viscous fan on BMWs and Fords (32 mm opening).
- Mercedes-Benz Fan Clutch Holding Tool is used to remove / replace thermo-viscous fan coupling with the radiator in place.
- Universal fan belt adjustment wrench services Mercedes-Benz, Nissan Quest, and Mercury Villager radiator fans and pulley belts. It also can be used for loosening the A/C idler pulley tensioner lock nuts for A/C belt adjustment or replacement. Also contains 2.5 mm, 8 mm, and 10 mm Allen keys.



**7196
Crank & Cam Seal Service Kit**

- Removes and installs camshaft and crankshaft seals on cars, trucks, vans and SUVs without damage.
- Includes a puller coupled with specialized puller legs that hook the seal for quick and easy removal.
- The interchangeable seal install adapters are designed for use with the cam or crank bolt. Kit services seal sizes of 21.5mm to 64mm.



**6678
Cam Gear Holder, 2 pack**

- The holders clamp between the engine block or head and the back of the gear to lock it in place.
- Use on single, dual, or quad cam engines to hold valve timing during belt replacement.
- Excellent for diesel injection pump belt replacement.
- The cam gear holders universal design are quick and easy to install.



**6679
Cam Gear Clamp & Holder Set**

- The holders clamp between the engine block or head and the back of the gear to lock it in place. The cam gear clamp is used between two adjacent gears to lock them together and eliminate movement.
- Use on single, dual, or quad cam engines to hold valve timing during belt replacement.
- Excellent for diesel injection pump belt replacement.



**7790
Flange-Type Puller Set (Grade 5)**

- Versatile puller capable of removing a wide variety of components having tapped pulling holes, including harmonic balancers, gears, crankshaft pulleys, etc.
- Capable of handling 2- or 3-way bolt pulling applications.
- Works on many cars, pickups, SUVs, and small engines.
- Carries the OTC Lifetime Warranty® against defects in workmanship and material.

Contents of set:

- Puller flange: adapts to bolt circle dia. of 1-1/2" to 4-5/8".
- Forcing screw: 5-5/8" lg., 5/8-18 thread.
- Shaft protector: 1-3/16" dia. x 3/4" thick.
- Three each of the following flat washers: 1/4"; 5/16"; 3/8".
- Three each of the following bolt sizes:

1/4"-28 x 3" lg.	3/8"-16 x 3" lg.
5/16"-24 x 3" lg.	3/8"-16 x 4-1/2" lg.
5/16"-18 x 3-1/2" lg.	M8 x 1.25 x 45 mm lg.
5/16"-18 x 6" lg.	M8 x 1.25 x 65 mm lg.
3/8"-24 x 1-1/2" lg.	M8 x 1.25 x 90 mm lg.
3/8"-16 x 2" lg.	M10 x 1.5 x 35 mm lg.



**6930
Flange-Type Puller Combination**

- Heavy-duty flange puller features a live center forcing screw. Includes two live center forcing screw tips and two sets of commonly used automotive bolts. Puller will work on bolt circles from 1-1/2" to 4-1/4". Three cap screws, 3/8"-24 x 3" long, and three cap screws, 3/8"-16 x 3" long.



**7793
Master Bolt Grip Set (Grade 8)**

- Multi-Purpose applications such as steering wheels, flywheels, harmonic balancers, pulleys and gears with tapped holes.
- Includes special stepped bolts for 1990-2005 GM 3300-3800 V6 crankshaft pulleys.

Contents of set:

- 4-way slotted puller yoke and 2 lengths of hardened "live-center" forcing screws - a set of 3 interchangeable forcing screw tips is included to optimize pressure and prevent "walking".
- Blow molded case to prevent spilling and each bolt size is molded into the storage compartment.
- Three each of the following bolt sizes:

M8 x 1.25 x 90mm	3/8"-24 UNF x 1.5"
M8 x 1.25 x 45mm	3/8"-16 UNC x 2"
1/4"-28 UNF x 3"	3/8"-16 UNC x 3"
M8 x 1.25 x 65mm	3/8"-16 UNC x 4.5"
5/16"-24 UNF x 3"	M10 x 1.5 x 35mm
5/16"-18 UNC x 3.5"	
- Special Stepped Bolts - 1990 & Newer



**525
Flange-Type Puller Combination**

- Two specialty pullers in one box. You get a flange-type puller for removal of harmonic balancers, timing gears, and other parts with two or three tapped holes. You also get a steering wheel, pulley, and flywheel puller. 525 includes: flange-type puller and steering wheel puller with four sets of cap screws.



6505

Master Harmonic Balancer Installer

- 13 special adapters make this a complete master harmonic balancer installer set for most car and light truck applications.
- The heavy-duty 7/8" diameter forcing screw has internal threads to fit the threaded adapters.
- Plastic storage tray keeps set components organized for easy selection.



4531

Harmonic Balancer Puller/Installer Set

- For easy removal and installation of most harmonic balancers and drive pulleys which are press-fitted onto the crank-shaft.
- A bearing-centered circular 2/3-way puller flange handles 2-1/2" – 4-1/4" bolt circles. An assortment of metric and fractional bolts and adapters provide wide pulling coverage.
- A heavy-duty, 3/4" dia. forcing screw is internally threaded to fit the eight adapters to install harmonic balancers. Adapter sizes included: M16 x 2.0, M14 x 1.5, M12 x 1.5, 1/2"-20, 7/16"-20, 3/4"-16, 5/8"-18, and 9/16"-18.
- A blow-molded plastic storage case keeps set contents organized and protected from loss.



7654A

Serpentine Belt Installation Tool

- Durable tool provides extra control and reach during serpentine belt installation.
- Works equally well on V-belts and timing belts.
- Three-pin design for immediate push/pull capacity.
- Handle gives technician twisting control to install belts in confined, hard-to-reach areas.



4645

Serpentine Belt Tool

- Fits tensioner pulleys with 13 mm–16 mm, 18 mm hex or 3/8" and 1/2" square drives.
- For hard to access tensioners; there are 13 mm and 15 mm 12-point wrenches built into the handle.
- 13 mm, 14 mm and 15 mm crows foot wrenches also included.



7471A

Cummins Engine Barring Tool

- Need to manually rotate an engine? This tool makes the job easy. Just insert the tool into the flywheel housing until it engages the ring gear, then attach a 1/2" square drive ratchet or breaker bar and turn. The tool's load-bearing collar provides friction-free operation while rotating the tool in the housing.
- Works on Cummins B and C series diesel engines and 5.9L liter diesels used in Dodge pickups.



7161

Cummins Engine Turning Tool

This tool makes easy work of manually rotating a Cummins 855 cubic inch engine. It's essential hardware when you're bringing pistons to top dead center to adjust injector timing.



7425

Stretch Belt Service Set

The Stretch Belt Service Set includes an install tool along with a removal tool. Both tools are placed on a pulley which is turned to slip-on or slip-off stretch fit belts without damage.



7424

Belt Holding Tool

- Keeps belt from falling off of a pulley during belt installation.
- Universal design to fit most pulley styles and sizes.
- Super strong magnet to hold the belt firmly on the pulley.
- Multiple holders can be used for belt applications that fit around many pulleys.
- Durable plastic housing with magnet for steel/iron pulley applications.



FOR MORE DETAILS VISIT
OTCTOOLS.COM

CLUTCH, PULLEY AND FLYWHEEL SERVICE



**7419
Timing Tensioner Locking Pin Set**

- This pin set is used to lock timing belt or chain tensioners once they have been compressed, required during the service procedure.
- Once the belt or chain service is complete, the pin is simply pulled out to return the tensioner to functional.
- 6 pin set with clip to cover most all applications.



**6673
Universal Belt Tension Gauge**

- Belt tension gauges are used to check drive belt tension on drive belts to ensure maximum belt and bearing life.
- Scale reads 30–180 lbs.



**4652
Adjustable Fan Clutch Holding Tool**

- Adjustable jaws fit various water pump pulley bolt patterns.
- Jaws adjust from 1/2" to 8-5/16" opening.
- Jaws lock in place to securely hold water pump bolts.
- Long handle offers leverage for extra torque.



**4475
Grooved Pulley Strap Wrench**

- Use to hold a grooved pulley when servicing alternators, water pumps, power steering pumps, etc. Also may be used to rotate the camshaft or crankshaft for engine service.
- Holds tighter than a standard strap wrench.



**7403
Steering Wheel, Pulley, and Flywheel Puller**

- Here's a puller that works in a variety of applications. It pulls steering wheels on most late model cars. It also works as a regular 2/3-way puller to remove pulleys and small engine flywheels. Cap screws included (pairs): 3/8-16 x 3-1/2 in.; 5/16-18 x 3-1/2 in.; 5/16-24 x 3-1/2 in.; M8-1.25 x 90 mm; and 5/16-18 x 4 in. (SIR).
- Works on domestic cars with or without collapsible steering columns.



**4754
Universal Pulley Holder**

- Universal design fits many different size pulleys having slots or holes, such as camshaft pulleys or crankshaft pulleys.
- Wrench is adjustable from 1-1/2" to 8-5/8"; four different size step pins are interchangeable.
- Long handle enables technician to easily hold the pulley when tightening or loosening retaining bolts.



**6617
Alternator Pulley Service Kit**

- Overrunning alternator pulley and overrunning alternator decoupler pulley are designed to extend belt life and belt tensioner life. They also make for quieter and smoother accessory drive operation and reduce vibrations in the passenger compartment.
- These tools hold the alternator shaft still so the pulley can be removed or installed.
- A great time saving tool for the technician and the ability to provide a cost saving service for the vehicle owner.

Kit contains:

- | | |
|-------------------------|----------------------------------|
| Decoupler tool assembly | 28 mm / 21 mm hex cap nut driver |
| 17 mm hex drive | 28 mm / 18 mm hex cap nut driver |
| 17 mm Allen wrench | 22 mm hex cap nut driver |
| 110 mm socket extension | |



4603
Frost Plug Remover/Installer Set

- Designed to remove and install frost plugs used in liquid-cooled gas and diesel engines found in cars, trucks, SUVs, agricultural equipment, and construction equipment.
- Simply use a hammer with the driver and appropriate disc to install frost plugs ranging from 1" to 2-3/8" in diameter.

Set contains:

- 4603-1** Installer Handle (18" lg.)
- 4603-2** Frost Plug Remover
- 4603-3** Frost Plug Disc Set (7 ea., plus 1 retaining nut)



4604
Frost Plug Installer Set

- Designed to install frost plugs in liquid-cooled gas and diesel engines found in automobiles, trucks, SUVs, agricultural equipment, and construction equipment.
- Simply use an air hammer with the driver and appropriate disc to install frost plugs ranging from 1" to 2-1/16" in diameter.
- Adapter sizes; 1.24"OD x 0.87" step, 1.48"OD x 1.30" step, 1.81"OD x 1.55" step.

Set contains:

- 4604-1** Driver (14" lg.)
- 4604-2** Frost Plug Disc Set (3 qty.).



4839
Adjustable Piston Ring Expander Pliers

These simple pliers include tips designed to capture the ends of piston rings to hold and expand them securely while installing onto pistons.

4838
Piston Ring Compressor Set, 6 Piece

This 6 ring set covers 2 7/8" thru 4 3/8" piston diameters. The ring compressor pliers feature a ratcheting lock to hold the handles in position for easy piston installation.



4842
Heavy Duty Valve Spring Compressor

Used to compress valve springs for removal or installation. The heavy duty C-frame has a 9" opening and a 5" throat. Kit includes 16mm, 19mm, 23mm, 25mm, and 30mm valve spring retainer adapters.



4572
Valve Spring Compressor

- Designed to compress valve springs on overhead valve engines.
- Includes two valve spring adapters, which fit valve spring retainers up to 1" (25 mm) and 1-3/16" (30 mm).
- Unique, direct action compressor lever gives better visibility of valve spring retainers located in difficult access areas.
- Jaw opening of 1-3/8" to 5-5/8" (35 mm to 142 mm); throat clearance of 5-7/8" (150 mm).

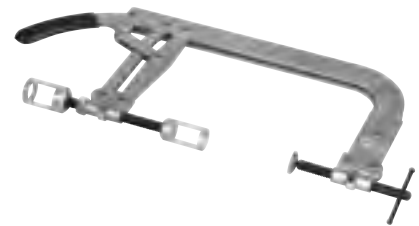

4840
Piston Ring Compressor Set with Ring Expander

This complete set includes 12 chrome plated compressor sleeves covering 1 3/8" thru 4 3/8" diameter piston applications. Both the ring compressor and ring expander pliers feature a ratcheting lock to hold the handles in position for easy piston and ring installation. Complete with a metal carry case.





**4573
Universal Overhead Valve Spring Compressor**

- Permits removal and installation of valve springs without removing the cylinder head on many cars and light trucks. Durable steel construction.
- Spring loaded offset jaws easily grip and compress valve springs.



**6589
Electronic Ignition Spark Tester**

- Check for spark on gasoline engines used in import and domestic cars and trucks, plus small engines.



Similar to Ford 303-567

**7928
Ford Valve Spring Compressor Tool**

Compresses valve springs for quicker, easier camshaft, valve seal, valve spring, or retainer service—because you don't have to remove the head from the engine first! It's an OEM-approved tool that you use with a 3/8" ratchet or breaker bar. Works on: 1991–2004 Ford vehicles with 4.6L, two-valve, V8 engines; 4.6 4V, 5.4 V8 and 6.8 V10.



**5603
Compression Tester - Deep Well Connector**

- Use with OTC compression testers or other compression testers.
- Solid steel 8" length shaft.
- Upper t-wing grip for ease of installation and removal.
- Popular 14 mm thread for both flat and tapered seat plugs.
- Corrosion resistant nickel plated finish.



**6005A
Glow Plug Remover**

Set includes 10 mm and 12 mm split nuts, three spacers (3/16", 1/4", and 5/16"), plastic storage/organizer case and instructions. The 10 mm split nut will work on Ford 6.9L and 7.3L diesels; GM 6.2L, and 6.5L diesels; and various diesels in import vehicles. The 12 mm split nut works on various diesels in import vehicles, plus many agricultural and construction diesel applications.



**4550
Scraper Set**

- Scrapers feature polished, heat-treated, stiff, stainless steel blades. Handles are ergonomic two-component plastic and feature a non-slip grip and steel bolstered end.
- Packaged in a storage tray. Includes: 1-1/4" straight blade, 1-1/4" bent blade, and 2" straight blade.

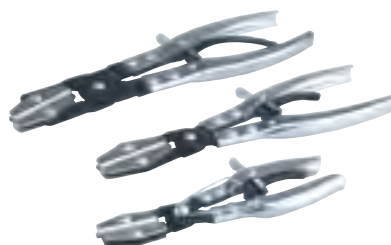

**4510
Hose Pinch Off Pliers Set, 3 Piece**

- Shuts off flow through vacuum lines, fuel lines, coolant lines, etc.
- Cocking ratchet mechanism holds pivoting jaws tightly in place. Heavy-duty swivel jaws pivot to assure parallel pinching.



**4522
Vacuum Hose and Fuel Line Removal Tool**

- Designed to remove vacuum hose or fuel lines (3/16" to 1/2") from fittings or tubing.
- Simply place the black jaw on the fitting or tubing – the jaw will grip the material. Then use the silver jaw to push the vacuum hose or fuel line off the fitting or tube.



5606
Compression Tester Kit

Designed for complete compression testing on gasoline engines, including domestic, imports, motorcycles, marine, and small engines. Unique problem solving features for today's limited space engine compartments.

Features and benefits:

- Corrosion resistant nickel plated finish.
- Adapters work on both flat and tapered seat plugs.
- Extra long 25" flex hose gauge assembly with quick coupler, allows easy viewing out of cluttered engine compartment.
- 2-1/2" gauge features chrome bezel and rugged protective outer boot.
- Dual scale gauge reads 0-300 psi and 0-2100 kPa.
- 12" flex-14 mm standard reach.
- 12" flex-14 mm long reach.
- 10 mm, 12 mm, and 18 mm thread adapters.
- Rugged blow molded hard case with removable lid.
- Repair parts kit.



5605
Deluxe Compression Tester Kit

Complete with standard and specialty adapters, this deluxe kit offers a complete package for compression testing on gasoline engines. Kit includes the deep well connector used on recessed plug well style heads and the Ford engine adapter using 16 mm thread plugs.

Features and benefits:

- Corrosion resistant nickel plated finish.
- Adapters work on both flat and tapered seat plugs.
- Extra long 25" flex hose gauge assembly with quick coupler, allows easy viewing out of cluttered engine compartment.
- 2-1/2" gauge features chrome bezel and rugged protective outer boot.
- Dual scale gauge reads 0-300 psi and 0-2100 kPa.
- 8" deep well 14 mm connector.
- 5" flex Ford 16mm adapter.
- 12" flex-14 mm standard reach.
- 12" flex-14 mm long reach.
- 10 mm, 12mm, and 18 mm thread adapters.
- Rugged blow molded hard case with removable lid.
- Repair parts kit.



5609
Cylinder Leakage Tester Kit

Quickly diagnose internal engine problems such as bad rings, valves and leaking head gaskets. Kit come complete with adapters for most applications.

Features and benefits:

- Dual 2-1/2" gauges feature chrome bezel and rugged protective outer boot.
- Scales read 0-100 psi and 0-700 kPa.
- Pressure regulated manifold includes quick couplers.
- Long flex 24" 14 mm hose.
- 10 mm, 12 mm and 18 mm thread adapters.
- Blow molded hard case with removable lid.
- Detailed instruction chart.



5610
Transmission/Engine Oil Pressure Kit

This professional kit can be used for domestic and import applications. High and low pressure gauges make this kit useful for both transmission and engine work. Kit comes complete with adapter for most applications. Designed to be used for both static and on road testing.

Features and benefits:

- Large 3-1/2" gauges feature a chrome bezel and rugged protective outer boot.
- Low pressure gauge reads 0-100 psi and 0-700 kPa.
- High pressure gauge reads 0-400 psi and 0-2800 kPa.
- Both gauges include rear hook to allow gauge to be hung conveniently out of the way.
- Gauges and hose assembly incorporate quick couplers for easy disconnect.
- Kit includes 13 adapters and a detailed instruction manual.
- Blow molded hard case with removable lid.



**5613
Vacuum/Pressure Gauge Kit**

Ideal for testing vacuum lines and components. Accurately tests low-pressure fuel systems. Quickly diagnose internal engine problems such as bad rings, valves and leaking head gaskets. Kit comes complete with adapter for most applications. Pin point hard to find problems such as cracked lines, PCV, fuel pump, fuel filters and more.

Features and benefits:

- Large 3-1/2" gauge features a chrome bezel and rugged protective outer boot.
- Dual purpose gauge reads vacuum and pressure.
- Dual scale gauge reads 0-30 in. Hg vac and 0-70 cm Hg, also reads 0-15 psi and 0-100 kPa.
- Built in rear hook allows gauge to be hung at eye level.
- Adapters for most applications.
- Blow molded hard case with removable lid.
- Detailed instruction chart.

**6492
Engine Preluber Kit**

- Ensures oil is present to internal engine components on the first start of a new or rebuilt engine, or after major engine work is performed.
- Required to prime the oil pump and fill the oil galleries and internal engine components with clean, new oil.
- Connects to engine oil system at the oil pressure sensor on a variety of domestic and import engines.
- Oil pressure sensor adapters included.

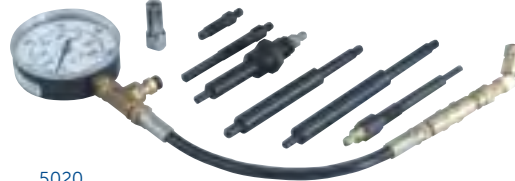
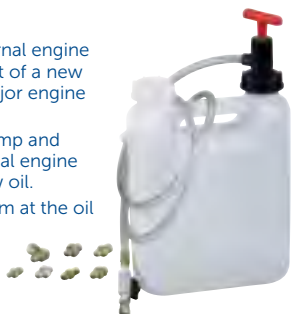

5020
Similar to Ford 303-D091
(D93T-6000-A)



5021
Similar to Ford 303-D092
(D93T-6000-B)

Diesel Compression Tester with Adapters

This easy-to-use compression tester is designed for light- and medium-duty diesel engines equipped with glow plugs. A dual-reading gauge, featuring a push-button release valve, measures compression to 1000 PSI and 7000 kPa. The hose end has quick disconnect fittings. The tester comes with glow plug and nozzle adapters in a handy storage case.

Tester services these engines:

- Cummins B and C
- Navistar DT466/DT360
- Ford/Navistar 6.9L & 7.3L
- Detroit 6.2L & 6.5L
- Hino diesel and Mitsubishi Fuso truck engines

5020	Diesel compression tester with adapters.
5021	Universal diesel engine compression gauge.
304802	Replacement gauge.
Replacement Adapters (available separately)	
47484	Hino diesel truck engines with 12 mm x 1.25 thread
217791	Cummins B 3.9L 4 cyl. & 5.9L 6 cyl. '89-'98
308472	Mitsubishi Fuso truck 4D & 6D engines with 10 mm x 1.25 thread
310810	Cummins C 8.3L 6 cyl. '88-'96
310832	Ford/Navistar 6.9L & 7.3L, Detroit 6.2L & 6.5L with 10 mm x 1.0 thread
310840	Navistar DT466/DT360



**4491
Mechanic's Stethoscope**

- Quick and accurate way to locate vehicle noise.
- Spring diaphragm on end of hose amplifies noise.
- Includes two hose ends: long rod helps pinpoint noises in hard-to-access areas; short adapter helps locate noise in a broader area of the vehicle.



6982DEX

3-Piece Double Edge Screw Extractors

Damaged and frozen bolts can ruin a technicians ability to make rate. Now broken bolts and screws can be easily removed with the 6982DEX 3Pc Double Edge Extractor Set from OTC.

These industrial quality extractors are manufactured from high strength steel and feature a tapered flute for safe and secure engagement in the bore hole and a unique hex shank design to prevent rounded corners. The 6982DEX from OTC covers screw sizes from #10/M5 to 1/2"/M12. Pre-drill bore hole with 1/8", 3/16" or 1/4" drill bits (not included). Drive extractor into bore hole for secure engagement. Can be turned in clockwise and counter-clockwise directions for both right and left handed threads.

Be prepared for broken bolts and screws - make sure you have the 6982DEX 3-Piece Double Edge Screw Extractor Set from OTC within arms reach!

6982DEX-1 No. 1 Dual Edge Screw Extractor (#10 - 1/4")

6982DEX-2 No. 2 Dual Edge Screw Extractor (5/16" - 3/8")

6982DEX-3 No. 3 Dual Edge Screw Extractor (7/16" - 1/2")



6982DGS

Drilling Guide System

Removing a broken stud can be a tricky, time consuming undertaking. Pro's know boring a well centered hole is key to using extractors effectively. OTC now offers a solution to assist you with drilling a perfectly centered hole! The 6982DGS from OTC allows you to anchor off a good stud to perfectly center a drilling alignment guide over a broken one. Place the slot of the rail guide over any good hole with appropriate size bushing and loosely secure with good stud. Slide/pivot opening in rail guide over broken stud and insert alignment guide for drilling. Tighten stud to hold alignment and begin drilling.

The OTC 6982DGS comes with 4 alignment guides for "progressive drilling". To cover most applications we also provide 4 bushings in 6mm, 7mm, 8mm, and 10mm sizes. The OTC 6982DGS is another great quality tool you'll want in your tool box. Lifetime Warranty. Made in USA.

6982DGS-1 4-Pc Bushing Set

6982DGS-2 4-Pc Guide Set

6982DGS-3 Replacement Rail



6982ACP

Automatic Center Punch

Make a center punch mark without using a hammer! The 6982ACP Automatic Center Punch from OTC keeps one hand free to help you place this tool right in the cross hairs to accurately mark the spot. Creates a wide profile mark- ideal to keep drill bits from wandering. Rotate the knurled portion to adjust the striking force (60N to 130N).

The OTC 6982ACP Automatic Center Punch helps the accuracy and professional result of your project. Use to mark for precision drilling for tap setting or general boring. This industrial quality tool is made from machine steel and is nickel plated. Hand guard makes for a comfortable use - further ensuring accuracy. Also may be used as an emergency window breaking tool. Lifetime warranty.



4509
Straight-Blade Hose Cutter

- Cuts rubber hoses ranging from 1/4" to 1-1/2".
- Simply place hose in tool and squeeze handle to cut.
- Replacement steel cutter blade No. 4509-1 is available.

4509-1 Replacement hose cutter blade.



4411
Ratcheting Hose & PVC Cutter (Standard)

- Cuts hose and PVC up to 1-3/8" dia.
- Features metal frame and ergonomic handles for high leverage.
- Compound ratcheting action provides maximum cutting power.
- Will also cut cable and wires.



4412
Ratcheting Hose & PVC Cutter (Heavy Duty)

- Cuts hose and PVC up to 1-3/4" dia.
- Features metal frame and rubber padded ergonomic handles for high leverage and comfort.
- Compound ratcheting action provides maximum cutting power.
- Will also cut cable and wires.



7215
Exhaust Back Pressure Gauge

Quickly read back pressure to determine the amount of restriction in an exhaust system. This gauge accurately measures through the oxygen sensor hole. Its large dial clearly shows pressure from 0-8 psi. The system has a stainless steel braided tube to withstand high-heat conditions.

- Includes a universal adapter for vehicles with thermactor systems.
- Works on domestic & imported vehicles.



6500
Flexihead O2 Sensor Wrench

- Flexible head design assists in the removal of stubborn O2 sensors that are 7/8" in diameter, a common size to most vehicles.
- Features allow extensions or wrenches to apply force in tight areas, even on seized components.
- Pivots to allow more angles of placement.



7807
Heated Oxygen Sensor Socket

We put a slot in the side of this wrench to accommodate connectors on heated oxygen sensors, which usually won't fit in standard sensor wrenches. The extubborn sensors without rounding them off.

- Features 1/2" double square drive, 7/8" hex.



7189
Oxygen Sensor Socket

- Designed to easily remove an oxygen sensor.
- Heat-treated cast steel.
- 7/8" hex, 1/2" square drive (double square for easy access).

Similar to Ford No. T79P-9472-A



6931
Oxygen Sensor Socket

- Works on all domestic and imported vehicles with oxygen sensors.
- Slot in socket's side allows wire clearance.
- Outside rib provides added strength, yet does not restrict access to sensors.
- 1/2" square drive, 1" male hex drive on top, 7/8" six-point opening, 3-7/8" long



7677
Exhaust Hanger Pliers

Many cars and trucks have rubber blocks supporting their exhaust system hanger brackets. These pliers will enable you to quickly and easily remove those push-through brackets from their hangers. These pliers feature a two-position slip joint for use on many sizes of hanger blocks.



4673
7-Piece Sensor Socket Set

Includes:

- 4673-1** 29 mm Vacuum Switch and O2 Socket, 1/2" drive
- 4673-2** 7/8" Vacuum Switch and O2 Socket (wide slot), 3/8" drive
- 4673-3** 27 mm Thermal Sensor Switch, 1/2" drive
- 4673-4** 7/8" Vacuum Switch and O2 Socket (narrow slot), 3/8" drive
- 4673-5** 1-1/16" & 1" Oil Pressure Sending Unit Socket, 3/8" drive
- 4673-6** 7/8" O2 Sensor Socket, offset 1/2" drive
- 4673-7** 7/8" O2 Sensor Socket (low profile), offset 3/8" drive.

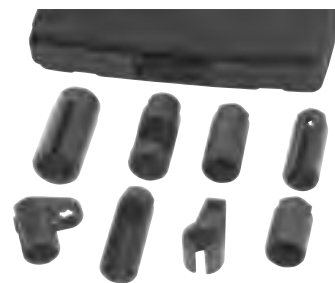

4437
8-Piece Sensor Socket Set

Includes:

- 4673-1** 29 mm Vacuum Switch and O2 Socket, 1/2" drive
- 4673-2** 7/8" Vacuum Switch and O2 Socket (wide slot), 3/8" drive
- 4673-3** 27 mm Thermal Sensor Switch, 1/2" drive
- 4673-4** 7/8" Vacuum Switch and O2 Socket (narrow slot), 3/8" drive
- 4673-5** 1-1/16" & 1" Oil Pressure Sending Unit Socket, 3/8" drive
- 4673-6** 7/8" O2 Sensor Socket, offset 1/2" drive
- 4673-7** 7/8" O2 Sensor Socket (low profile), offset 3/8" drive.
- 4437-8** 1-1/16" and 1" Oil Pressure Socket (short access), 3/8" drive

FUEL

Fuel Injection Service Kits and Clean Fluid **22 – 25**
 Noid Lite/ IAC Test Kits.....**25**
 Fuel Pressure Testers, Line Fluid Stopper Kit,
 Fuel line Fittings..... **26**
 Full-Coverage Disconnect Tool Set**27**
 Fuel Service Disconnect Tools**28**
 Ford 6.0L Service Tools.....**29**
 Fuel Pump Wrenches,
 Water Sensor Wrench..... **30 – 31**
 Hose & PVC Cutters, Tubing Bender and
 Tubing Cutters.....**32**

OIL

Drain Plug Pro.....**33**
 Oil Filter Sockets, Oil line Disconnect
 Tools and Stoppers **34 – 36**
 Oil Transfer Tankers,Fluid Evacuation /
 Brake Bleeding **37**
 Oil Filter Crushers **38**

COOLANT

Cooling System Pressure Test Kits **39**
 Vacuum/Pressure System Tester,
 Cooling System Guns..... **40**
 Hose Clamps, Cutters, Disconnect Tools **41 – 42**

LUBRICANT SERVICE

Grease Guns..... **43**
 Air Blow Guns and Technician Gloves..... **44**





HELP ENGINES RUN
BETTER, EXPAND SERVICE
OPPORTUNITIES

7448A
Canister-type Fuel Injector Cleaner

The 7448A is used exactly the same way as our original product was designed. Disconnect the vehicle fuel pump, adapt the 7448A to the vehicles fuel rail. Add a chemical cleaner like OTC7000A.

Connect to shop air supply and set pressure – open the ball valve and start vehicle. When engine stalls, the cleaning process is complete.

With the addition of a quick connect fitting, the hose is now removable improving storage options – and we include a "blow out" fitting to allow your shops air supply to remove residual cleaners from the line – improving the overall life of the product.

The 7448A now includes our Fuel Injection Application Manual – showing OE fuel pressure specs, fuel pump disconnect points return line information and the adapter reference to OTC pressure adapter kits (6550PRO)! Covers vehicles from 1997 through 2013 model years.

Tool No.	Description
581340	Hose (1/8" NPTF x 6' long) with connector
213299	Air regulator
313575	Gauge 0-100 psi
517145	Gauge cover



6550PRO
Pro Master Fuel Injection Service Kit ●

Covers 100% of vehicles sold in North America market '97-'13.

Perform fuel pressure testing, diagnose weak fuel pumps or restricted filters, test for fuel flow and perform leak-down tests. Use to clean injectors and intake systems. Kit includes:

- 0 – 100 PSI Fuel Pressure Gauge.
- 47 of the popular OTC fuel injection adapters, each equipped with a quick-connect Schrader valve.
- '97 – '13 Fuel Injection Service Application Manual.
- Replacement seal kit also included.









































6550
Master Fuel Injection Kit ■

Test fuel injection systems on most GMs, including GM TBI, Ford, Chrysler, and Jeep vehicles. Also works on imports, including CIS and CISE fuel systems.

- 0–100 PSI fuel pressure gauge.
- 35 of the popular OTC fuel injection adapters, each equipped with a quick-connect Schrader valve.
- '97 – '13 Fuel Injection Service Application Manual.
- Replacement seal kit also included.

CONTENTS OF SETS: ● 6550PRO ■ 6550 (also sold individually)

	518483	Hi-Pressure Gauge 3-1/2", 0-100 psi (0-7 BAR) with quick disconnect, protective gauge boot, and hanger			518482	14 mm x 1.5 External O-ring Plug			518496	M16 x 1.5 External & Internal Swivel Adapter
	518530	Gauge Hose Assembly with Relief Valve			518487	16 mm x 1.5 In-Line Adapter (GM TBI)			549598	M14 x 1.5 Inverted Flare Adapter
	518356	CIS/TBI Hose Assembly with Shutoff Valve			518499	Ford Spring Lock Coupling Adapter			549596	M12 x 1.0 Honda Pulse Damper Adapter
	518477	Seal Kit			518490	M6 x 1.0 External O-ring Adapter			549597	Fuel Pressure Test Adapter, Studded Rail Style (ø.625/16 mm)
	518480	Double Ended Hose Adapter; 5/16", 3/8"			518491	M8 x 1.0 External Banjo Adapter			567840	1/4" T-Fitting Hair Pin Adapter (Honda)
	518478	Single End Hose Adapter; 1/4", 5/16", 3/8"			518492	M10 x 1.0 External Banjo Adapter			549578	Schrader Fitting, 7/16"-20 Internal 90 Degree Elbow
	518495	Schrader Fitting, .308x32 thread (Ford EFI) Ford MPI Adapter			518493	M12 x 1.5 External Banjo Adapter			549579	Schrader Fitting, .308x32 Internal 90 Degree Elbow (Ford)
	518542	Schrader Fitting, 7/16"-20 thread (Chrysler, Jeep & GM)			518494	M12 x 1.25 External Banjo Adapter			528770	Fuel Pressure Test Adapter (ø.430/11 mm)
	518476	5/16" T-Fitting Hair Pin Adapter (Ford)			518501	M14 x 1.50 External Banjo Adapter			528771	Fuel Pressure Test Adapter (ø.580/15 mm)
	518527	3/8" T-Fitting Hair Pin Adapter (Chrysler, Jeep, & GM)			518485	M8 x 1.0 Internal O-ring Adapter (CIS)			528772	Fuel Pressure Test Adapter (ø.625/16 mm)
	518534	5/8"-18 External Flare with Schrader Adapter			518536	M8 x 1.0 External O-ring Adapter (CIS)			528767	M8 x 1.0 External Double Banjo EFI Pressure Test Adapter
	518535	5/8"-18 Internal Flare with Schrader Adapter			518537	M8 x 1.0 Internal long Fitting			528768	M12 x 1.25 External Double Banjo EFI Pressure Test Adapter
	518481	16mm x 1.5 External O-ring Adapter			518488	M8 x 1.0 External O-ring Adapter (CIS) (Long)			528769	M8 Internal Banjo Fitting
	518472	16mm x 1.5 Internal O-ring Adapter			518484	M10 X 1.0 Internal O-ring Adapter (CIS)			528766	M12 Internal Banjo Fitting
	518473	14mm x 1.5 External O-ring Adapter			518489	M10 x 1.0 External O-ring Adapter (CIS)			7666	Decarbonizing Adapter
	518474	14 mm x 1.5 Internal O-ring Adapter			518486	M12 x 1.5 Internal Swivel Adapter (CIS)				
					518498	M14 x 1.5 External & Internal Swivel Adapter				
					518497	1/4" BSPT External & Internal Swivel Adapter				



**4480
Basic Fuel Injection Service Kit**

- Performs running, residual, rail and flow rate pressure tests.
- Kit includes adapters, hoses and fittings to test fuel injection systems.
- Kit includes two popular adapters for import vehicles as well as the GM TBI adapter.
- Professional dual scale gauge reads 0-100 PSI and 0-700 kPa with relief valve, fuel discharge hose and rubber boot.
- Packaged in blow molded carrying case.



**7649A
Fuel Injector Cleaning Kit**

Clogged fuel injectors cause sluggish engine performance, poor fuel economy, and a rough idle. You can easily correct such problems with this injector cleaning kit. It works on a wide range of engines, both domestic and imported. Using our 7000A-1 Pro Inject-R Kleen fluid, you can effectively clean injectors, restore their spray patterns, and prevent recurring deposits. The kit also enables you to do low- and high-pressure fuel system tests. It will also work with your shop's pressurized air supply for more powerful cleaning without expensive propellants.

- Removes carbon from intake and combustion systems when used with fitting No. 7666.
- Includes canister, gauge, hose, fittings, operating instructions.
- 1997 – 2013 Fuel Injection Service Application Manual.



Tool No.	Description
581340	Hose (1/8" NPTF x 6' long) with connector
213299	Air regulator
313575	Gauge 0-100 psi
517145	Gauge cover
518499	Spring lock coupling adapter
518495	EFI quick-disconnect fitting (.307-32 internal; Ford)

Tool No.	Description
518480	Pressure adapter TBI (5/16" and 3/8")
549578	Quick-disconnect 90° elbow fitting (7/16"-20 internal)
528769	Banjo fitting (M8 internal banjo)
314651	Banjo fitting (M10 internal banjo)
518499	Banjo fitting (M12 internal banjo)
47955	Fuel injector cleaner (canister)
7666	Decarbonizing Adapter

6550MAN-13
Pro Fuel Injection Application Manual

Over 200 pages of valuable fuel system service information for professional technicians. English, Spanish and French translations for:

- Safety Precautions.
 - Fuel System Identification.
 - Adapter & Tool Identification.
- General Operation instructions PLUS 1997 to 2013 Make/Model/Year Data points for:
- Fuel Pressure specifications.
 - Fuel Pump Disabling Location and Procedure.
 - OTC adapter reference.
 - Adapter "break-in" location.



7000A-1



7000A

7000A
Pro Inject-R Klean Fluid

Clean fuel injectors mean cleaner running, more efficient engines – and lower emissions. This fluid restores injectors' original spray pattern, helps prevent recurring problems, and reduces intake and port deposits.

- No mixing; use right from the can.
- Pro Inject-R Klean fluid. Case of 12 16-oz. cans.

7000A-1
Pro Inject-R Klean Fluid

- Single can.



4493
Angle-Tip Relay Pliers

- Designed to remove and install relays, which are usually located in confined, hard-to-reach areas.
- Specially coated tips offer a solid grip on the relay.



3054E

3050E
3054E
Noid Lite/IAC Test Kit

Noid Lites are a proven test device to quickly determine if the electrical signal is present at the fuel injector.

- Just plug in and turn over the engine; flashing noid indicates good signal.
- Expanded set of eight Noid Lites cover: GM PFI, Ford TBI, Geo TBI, Bosch PFI, GM TBI, GM SCPI, and now new applications of Bosch 2 and Multec 2.
- Kit comes in molded plastic case and includes a harness extension that allows for convenient remote viewing from the driver's seat.

Tool No.	Description	3050E	3054E
7187	GM TBI Noid Lite	•	•
7188	Bosch PFI Noid Lite	•	•
7601	Ford TBI Noid Lite	•	•
6023	GM Multec 2 Noid Lite	•	•
7602	GM PFI Noid Lite	•	•
7608	Geo TBI Noid Lite	•	•
7828	GM SCPI Noid Lite	•	•
6266	Bosch 2 Noid Lite	•	•
6260	Fiber optic Noid Lite extension	•	•
3052S	'82 and newer GM TBI/PFI IAC tester with square 4-pin connector		•
3053S	'87 and newer Model 700 TBI/PFI with flat 4-pin connector.		•



7211 Gauge and Hose Assembly

This gauge is designed to work with any of our fittings for testing fuel injection systems. It features a sturdy 3-1/2" dial that reads 0-100 psi. It also has a built-in (100-150 psi) retard to prevent excess pressure damage. The assembly's disconnect fitting has a check valve to lessen chance of fuel spray.

- Includes 6-ft. bleed hose and 30" pressure hose.
- Bleed valve eliminates air from injection system and can be used to reduce pressure when disconnecting hoses
- Bleed valve also allows gauge assembly to be used to check fuel pump volume.

306905 Optional pressure hose, 70" long.



5630 Fuel Pressure Tester Kit

Quickly and easily locate any malfunctioning fuel system component, including fuel filters, pressure regulators, fuel lines, and fuel pumps without removing it from the vehicle.

Features and benefits:

- Large, easy-to-read 0-100 psi scale, 0-700 kPa.
- Solid brass fittings.
- Pressure relief valve for safe, clean testing.

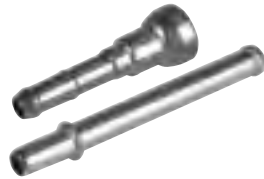

7629 GM Fuel Line Fitting Set (3/8")

- Fits GM vehicles with 3/8" fuel lines.
- Will work on low or high pressure TBI systems.
- Quick, easy, safe. Eliminates makeshift connections that can damage plastic fuel lines or the special connector.
- Use when checking fuel pressure or when cleaning injectors.



7628 GM Fuel Line Fitting Set (5/16")

- Fits GM vehicles with 5/16" fuel lines.
- Will work on low or high pressure TBI systems.
- Quick, easy, safe. Eliminates makeshift connections that can damage plastic fuel lines or the special connector.
- Use when checking fuel pressure or when cleaning injectors.



5613 Vacuum/Pressure Gauge Kit

- Ideal for testing vacuum lines and components. Accurately tests low-pressure fuel systems. Quickly diagnose internal engine problems such as bad rings, valves and leaking head gaskets. Kit comes complete with adapter for most applications. Pin point hard to find problems such as cracked lines.
- Large 3-1/2" gauge features a chrome bezel and rugged protective outer boot.
- Dual purpose gauge reads vacuum and pressure.
- Dual scale gauge reads 0-30 in. Hg vac and 0-70 cm Hg, also reads 0-15 psi and 0-100 kPa.



6703 Line Fluid Stopper Kit

Stop messy fluid leaks and prevent contamination during service.

- Kit seals all types of rubber and steel line found on fuel, brakes, AC, power steering and transmission system.
- Includes two banjo style fitting stoppers, two steel line stoppers, six line plugs, a line disconnect tool, and a long reach line pinch-off tool for hard-to-reach hoses.

6703-1 Banjo Line Fluid Stoppers, 2 pk.

6703-2 Steel Line Fluid Stoppers, 2 pk.

6703-3 Line Plug Fluid Stoppers, 6 pk.

7631 Fuel return line plug (5/16")



7433 Fuel return line plug (3/8")



7342 Quick coupler adapter



528776 Ford EFI adapter



528773 O-ring and washer set for European



528774 O-ring and washer set for Asian



FULL-COVERAGE DISCONNECT TOOL SET



6508

Full-Coverage Disconnect Tool Set

If you're working on Chrysler, Ford, or General Motors vehicles, this set can make your job easier. The tools are designed for heater hoses, transmission oil coolers, air conditioning and fuel lines. They're approved by vehicle manufacturers and will not damage the fittings being disconnected. Tool Nos. 518092, 518896, 518897, 518898, 518899, 518900, and 518901 are spring-loaded in the closed position to deflect any spray that occurs when lines are disconnected.

FULL-COVERAGE DISCONNECT TOOL SET

440384 GM hydraulic clutch line disconnect tool



518583 Fuel line disconnect tool. (Red, 3/8")



519067 5/16" Fuel line disconnect tool



7937 GM transmission oil cooler line



518584 Fuel line disconnect tool. (Black, 1/4")



519068 3/8" Fuel line disconnect tool

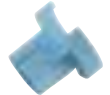

519151 Quick disconnect tool



501153 Toyota A/C tool



518896 Fuel line disconnect tool. (Yellow, 3/8")



519152 Oil cooler line disconnect tool



519153 Clutch coupling tool



511410 3/8" & 5/16" Fuel line disconnect tool



518897 A/C spring lock coupling tool. (Black, 5/8")



519154 Fuel line coupling tool



511413 3/8" & 1/2" Fuel line disconnect tool



518898 A/C spring lock coupling tool. (Blue, 1/2")



519155 Chrysler fuel line disconnect tool



518902 Heater hose disconnect tool

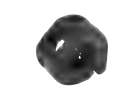

518899 Fuel line disconnect tool. (Green, 1/2")



519156 Ford heater hose disconnect tool



519158 Fuel line disconnect tool set



518900 A/C spring lock coupling tool. (Red, 3/8")



519157 GM heater line quick connect separator



518582 Fuel line disconnect tool. (Gold, 5/16")



518901 A/C spring lock coupling tool. (White, 3/4")



519159 Transmission oil line tool





6517
Disconnect Tool Set

Designed for A/C lines, fuel lines, and transmission cooler lines.

- Contains 3/8", 1/2", 5/8", and 3/4" spring lock disconnect tools for A/C lines on Ford cars and trucks, Chrysler and Jeep vehicles.
- Contains the 3/8" and 1/2" fuel line disconnect tool for Ford vehicles.
- Contains the 5/16" and 3/8" fuel line disconnect tools for GM and Chrysler vehicles.
- Contains the transmission oil cooler line disconnect tool used on many GM and Ford vehicles.

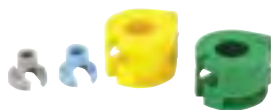

7363
Fuel Line Disconnect Tool Set

- This set works on quick connect fuel lines on Ford, GM, and Chrysler, and on the spring lock fuel line couplings on Ford's popular PFI system.
- Won't damage fuel line or fuel line connectors.
- Used on 5/16", 3/8", and 1/2" fuel lines.
- Two large tools are spring loaded, durable, and completely enclose the hose, which helps deflect any spray.



7337
Ford Fuel Line Disconnect Tool Set

These tools will easily disconnect the spring lock couplings of fuel lines on Ford's throttle body and port fuel injection systems. The tools are spring-loaded and durable, and they enclose the line to help deflect spray.

- Includes 518896 (3/8" yellow) and 518899 (1/2" green) disconnect tools.



7361
Fuel Line Disconnect Tool Set

These two disconnect tools are designed to fit quick-connect fuel line fasteners. They'll work on Chrysler, Ford, or GM vehicles, and separate fuel lines without damaging the connectors.

- Includes 519067 (5/16" gray) and 519068 (3/8" blue) disconnect tools.

Similar to Ford No. 310-S039 (T90T-9550-S)



6554
Fuel / AC Line Disconnect Kit

- Topside disconnects for AC and Fuel lines.
- Clips, disc, and scissor styles for broad applications.
- Hi-visibility line plugs included.

6603A
GM Fuel Line Disconnect Tool

Applications: 2002–newer Tahoe and light-duty trucks with the 5.3L V8 engine.

- This is a required tool to remove the fuel line from the fuel filter.

Similar to Kent-Moore No. J-46363.

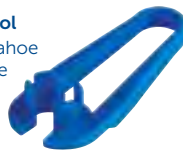

519154
Ford Fuel Line Disconnect Tool Set

Here's the best tool for easy, frustration-free fuel line separation. As you put the tool on the fuel line coupling, its fingers depress the retaining collar to release the fuel line, preventing component damage.

- Works on 1990 to 1995 Ford Ranger and Explorer models fitted with 4.0L, 6-cylinder engines.



4506
Rubber Line Clamp Set

- Set of two clamps. Used to quickly shut off flow from vacuum, brake, and fuel lines.
- Enables you to clamp and hold hose without damage.



6509
3/8" & 5/16" Fuel Line Disconnect Tool

Special low-profile design works in close quarters on GM, Ford, and Chrysler vehicles where there is limited clearance between the fuel line fittings and fuel filters, fuel rails, or sending units.



Similar to Miller No. 8218

6511
3/8" & 1/2" Fuel Line Disconnect Tool

Special low-profile design works in close quarters on GM, Ford, and Chrysler vehicles where there is limited clearance between the fuel line fittings and fuel filters, fuel rails, or sending units. This tool is designed to access the center port on GM fuel tank sending unit. For 3/8" and 1/2" applications; will also service 2001 thru current 3/4- and 1-ton trucks with the Duramax Diesel engines.



4495
A/C and Fuel Line Disconnect Set

- Used to remove A/C and fuel line quick-disconnect fittings from hard-to-reach areas.
- Six sizes (5/16", 3/8", 1/2", 5/8", 3/4", and 7/8") available to work on many import/domestic vehicles.



6770
Ford 6.0L Diesel Service Tool Kit

- 8 of our popular 6.0L Diesel Service Tools in one convenient kit.
- Properly test vehicle systems for leaks and blockage.
- Safely remove and re-install harnesses without damage.
- Fuel Filter Cap Wrench, Glow Plug and Injector Harness Release Tools.
- Oil Line Disconnect Tool, EGR Removal Tool.
- IPR Controller, IPR Socket Tool and Fuel Rail Pressure Adapters.



Similar to Ford No. 303-765 and 303-766

6763
Ford 6.0L High Pressure Oil Pump Adapters

Pair of pressure testing adapters for the high pressure oil pump which drives the injectors on the Ford 6.0L.



6764
Ford 6.0L Diesel IPR Controller

When a hard start or no start condition exists, the 6764 allows a technician to close the Injector Pressure Regulator in order to determine if proper injector control pressure is achieved and sustained for the starting process.

- Tactile On/Off switch with LED confirming power to the tool and signal to the Injector Pressure Regulator.
- Permits a quick initial diagnosis of the pressure regulator when a hard start-no start situation exists.
- Used in conjunction with any scan tool capable of reading fuel pressure on 6.0L Ford Diesel.



Similar to Ford No. 303-1115

6766
Ford 6.0L Diesel Terminal Release Tool

This Terminal Release Tool is required for removal of the vehicle's injector wiring harness without causing damage to the component.



Similar to Ford No. 303-1114

6768
Ford 6.0L Glow Plug Release Tool

Safely remove and install the glow plug harness on 2004-2009 Ford 6.0L Diesel engines.



6760
FORD 6.0L & 7.3L Fuel Filter Wrench

Designed to remove and install the fuel filters on the Ford 6.0L & 7.3L Power Stroke diesel engines as well as International / Navistar diesel engines.

- Low profile design for easy access in tight areas.
- Reversible Six lug design provides the convenience of two sizes in one tool.
- Light weight low profile for strength and durability.
- 3/8" drive allows the wrench to be used with a variety of drive tools.

6594
Ford Oil Line Disconnect Tool

- Use to disconnect the high-pressure oil rail supply line from the fuel rail when removing fuel injectors.
- Works on the 6.0: diesel engine found in 2003-2009 F-250, F-350, F-450, F-550 trucks, Excursions and Ford vans.

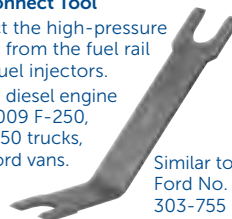

Similar to Ford No. 303-755



Similar to Ford No. 303-769 and 303-1112

6765
Ford 6.0L Diesel Injector Pressure Regulator Socket

This Injector Pressure Regulator Socket actually combines two OE tools into one. The socket changed in 2005 - so the socket give you the capability to address either platform.

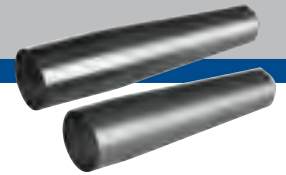

6707
Injector Seal Installer Adapters

Two-piece kit includes tools to properly size the seal and install the seals in the proper groove on the injector tip for leak-free operation. Works to install both seals on the injector tip. Similar to EN-51105.

Applications: 2014-15 Chevrolet Silverado & GMC Sierra V6 and V8, 2015 Chevrolet Suburban/Tahoe, GMC Yukon/XL, 2014 Chevrolet Corvette, 2015 Cadillac Escalade.



5089
Air Brake Line Release Tools

Tools used to separate connectors on the P/S system and EGR coolers without damage. Also works on connectors on other liquid and air lines. Each tool has two sizes. 3/8" and 5/8"; 1/2" and 3/4". Similar to J-45666 & J-42971.

Applications: 2003-later Medium Duty trucks.



6710
Fuel Pump Installation Gauge

Verifies that the camshaft fuel pump lobe is at base circle position before installing the high pressure fuel pump. Tool indicates the pump may be installed when it is flush to manifold surface. Similar to EN-51092.

Applications: 2014-15 Chevrolet Silverado & GMC Sierra V6 and V8 engines, 2015 Chevrolet Suburban/Tahoe, GMC Yukon/XL, 2014 Chevrolet Corvette, 2015 Cadillac Escalade V8 engines



6708
Injector Retaining Clip Replacer

Removes and installs the injector retaining clips without over-spreading to ensure proper retention of the injector to the rail. Similar to EN-51097.

Applications: 2014-15 Chevrolet Silverado & GMC Sierra V6 and V8 engines, 2015 Chevrolet Suburban/Tahoe, GMC Yukon/XL, 2014 Chevrolet Corvette, 2015 Cadillac Escalade V8 engines.



6752
Similar to Ford No. 303-D113



6753
Similar to Ford No. 303-D115

Designed for the diesel truck market, this tool will work for just about any injector you need to remove for service or replacement.

**6752
Fuel Injector Storage Rack with Protective Cups**

Compartment are marked to help keep the injectors organized by the cylinder they came from in order to keep the injector calibration in sync with the vehicles ECM.

**6753
Protector Cups.**

A set of eight replacement cups for 6752 Fuel injector storage rack.



Similar to Ford No. 303-491 No. 303-492

**6067
Ford Injector Remover / Installer Kit**

- Removes and installs injectors without damaging the injector or cylinder head.

Application: 1994–2003 Ford 3/4- and 1-ton trucks, Super Duty trucks, and vans with 7.3L direct-injected turbocharged (DIT) diesel engine.



**7998
Chrysler Fuel Pump Module Spanner Wrench**

Removes and installs the fuel pump retaining ring that holds the fuel pump module onto the gas tank. Works on most 1994–2005 Chrysler vehicles, and 1995–2004 Jeep vehicles.

Similar to Miller No. 6856.



**6599
Fuel Tank Lock Ring Wrench**

Universal design allows tool to fit fuel tank lock rings on Ford, Chrysler, and GM vehicles with gas engines.

- Works on: 2004–newer Ford F-150 trucks; 2004–newer Chrysler / Dodge minivans, PT Cruiser, Dakota, and Durango; 2004–newer Chevy 1/2-ton and 3/4-ton trucks; and 2005–newer Jeep vehicles.
- Fits 7-5/16" diameter lock rings.
- Tool easily removes and installs lock ring on the fuel tank when servicing the fuel pump or fuel sending unit.
- Used with a 1/2" drive ratchet or breaker bar.



**6556
Fuel Sender Lock Ring Wrench**

Designed for removing the newly-designed 4-1/2" fuel sender lock ring on 2003 - 2011 Cadillac CTS, SRX and STS models. The lock ring requires high torque to loosen and tighten, requiring a specialized tool for service. Standard 3/8" square center drive hole for balance and maximum force available to remove and tighten. Similar to J-45747.

Similar to Ford 303-230



**7460
Diesel Fuel Line Wrench**

Fuel line nuts are often hard to reach, but this unique 3/8" square-drive tool solve that problem. You can loosen or tighten fuel lines at the fuel injector nozzle or fuel injection pump without damaging the nut.

- Fuel line wrench, 2.6" long. For International 6.9L and 7.3L diesel engines. Fits 5/8" hex nut.



**7148
Propane Enrichment Kit**

- Ensures a correct idle mixture and compliance with emission standards.
 - Works on domestic or imported vehicles.
 - Uses standard 14-oz. propane cartridge.
- Similar to Ford No. 310-003 (T75L-9600-A).



**7667
GM Computer-Controlled Carburetor Tools**

These tools are designed to adjust settings on computer controlled Rochester, DualJet, QuadraJet, and VaraJet carburetors on carbureted GM engines.

Applications:

- 2 mm double-D – VaraJet lean authority screw and idle air bleed; and DualJet and QuadraJet mixture control adjusting screw.
- 2.5 mm hex – DualJet and QuadraJet TPS adjusting screw.
- 7 mm double-D – DualJet and QuadraJet main metering jets.
- 10 mm double-D – DualJet and QuadraJet mixture control solenoid-rich screw.



**7454
Fuel Injector Nozzle Puller**

- Pulls fuel injection nozzles on Ford 6.9L/7.3L and Navistar DT466/9L diesel engines.
- Slide hammer action gives an even, straight pull on the nozzle for fast, easy removal.
- Puller nut screws onto injector nozzle inlet port.

**FOR PRODUCT VIDEOS VISIT
OTCTOOLS.COM**





Similar to Miller No. 8318

6069

Cummins Diesel Fuel Injector Remover Kit

Kit contains a fuel injector connector tube remover and fuel injector puller. The fuel injector connector tube must be removed before removal of the injector, or both will be damaged.

Application: 1998-1/2-2002 Dodge pickups and vans with 5.9L 24-valve Cummins diesel turbo engine.



5060

Detroit Diesel Injector Socket

Used on GM 6.2L and 6.5L engines. This 30 mm socket ensures proper fit during nozzle removal and installation. The 3/8" square drive and 7/8" hex permit easy access in tight quarters, and prevent damage to nozzle and related components.



5025

OTC DEF Refractometer

SCR & EPA 2010

EPA regulations require all diesel engines manufactured on or after January 1, 2010 to meet lowered NOx emissions standards.

- Most heavy duty engine (Class 7-8 trucks) manufacturers, have chosen to utilize SCR. This includes Detroit Diesel (DD13, DD15, and DD16 models), Cummins (ISX line), PACCAR, and Volvo/Mack.

Application:

The refractometer is a portable, precision, optical instrument used for measuring the Diesel Exhaust Fluid (DEF) concentration. When a liquid sample is placed on the prism, the light passing through it is bent. The more concentrated the liquid, the more the light will bend. The refractometer contains a reticle, or scale, that is enlarged through the eyepiece to measure this light. The values on the scale have been established to evaluate the DEF condition.



6916

Duramax Water Sensor Wrench

- Used to remove and install the water sensor on the fuel filter.
- Works on 2001 and Newer 6.6L Duramax Diesel found in Chevrolet and GMC Trucks and Vans.
- 3/8" square drive hole.



Similar to Kent-Moore J-41089

Similar to Kent-Moore J-41711

6087

GM Injection Pump Wrench Set

- Use to loosen or tighten injection pump retaining bolts whenever pump timing adjustment or pump service is required. Services 1996-1999 GM full-size 2- and 4-wheel drive trucks, vans, and Suburbans with 6.5L diesel engine.
- Two specially bent wrenches are needed, due to the location of the throttle, cruise control, T.V. cable bracket, cooling system crossover pipe and bracket, and the thermostat housing on vans and pickups.
- Wrenches are 15 mm, 12-point, double box-end type.



6914



6915

Davco Diesel Filter Wrenches

- Found on Caterpillar, Cummins, Detroit Diesel, International, Mack, Mercedes-Benz, Volvo and other engines.
- Durable steel construction.
- Precise, laser-cut angles.
- Opens vent cap also.
- Soft, ergonomic handle.

6914

Fits Davco Diesel filter models, 232-233-234.

6915

Fits Davco Fuel filters 382 & 384.



6754

Diesel Fuel Pressure Gauge

- Designed to test fuel pressure on GM Duramax diesel engines.
- Similar to J-44638.



6778

6779

GM Duramax Injector Pullers

- Designed to pull injectors on a GM Duramax 6.6L engines.

6778 2001 - 2004, Similar to J-44639.

6779 2005 - 2011, Similar to J-46594.



**4510
Hose Pinch Off Pliers Set, 3 Piece**

- Shuts off flow through vacuum lines, fuel lines, coolant lines, etc.
- Cocking ratchet mechanism holds pivoting jaws tightly in place. Heavy-duty swivel jaws pivot to assure parallel pinching.



**6512
Heavy-Duty Tubing Cutter**

- Works on tubing sizes 1/8" to 1-1/8" O.D. (3mm to 29mm).
- Easily cuts copper, brass, aluminum, and steel brake lines.
- Reamer folds onto cutter body for storage.
- Extra cutting wheel stored under reamer.



**6514
Mini Tubing Cutter**

- Works on tubing sizes 1/8" to 5/8" O.D. (3mm to 16mm).
- Easily cuts copper, brass, aluminum, and steel brake lines in hard-to-reach places.
- Extra cutting wheel stored in knob.

**6515
3-in-1 180° Tubing Bender**

- Capable of making 180° bends in copper, brass, aluminum, and steel tubing.
- Just one tool works on three sizes of tubing: 1/4", 5/16" and 3/8".

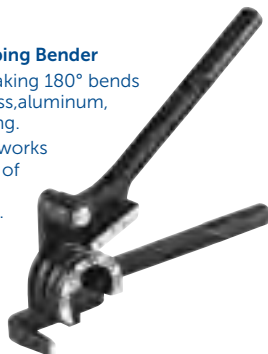

**4509
Straight-Blade Hose Cutter**

- Cuts rubber hoses ranging from 1/4" to 1-1/2".
- Simply place hose in tool and squeeze handle to cut.
- Replacement steel cutter blade No. 4509-1 is available.

**4509-1
Replacement hose cutter blade.**



**4411
Ratcheting Hose & PVC Cutter (Standard)**

- Cuts hose and PVC up to 1-3/8" dia.
- Features metal frame and ergonomic handles for high leverage.
- Compound ratcheting action provides maximum cutting power.
- Will also cut cable and wires.



**4412
Ratcheting Hose & PVC Cutter (Heavy Duty)**

- Cuts hose and PVC up to 1-3/4" dia.
- Features metal frame and rubber padded ergonomic handles for high leverage and comfort.
- Compound ratcheting action provides maximum cutting power.
- Will also cut cable and wires.



**4522
Vacuum Hose and Fuel Line Removal Tool**

- Designed to remove vacuum hose or fuel lines (3/16" to 1/2") from fittings or tubing.
- Simply place the black jaw on the fitting or tubing – the jaw will grip the material. Then use the silver jaw to push the vacuum hose or fuel line off the fitting or tube.



**4723
Ear-type CV Boot Clamp Pliers**

- Designed to crimp the ear-type CV boot clamps used on front-wheel drive vehicles.
- May also be used to crimp the type of clamps used on fuel and cooling system hoses.
- Ensures even, precise crimping, and eliminates possibility of damage to the clamp, boot, or hose.



**4721
CV Boot Clamp Cutter**

- Designed to easily cut the CV boot clamp without damaging the boot.
- Will cut boot clamps up to 10 mm wide and .7 mm thick.
- Handles are spring loaded to the open position to allow easy access to the clamp.



**4403
Tubing Bender**

- For 3/16" and 1/4" dia. tubing.
- Can bend up to 180+ degrees.
- Quick release handle to easily remove tubing from bender.
- Sturdy steel construction.



**4404
Tubing Bender**

- For 5/16" and 3/8" dia. tubing.
- Can bend up to 180+ degrees.
- Quick release handle to easily remove tubing from bender.
- Sturdy steel construction.



8260

Hose Removal Set, 6 Piece

- Consisting of six (6) hose removal tools which consists of three (3) 10", soft-handled tools and three (3) 15", soft-handled tools, each with a hard end-cap.
- They are made of heat-treated, chrome steel with assorted tip shapes.
- Ergonomic handle design fits properly in the hand, allowing for easier holding of the tool.
- Hose removal tools can also be used on upper and lower radiator hoses, clips, washers, gaskets and other items.
- Packaged in a molded tray which can be placed in tool drawer.

**FOR PRODUCT
VIDEOS VISIT
OTCTOOLS.COM**



**HOT OIL IN THE PAN,
NOT ON YOUR HAND**



Strong magnetic end.

**5911A
Drain Plug PRO**

- The OTC 5911A magnetically attaches to pre-loosened oil pan drain plugs so you can remove them without dropping and avoid getting burned with hot oil.
- The patented design provides universal application to hex heads. A flexible shaft can be used in virtually any location and still turn the plug as desired.
- An added feature of the 5911A is a removable magnetic end with 1/4" square drive. When removed, the drain plug pro becomes a flexible-shaft 1/4" bit driver.
- Use for sockets and bit holders to get into hard-to-reach places including under dashboards and in engine bays to remove bolts once loosened. Designed for repetitive daily use with a Lifetime warranty.



5961

**5961
Drain Plug PRO Kit**

The original innovation meets customer feedback for the broadest application possible! The 5961 Drain Plug PRO kit from OTC utilizes:

- 1/4" square drive.
- Mounted on a practical flexible cable.
- A variety of attachments.

All these components combine to give you safe removal of automotive drain plugs in any market!

Includes:

- Standard drain plug attachment.
- Low profile drain plug attachment.
- 17mm hex attachment for internally driven drain plugs.
- 5/16" bit driver attachment.
- All are conveniently stored in socket rail fashion.

Protect your hands and arms from hot oil in any application! Save time by preventing a dropped or lost drain plug. Never fish a dropped drain plug from a pan full of hot oil again! And, you can use the 1/4" square drive with any 1/4" drive socket you already own, to start bolts in hard to reach locations. The handy 5/16" bit driver lets you start screws in hard to reach places as well.



5961HD

**5961HD
Heavy-Duty Drain Plug Pro™**

- For Agricultural, Commercial, and Heavy-Duty Vehicle Applications
- Remove fluid drain plugs without touching the plug or hot fluids!
- No touching hot plugs.
- No hot fluids on hands.
- Removable attachment permits use with common 3/8" square drive sockets. Great for starting bolts in hard-to-reach places.
- Attach to pre-loosened drain plugs and rotate to remove.
- Magnetic attachment for internal 1/2" square drive drain plugs.
- Magnetic attachment for large drain plugs.



6784
Euro/GM Oil Socket Kit

Popular oil filter wrenches for the GM, BMW, Audi, and VW. High quality, 3/8" drive, forged sockets designed to last a lifetime.

3-piece oil socket kit contains:

- 27 mm socket for the Cadillac STS 3.2L V6 and the Mercedes-Benz 1.8L I4.
- 32 mm socket for the 2.2L GM Ecotec and Saabs.
- 36 mm for the BMW M52, M60, M62, M70, & M73 engines; M-B OM604, 605, & 606 engines; VW/Audi VR6 engine.



6786
Oil Filter Cartridge Set

- Fits today's oil filter cartridge style filter applications.
- Short socket style allows for proper clearance when removing the filter element.
- 24mm – Cadillac, BMW. • 27mm – Cadillac, Mercedes, Buick, Saturn, Saab, Smart, VW.
- 29mm – Dodge.
- 32mm – Saturn, Saab, various GM.
- 35/36mm – Ford, Mini Cooper, Mercedes, BMW, VW/Audi, Mack Truck.
- 38mm – small Diesel engine applications.

Similar to Kent-Moore No. J-29142.



6901
GM Oil Filter Socket

Applications: 1999–2002 Olds Intrigue and 2001–2002 Olds Aurora with 3.5L V6 engine.

- This is a required tool to remove the oil filter cap from the oil pan to access the filter cartridge.



6903
Ford / Mazda Oil Filter Socket—75.6 mm, 14 Flutes

- Designed at 75.6 mm to fit 2.3L 4-cylinder engines.
- Works on Ford Fusion, Mercury Milan, Mazda 3, Mazda 5, and Mazda 6.



6904
Hyundai and Kia Oil Filter Socket—88.5 mm, 15 Flutes

- Works on newer Hyundai Sonata and Santa Fe 3.3L V6 engines.
- Works on newer Hyundai Azera, Veracruz and Entourage 3.8L V6 engines.
- Works on newer Kia Amanti, Sedona and Sorrento 3.8L V6 engines.



6905
Oil Filter Socket

- Socket fits between the exhaust manifold and the oil filter for easy removal and installation of the filter.
- Fits 66.5mm oil filters with 14 flutes.



6906
Toyota Oil Filter Socket—65 mm, 14 Flutes

- Avalon
- 2005–'07 V6 3.5L (2GR-FE), 1995–2004 V6 3.0L (1MZ-FE)
- Camry
- 2007 V6 3.5L (2GR-FE), 2004–'06 V6 3.3L (3MZ-FE), 1994–2006 V6 3.0L (1MZ-FE)
- Camry Solara
- 2004–'07 V6 3.3L (3MZ-FE)
- Highlander
- 2004–'07 V6 3.3L (3MZ-FE) — also works on the hybrid version of this engine
- 2001–'03 V6 3.0L (1MZ-FE)
- RAV4
- 2006–'07 V6 3.5L (2GR-FE)
- Sienna
- 2007 V6 3.5L (2GR-FE)
- 2004–'06 V6 3.3L (3MZ-FE)
- 1998–2003 V6 3.0L (1MZ-FE)



6908
Toyota Tundra 4.7L Oil Filter Socket—73 mm, 14 Flutes



4568

Three-Leg Oil Filter Wrench

- Fits filters ranging from 2-1/2" to 5-1/4" (65 mm to 135 mm) in diameter.
- To turn the tool, use a 1/2" ratchet in the ratchet drive or a 13/16" wrench on the nut.
- Knurled legs provide extra gripping power.



4440

Heavy-Duty 3 Leg Filter Wrench Standard

- Self gripping design for true universal fit from 3" to 4-3/4".
- Heavy duty knurled leg design for extra grip and strength.
- 1/2" square drive with 21mm hex option.



4441

Heavy-Duty 3 Leg Filter Wrench Large

- Self gripping design for true universal fit from 4" to 6 1/2".
- Heavy duty knurled leg design for extra grip and strength.
- 1/2" square drive.



4582

Jointed Jaw Standard Filter Pliers

- Jointed jaws rotate 180 degrees providing access where standard pliers do not.
- Slip joint handle design provides a range from 2-1/4" to 4-3/4".
- Jaw teeth and cushioned handles provide maximum gripping power for slip free operation.



4561

4562

Adjustable Oil Filter Pliers Set (4560 and 4561)

- Forged jaws with sure-grip teeth grab the filter for easy removal.
- Slip-joint ratchet and lock mechanism allows a secure grip on filter diameters of 2-1/4" to 7" (57 mm to 178 mm).



4560

4560

Small adjustable oil filter pliers.

- Pliers is 13-1/2" long; fits filters ranging from 2-1/4" to 5" (57 mm to 127 mm) in diameter.



4584

Jointed Jaw Large Filter Pliers

- Jointed jaws rotate 180 degrees providing access where standard pliers do not.
- Slip joint handle design provides a range from 3-1/8" to 7-1/2".
- Jaw teeth and cushioned handles provide maximum gripping power for slip free operation.



4555



4556



4557

Heavy-Duty Oil Filter Wrenches

- Fit filters ranging from 4-1/8" to 5-3/4" (105 mm to 145 mm) in diameter.
- Feature a 1-1/2" wide steel band that can stand up to the high torque needed to remove filters from trucks, tractors, and other heavy equipment.
- Use with a 1/2" drive ratchet or breaker bar.

4555

Heavy-Duty Oil Filter Wrench

- Fits filters ranging from 4-1/8" to 4-3/4" (104 mm to 120 mm) in diameter.

4556

Heavy-Duty Oil Filter Wrench

- Fits filters ranging from 4-1/2" to 5-1/4" (115 mm to 135 mm) in diameter.

4557

Heavy-Duty Oil Filter Wrench

- Fits filters ranging from 5" to 5-3/4" (125 mm to 145 mm) in diameter.

Swivel Handle Oil Filter Wrenches

- Fit filters ranging from 2-1/2" to 4-3/8" (73 mm to 111 mm) in diameter.
- Feature a 1" wide stainless steel band for positive grip on the filter; swivel handle makes it easy to turn filters in hard-to-reach areas.

- 4565 Swivel handle oil filter wrench.** Fits filters ranging from 2-1/2" to 3-1/8" (64 mm to 80 mm) in diameter.

- 4566 Swivel handle oil filter wrench.** Fits filters ranging from 3-1/8" to 3-3/4" (80 mm to 95 mm) in diameter.

- 4567 Swivel handle oil filter wrench.** Fits filters ranging from 3-3/4" to 4-3/8" (95 mm to 111 mm) in diameter.



4565

4566

4567



Similar to Ford No. D79L-6731-A

**7062A
Universal Filter Wrench**

This filter wrench will stand up to the job of removing nearly any spin-on filter (up to 6"). Universal design permits use on most vehicles. The tough 2" wide nylon strap holds firmly. In fact, the more leverage applied, the tighter it grips.

- Accommodates a 3/8" drive ratchet.



6914



6915

Davco Diesel Filter Wrenches

- Found on Caterpillar, Cummins, Detroit Diesel, International, Mack, Mercedes-Benz, Volvo and other engines.
- Durable steel construction.
- Precise, laser-cut angles.
- Opens vent cap also.
- Soft, ergonomic handle.

6914

Fits Davco Diesel filter models, 232-233-234.

6915

Fits Davco Fuel filters 382 & 384.



**4848
Flexible Spout Funnel**

Many oil, transmission, and coolant fluid fill caps are located in hard to access areas. This aluminum 5 1/2" funnel features a removable debris screen in the base flowing to a 25" flexible spout designed to reach these difficult fill locations.



**4673
7-Piece Sensor Socket Set**

Includes:

4673-1
29 mm Vacuum Switch and O2 Socket, 1/2" drive.

4673-2
7/8" Vacuum Switch and O2 Socket (wide slot), 3/8" drive.

4673-3
27 mm Thermal Sensor Switch, 1/2" drive.

4673-4
7/8" Vacuum Switch and O2 Socket (narrow slot), 3/8" drive.

4673-5
1-1/16" & 1" Oil Pressure Sending Unit Socket, 3/8" drive.

4673-6
7/8" O2 Sensor Socket, offset 1/2" drive.

4673-7
7/8" O2 Sensor Socket (low profile), offset 3/8" drive.



**4437
8-Piece Sensor Socket Set**

Includes:

4673-1
29 mm Vacuum Switch and O2 Socket, 1/2" drive.

4673-2
7/8" Vacuum Switch and O2 Socket (wide slot), 3/8" drive.

4673-3
27 mm Thermal Sensor Switch, 1/2" drive.

4673-4
7/8" Vacuum Switch and O2 Socket (narrow slot), 3/8" drive.

4673-5
1-1/16" & 1" Oil Pressure Sending Unit Socket, 3/8" drive.

4673-6
7/8" O2 Sensor Socket, offset 1/2" drive.

4673-7
7/8" O2 Sensor Socket (low profile), offset 3/8" drive.

4437-8
1-1/16" and 1" Oil Pressure Socket (short access), 3/8" drive



Similar to Ford No. 303-755

**6594
Ford Oil Line Disconnect Tool for 6.0 L**

- Use to disconnect the high-pressure oil rail supply line from the fuel rail when removing fuel injectors.
- Works on the 6.0: diesel engine found in 2003-2009 F-250, F-350, F-450, F-550 trucks, Excursions and Ford vans.



Similar to Ford 303-625

**6595
Ford High Pressure Oil Line Disconnect Tool**

- Use to disconnect the high pressure oil line from the cylinder head.
- Works on 1998 - 2003 Ford vans and trucks with 7.3L direct-injected, turbo-charged (DIT) diesel engines.



6703-3

6703-1

6703-2



**6703
Line Fluid Stopper Kit**

Stop messy fluid leaks and prevent contamination during service.

- Kit seals all types of rubber and steel line found on fuel, brakes, AC, power steering and transmission system.
- Includes two banjo style fitting stoppers, two steel line stoppers, six line plugs, a line disconnect tool, and a long reach line pinch-off tool for hard-to-reach hoses.

**6703-1
Banjo Line Fluid Stoppers, 2 pk.**

**6703-2
Steel Line Fluid Stoppers, 2 pk.**

**6703-3
Line Plug Fluid Stoppers, 6 pk.**



Fluid Evacuation / Brake Bleeding Tools

- Use to bleed brake systems and remove a variety of fluid from vehicles, such as antifreeze, oil, transmission fluid, gear lube, etc.
- Quick connect locking hose adapters and ball-style on/off valve on hose prevent fluid leakage.
- Equipped with a relief valve to prevent over-pressurizing the tank.

8100 Operates by shop air or a hand pump; shipped complete with a brake bleeding hose, fluid evacuation hose, and two suction hoses (6 mm & 7 mm); 10-liter capacity tank.

8101 Operates with shop air; shipped with a brake bleeding hose and fluid evacuation hose; 6-liter capacity tank.



Transfer Tankers

- Draining oil from a large displacement engine and getting it to your bulk storage container is a snap with OTC's Transfer Tankers.
- Used oil is collected in a reservoir, and then rolls smoothly on 4" free-wheeling casters to your storage location.
- Pump moves five gallons a minute through the 8-foot transfer hose to the a 15-gallon reservoir.
- Handle is removable for easy storage.
- Screen attached to reservoir allows assembly to be stored on its side.
- Can also be used for transferring antifreeze.

5077A **Low profile Transfer Tanker** is only 7-1/2" from floor to top of reservoir. Comes equipped with an electric pump (No. 528093).

5097 **Low profile Transfer Tanker** is only 7-1/2" from floor to top of reservoir. Comes equipped with a pneumatic pump (No. 529966).

1577 Low Profile Fluid Receiver

- Designed for receiving waste fluid during a wide range of repair jobs.
- Fluid capacity: 7.5 gallons.
- Constructed of polyethylene plastic for heavy-duty use—yet, only weighs 13 pounds.
- Low profile, only 5" high, it easily slides under passenger cars.
- Designed with four casters to provide efficient maneuverability.
- Suitable for cooling system repair jobs—can be used for antifreeze.
- Includes splash screen to prevents pillage and splashing.
- Two-year warranty.





1821
10-Ton Capacity, Air-operated Automotive Oil Filter Crusher

- Crushes up to four automotive filters (3-7/8" dia. x 9" high) at one time, in approximately 20 seconds. Engineered and built for dependable operation. Covered by OTC Lifetime Warranty®.
- 100% air operation eliminates electrical connections. Generous size of crushing chamber easily accommodates the largest automotive spin-on filters.
- Includes mounting stand. No wall mounting or time consuming installation required.



1877
25-Ton Capacity Heavy-Duty Oil Filter Crusher

- Handles the big filters (up to 6" dia. and 12-1/2" long) found in trucks, construction equipment, farm implements, etc. May also be used for automotive and light truck filters. It does it all!
- Crushes filters to 1/4 of original size, removing up to 95% of filter's oil capacity. Automatic cycle feature: load the filter, push a button, and walk away.
- Air/hydraulic pump works on standard shop air (requires 9 CFM at 100 psi). Special valving returns ram automatically at the end of each cycle. No electrical connections needed.
- Built-in floor stand (completely assembled). Whole unit requires just 5 square feet of floor space.
- Covered by OTC Lifetime Warranty®.



Shipped assembled

1896
25-Ton Capacity High-Speed Heavy-Duty/Automotive Oil Filter Crusher

- Automotive and heavy-duty filters up to 15-1/4" long and 6" diameter are crushed in approximately 8 to 16 seconds. Filters are reduced to 20% of original size, with 95% of residual oil removed.
- Automatic cycle feature lets you load the filter, push a button, and walk away.
- Powered by 2 hp electric/hydraulic pump, 230 volt, 20 amp, 60 cycle, single phase, 3,450 rpm. Has a 2-gallon reservoir.
- Built-in, heavy-duty floor stand with leveling pads is designed to accept a 30-gallon drum for oil drainage. Comes assembled. Covered by OTC Lifetime Warranty®.



**SEE PAGE 35
FOR OIL FILTER
WRENCHES**

Oil Filter Crusher Comparison Chart

No.	Tonnage	Pump	Crushing Time	% Oil Removed	Filter Size	Stand Dimensions
1821	10-ton	Air	20 Seconds	95%	Chamber: 8" x 8" x 9" H.	18-1/2" W x 24" D x 63-1/2" H
1877	25-ton	Air/Hyd.	80 Seconds	95%	6" Dia. - 12-1/2" Long	18-1/2" W x 30" D x 74-1/2" H
1896	25-ton	Elec./Hyd.	16 Seconds	95%	6" Dia. - 15-1/4" Long	27" W x 30" D x 78" H

Note: Crushing times are approximate; crushing times may vary depending on air pressure available, size of filter, type of filter, etc.



7991
Cooling System Pressure Tester

Now you can pressure test the cooling system on most cars, light commercial trucks, motorcycles, and even marine applications. The tester's universal fit eliminates the need for multiple adapters.

Note: Will not work on Saturn and Kia cars or Jeep with the plastic reservoir.

- | | |
|---------------------------------|------------------------------------|
| 7991-2 O-ring repair kit | 7991-4 Gauge spare parts |
| 7991-3 Pump parts kit | 7991-7 Main body repair kit |



CAP ADAPTERS NOT REQUIRED

6977
Universal Cooling System Pressure Test Kit

A Cooling System Pressure Test Kit with a truly universal approach to testing vehicle cooling system pressure. The tester adapts to cooling system hoses from 1/4" to 5/8" in diameter. Find a coolant hose connection and insert the adapter to match hose diameter, couple the hand pump with integrated gauge to the adapter and you're ready to test. When finished, relieve system pressure by slowly loosening the cap on the "degas" bottle. Eliminate the search for the right cap adapter and test cooling systems faster.

The hand pump features an easy to read integrated pressure gauge, a padded base to set against vehicle surfaces without scratching and a 36" integrated hose with a quick-coupler mated to the adapters. The hose adapters use durable brass fittings and include a banded spring clamp for easy attachment. A radiator cap adapter with quick connect fitting is included for older vehicles. Every adapter includes a Schrader valve to prevent spray when disconnecting.

This Cooling System Pressure Test Kit covers virtually any make and model that enters your shop and is stored in convenient blow molded case. Covered by OTC's Lifetime Warranty.

Product Features

- Hand Pump with integrated gauge
- Dedicated pressure hose with quick-connect
- Raised gauge to reduce chance of damage if tipped
- Padded base to prevent damage to painted vehicle surfaces
- 4 adapters (1/4", 5/16", 1/2" and 5/8") with Schrader valves to prevent spray
- Includes a cap adapter
- Blow molded storage case





**6975
Vacuum/Pressure System Tester**

The 6975 Vacuum/Pressure System Tester can immediately diagnose leaks in pressure or vacuum systems. The patented design includes an intuitive rotary dial for quick switching between pressure and vacuum and an ergonomic pistol grip with lever. High-quality hoses with quick-couple fittings make quick work of hose/adapter changes and are leak-free under pressure or vacuum.

An integrated rear-mounted gauge provides optimal viewing with testing up to 30 PSI pressure and up to 28 in Hg vacuum. It includes hose adapters, rubber adapters and plastic attachments for diagnosing EGR valves, fuel pressure regulators, thermal and electric vacuum switches, turbocharger waste gates, heating and ventilation control valves, central locking systems, MAP sensors and more. Stored in a convenient blow molded case. Covered by OTC's Lifetime warranty.

Includes:

- Quick Dial Diagnostic Pump Tool
- Silicon-like Hoses (3)
- Black Rubber adapters (2)
- Blue Plastic Adapters (8)



**6976
Cooling System Refilling Gun**

The 6976 Cooling System Refilling Gun can eliminate airlocks during cooling system refilling and eliminates the need for system bleeding. Small and large rubber cones suit both passenger and commercial vehicles with no additional adapters needed. Attach the Cooling System Refilling Gun to your shop air supply then insert the nozzle into the cooling system, like the opening on a radiator and establish vacuum. Insert hose into your new coolant reservoir and switch device to vacuum. It will pull air out of the coolant system while new coolant is added.

Avoid wasting time finding a pocket of trapped air that can cause cooling system failures and inaccurate sensor readings. Packaged in a convenient blow molded storage case. Covered by OTC's Lifetime Warranty.

Includes:

- Refilling gun with integrated hose assembly
- Rubber adapter "stepped" for 1/2" to 1-1/2" diameter opening
- Rubber adapter "stepped" for 1" to 2" diameter opening
- Blow Molded Storage Case
- Operating Instructions



**6978
TestVac Vacuum Test Kit**

OTC 6978 Test-Vac Vacuum Test Kit allows fast, efficient testing and monitoring of many vacuum operated components and also allows one man brake bleeding. The new kit can help find vacuum leaks, test fuel, engine and exhaust valves, door locks, and heating/cooling system performance. Included in the kit are the vacuum pump, fluid container, transfer cap, hoses and fittings, packaged in a convenient blow molded storage case and covered by OTC's Lifetime Warranty.

Includes:

- Vacuum pump with integrated vacuum gauge
- Fluid container with transfer cap
- 2 lengths of vacuum hose
- 12 assorted vacuum hose fittings
- 3 brake bleed fittings
- Instruction Manual
- Blow Molded Storage Case



**6043
Cooling System Power Flush Gun**

Perfectly suited for quick and efficient cooling system flushing. Simply attach it to radiator or heater hoses and you're in business. Also usable in washing engines and even shop floors. Two simple connections: one to shop air and one to a typical water faucet. No. 6043 creates a unique vortex air/water blast for powerful cleaning applications.

Note: While normal water pressure will handle the majority of a cooling system flush, short blasts are sometimes needed to loosen some contaminants from within the system.



**8104A
Vacuum Brake Bleeder**

This one man brake bleeding system allows for fast and efficient vacuum brake bleeding. Universal rubber fitting holds securely on brake bleeder screw. Attach shop air and use the quick release trigger for on-demand vacuum and hands free operation. Compact size and 17 oz. (500ml) capacity.



**8104A-SET
Brake Bleeder with Auto Filler Set**

This one man brake bleeding system allows for fast and efficient vacuum brake bleeding. The Vacuum Brake Bleeder has a universal rubber fitting that holds securely on brake bleeder screw. Attach shop air and use the quick release trigger for on-demand vacuum and hands free operation.

Compact size and 17 oz. (500ml) capacity. The Master Cylinder Auto Filler automatically refills the brake fluid reservoir during brake bleeding. Base plate retaining clip and height adjustment allows fit on all reservoir types. On/Off tap allows installation and storage without drips or spills. 20 oz. (600ml) capacity.

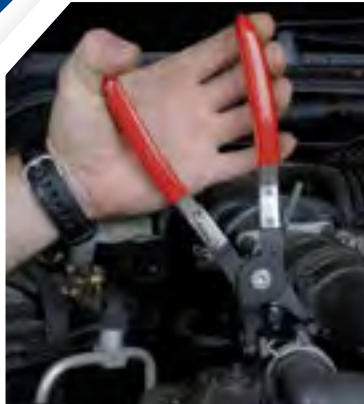

**4502
Hose Clamp Pliers Set (2 piece)**

- Includes a cross-slotted jaw pliers and a wide, flat-band hose clamp pliers. Services most ring-type or flat-band hose clamps.
- The clamps are held open with a ratchet locking mechanism. Jaws swivel to access hose clamps in any position.



**4496
Hose Clamp Pliers Set**

- Contains five different styles of hose clamp pliers, which will service most flat-band and ring-style hose clamps. Also contains a hose removal tool.

Set Contains:

- Straight hose clamp pliers set
- Hose removal tool
- Flat-type hose clamp pliers
- Offset hose clamp pliers
- 45° hose clamp pliers



**4597
Flexible Hose Clamp Pliers with Memory**

- A heavy duty 24" cable flexes to almost any shape and holds it.
- Pliers have locking mechanism to hold clamp in the open position, making removal and installation of clamp easier.
- Allows technician to access the flat type hose clamps located in hard-to-reach areas.



**4523
Offset Hose Clamp Pliers**

- Head is offset from handle to allow access to hard-to-reach clamps.
- Swivel jaws allow pliers to be used on many different flat-band and ring-type hose clamps.



**4723
Ear-type CV Boot Clamp Pliers**

- Designed to crimp the ear-type CV boot clamps used on front-wheel drive vehicles.
- May also be used to crimp the type of clamps used on fuel and cooling system hoses.
- Ensures even, precise crimping, and eliminates possibility of damage to the clamp, boot, or hose.



**4525
Flexible Hose Clamp Pliers**

- Heavy-duty, 24" cable flexes to almost any position.
- Pliers have locking mechanism to hold clamp in the open position, making removal and installation of clamp easier.
- Allows technician to access the flat type hose clamps located in hard-to-reach areas.



**4524
45° Hose Clamp Pliers**

- Jaws are bent at a 45° angle and pliers tips swivel to allow easy access to confined areas.
- Ratchet lock mechanism holds jaws open.
- Works on most flat-band hose clamps.

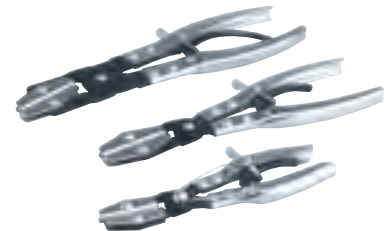

**4510
Hose Pinch Off Pliers Set, 3 Piece**

- Shuts off flow through vacuum lines, fuel lines, coolant lines, etc.
- Cocking ratchet mechanism holds pivoting jaws tightly in place. Heavy-duty swivel jaws pivot to assure parallel pinching.



- 4509**
Straight-Blade Hose Cutter
- Cuts rubber hoses ranging from 1/4" to 1-1/2".
 - Simply place hose in tool and squeeze handle to cut.
- 4509-1** Replacement hose cutter blade.



- 4411**
Ratcheting Hose & PVC Cutter (Standard)
- Cuts hose and PVC up to 1-3/8" dia.
 - Features metal frame and ergonomic handles for high leverage.
 - Compound ratcheting action provides maximum cutting power.
 - Will also cut cable and wires.



- 4412**
Ratcheting Hose & PVC Cutter (Heavy Duty)
- Cuts hose and PVC up to 1-3/4" dia.
 - Features metal frame and rubber padded ergonomic handles for high leverage and comfort.
 - Compound ratcheting action provides maximum cutting power.
 - Will also cut cable and wires.



- 4721**
CV Boot Clamp Cutter
- Designed to easily cut the CV boot clamp without damaging the boot.
 - Will cut boot clamps up to 10 mm wide and .7 mm thick.
 - Handles are spring loaded to the open position to allow easy access to the clamp.



- 4522**
Vacuum Hose and Fuel Line Removal Tool
- Designed to remove vacuum hose or fuel lines (3/16" to 1/2") from fittings or tubing.
 - Simply place the black jaw on the fitting or tubing – the jaw will grip the material. Then use the silver jaw to push the vacuum hose or fuel line off the fitting or tube.



- 4521**
Hose Removal Tool
- Unique tip easily fits between hose and fitting to break stubborn hoses loose.
 - Large handle provides a good grip on tool during hose removal.
 - Works on radiator hoses, heater hoses, transmission lines – any place a rubber hose is clamped to a fitting.



- 8260**
Hose Removal Set, 6 Piece
- Consisting of six (6) hose removal tools which consists of three (3) 10", soft-handled tools and three (3) 15", soft-handled tools, each with a hard end-cap.
 - They are made of heat-treated, chrome steel with assorted tip shapes.
 - Ergonomic handle design fits properly in the hand, allowing for easier holding of the tool.
 - Hose removal tools can also be used on upper and lower radiator hoses, clips, washers, gaskets and other items.
 - Packaged in a molded tray which can be placed in tool drawer.



- 519156**
Ford and Chrysler Heater Hose Disconnect Tool Set
- Quickly and easily removes heater hose from heater core tube without damaging coupling retainer or hose.
 - This set includes the heater hose disconnect tool for 5/8" and 3/4" heater hoses with quick connect couplings at heater core, and an extension handle for easier access.
 - For use on 1986-current Aerostar vans and 1991-current full-size vans, 1987 to current Dodge Caravan and Plymouth Voyager vans.

Similar to Ford T85T-18539-AH



Similar to Kent-Moore J-43181

- 6046**
GM Heater Line Quick-Connect Release Tool
- Specially designed for separating quick-connect fittings on heater lines of 1999–2006 Chevy and GMC C/K trucks.
 - Tool snaps around the hose and simultaneously depresses the locking tabs to disengage the fitting.



Similar to Kent-Moore J-38723

- 519157**
GM Heater Line Quick Connect Separator
- When you need to get at and release the quick connect fitting that connects the heater hose to the engine block and thermostat housing, this little tool is great for saving time and aggravation.
 - Works on 1991-current GM vehicles with 3.1L, 3.4L, and 3800 engines.



2300

Professional Lever Grease Gun

- Heavy Duty Die Cast Aluminum Grease Gun Head.
- Grease Gun Head Fitted with Automatic Air Bleeder.
- Large Diameter Piston for working in cold.
- Built-In variable stroke for greasing fittings with limited access.
- Includes 6" Bent Steel Extension, Easy access 24" High Pressure Hose & 3 Jaw Slim Coupler.
- 10,000 PSI.
- For use with 14 oz. grease cartridge.



2304

Professional Pistol Grease Gun

- Heavy Duty Die Cast Aluminum Grease Gun Head with integrated die cast Fixed Handle.
- Grease Gun Head Fitted with Automatic Air Bleeder.
- Large Diameter Piston for working in cold.
- Built-In variable stroke for greasing fittings with limited access.
- Includes 4" straight steel extension, easy access 24" High Pressure Grease Hose and 3 Jaw Slim Coupler.
- 7500 PSI.
- For use with 14 oz. grease cartridge.



2332

Quick Connect Greasing Accessory Kit

- 7 piece Quick Connect Greasing Accessory Kit
- Includes 1 each of the following Quick Connect Accessories:
 1. Recessed Lube Adapter.
 2. Angle Lube Adapter.
 3. Narrow Needle Nose Adapter.
 4. Seal Off Dispenser.
 5. Right Angled Grease Coupler.
 6. Heavy Duty Hose fitted with Spring Guard and Slim Coupler.
 7. Grease Injector Needle 1.42" Long x 18G.



2310

Air Operated Grease Gun- Continuous Flow

- Heavy Duty Die Cast Aluminum Grease Gun Head.
- Grease Gun Head Fitted with Automatic Air Bleeder.
- Larger Pumping Chamber, honed for rapid operation.
- Includes 6" Bent Steel Extension, Easy Access 24" High Pressure Grease Hose and 3 Jaw Slim Coupler.
- 4800 PSI.
- For use with 14 oz. grease cartridge.



2359

Suction Oil Gun

- For use with gear oils to get them both into/out of gear boxes, transfer cases and differentials.
- 16 oz capacity and 14" hose.



2326

24 inch Grease Gun Hose



2340
Heavy Duty Grease Gun Holder

- Great Grease Gun Storage accessory.
- Can be mounted to walls, machinery, or heavy equipment.
- Design to retain your grease gun in high vibration environments.
- Works with all standard 14 oz. Grease Guns and 16 oz. Suction Guns.



2357
Brass Transfer Pump

- Drain oil from crankcase or ATF through dipstick tube – from underhood – not undercar.
- Includes 24" x 1/2" dia discharge hose
- Includes 40" x 1/4" dia suction hose
- Pumps 3.2 oz per stroke.



2352
Lever Action Bucket Pump

- Fits 5 gallon pails.
- Includes 12" Drum cover.
- 3 Position Handle for different fluid viscosity.
- Steel Discharge Spout.
- Supplied with 5' Hose.
- Up to 4.6 oz. / stroke.
- For use with transmission differentials and heavier oils.

SmartTech™ Technician Gloves

- Works with touchscreen technology.
- Washable synthetic leather palm with padding ensures comfort and a secure grip.
- Polyester and Lycra material around fingers offer a durable lightweight cover that stretches for a great fit.
- PVC cushions help protect knuckles from injury due to slippage.
- Comfortable polyester back panels include webbing for improved ventilation.



5801SGLV-L



- 5801SGLV-L** Large
- 5801SGLV-XL** Extra large



2423
Stainless Steel Tip Blow Gun

- OTC 2423 is designed for operating pressure of 50 PSI to 235 PSI and temperature range of 14° to 158°F
- When inlet pressure is 90 PSI, venting design prevents pressure exceeding 30 PSI if tip becomes blocked - conforming to OSHA Std 1-13.1
- When inlet pressure is 100 PSI, the noise level is held below 80 db conforming to OSHA Std 1910-95 (b), quieter than an electric drill
- 4-1/2"Stainless Steel Nozzle and Variable Speed Trigger for full control of amount of air dispensed
- Impact & Weather resistant materials and drop resistant construction
- Brass threaded air inlet

2424
PRO Series Safety Blow Gun (Standard Tip)

- Die Cast Aluminum body is non corroding and made to last in the harshest environments
- Ergonomic body design and dip coated operating lever reduce fatigue
- Exclusive venturi mechanism uses side ports to create higher volume of usable output
- Tamper-Proof design reduces output to safe levels if ports are blocked
- Meets OSHA standards for Safety and Noise



TRANSMISSION

Transmission Fluid Fill/Extract	46
Chrysler Dipstick	46
Clutch Tools	46
Disconnect Tools	47 – 48
Tubing Cutters	48
Pilot Bearing Pullers	49
Gear & Pulley Pullers	49
Mounting Fixtures	49

DRIVE AXLE

Axle Nut Sockets	50 – 51
Rear Axle Bearing Puller	
Axle Seal Installer	52
Drive Axle Pullers, Seal Protector	53
CV Joint Puller & Pliers	53
Differential Housing Spreader, Ball Hone Set	54



**7445
Chrysler Transmission Dipstick**

The OTC 7445 is for the Chrysler vehicles that didn't come with factory installed dipsticks. Fits Dodge Sprinter and Chrysler Crossfire transmissions, 2003 to current.



**7446
Chrysler Transmission Dipstick**

The OTC 7446 is for the Chrysler vehicles that didn't come with factory installed dipsticks. Fits Chrysler, Dodge, Jeep and Volkswagen with NAG1, 42RLE, CV Transmissions, and 62TE Transaxle.



**5610
Transmission/Engine Oil Pressure Kit**

This professional kit can be used for domestic and import applications. High and low pressure gauges make this kit useful for both transmission and engine work. Kit comes complete with adapter for most applications. Designed to be used for both static and on road testing.

Features and benefits:

- Large 3-1/2" gauges feature a chrome bezel and rugged protective outer boot.
- Low pressure gauge reads 0-100 psi and 0-700 kPa.
- High pressure gauge reads 0-400 psi and 0-2800 kPa.
- Both gauges include rear hook to allow gauge to be hung conveniently out of the way.
- Gauges and hose assembly incorporate quick couplers for easy disconnect.
- Kit includes 13 adapters and a detailed instruction manual.
- Blow molded hard case with removable lid.



**6792
Transmission Fluid
Fill/Extract Kit with Adapters**

Designed for undercar transmission fluid service. The 6-liter sealed reservoir is used with shop air to extract or dispense transmission fluid with a simple control valve. A safety relief valve ensures safe operation. Includes a general universal adapter and storage case with 14 OE-style adapters with easy to read application information. Adapters cover most vehicles. All connections are simply press-on quick connects for ease of use. Pictorial operating instruction decals are on the reservoir - keeping important how to and safety information with the product.

**6792-EDB
Extraction Dispenser Bottle**

- Connect to shop air supply to extract or dispense fluids
- Automatic pressure relief for safe operation
- Switch between Dispensing and Extraction by simple turn of valve
- Easy "Push On" quick connects, and Trigger lock for continuous flow
- Includes universal flexible nozzle

**6792-TFA
Transmission Fluid Adapters**

- 14 piece "OE style" ATF adapters
- Vehicle application reference included
- Convenient storage case



**4528
Clutch Alignment Tool Set (17 piece)**

- Essential for clutch installation on virtually all cars and light-duty trucks. Aligns clutch plate by using tapered cones and pilot adapters.
- Includes seven fractional pilot adapters, 1", 13/16", 25/32", 3/4", 11/16", 5/8", 19/32" one clutch disc centering adapter, and one alignment shaft.
- Includes five metric pilot adapters, 19mm, 17mm, 16mm, 14mm, 12mm, two clutch disc centering adapters, and one alignment shaft.
- Housed in a blow-molded storage case.

Similar to Ford 308-182 & Chrysler MLR-6638A



**7646A
Clutch Coupling Tool**

- Disconnects the hydraulic clutch line from the clutch slave cylinder on the following vehicles with manual transmissions and hydraulic clutches: 1988-2012 F-series trucks, Bronco II, Ranger, Explorer, 1989-1997 Ford Thunderbird and Mercury Cougar and 1992-2010 Chrysler PT Cruiser.
- Wedge-shaped design allows easy removal of clutch line without damaging clutch line, coupling, or slave cylinder. No need to pry the coupler apart.

Similar to J-44643.

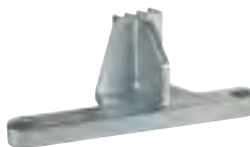

**7221
Flywheel Holder**

- Holds flywheel in a locked position for servicing.
- Fits GM 6.6L Duramax Diesel, 2001 to present.



Similar to Ford T65L-77515-A

**7024
Automatic Transmission
Clutch Spring Compressor**

- This is a handy, adjustable tool for removing or installing the snap ring on a transmission rear clutch piston. It applies pressure to the clutch drum's retaining washer to compress piston return springs.
- For use on most American cars and light trucks.

**6604
Ford Transmission Fluid Fill Adapter**

- Use to fill or add fluid to the automatic transmission.
- Works on the 5R55W transmission in Ford trucks.



Similar to Ford 307-437



**6714
Input Shaft Seal Installer**

Two-function seal installer. One end installs the input shaft seal into the main housing to the proper depth. The opposing end of the installer installs the side extension housing seal to the proper depth. Similar to DT-50840 & J-8092. Applications: 2013-Later Chevrolet Trax and Buick Encore.



**6715
Torque Converter Seal Installer**

Installs torque converter seals without damage in 1990 - 2011 GM 4T60 and 4T60E automatic transmissions found on most GM front wheel drive vehicles. Similar to J-28540-A. Applications: 1990-2011 GM 4T60 and 4T60E automatic transmissions used on most General Motors front wheel drive vehicles, including from Buick, Chevrolet, Pontiac, Cadillac, Oldsmobile.



**6716
Shift Rail Seal Installer**

Installs the shift seal on the Tremec TR 3160 manual transmission to the proper depth to ensure optimal seal life. Includes a removable pilot to allow for use both on-vehicle and during unit repair, with the shift shaft in place or removed. Similar to DT-51077. Applications: 2013 and later Cadillac ATS manual transmission, 2016 and later Chevrolet Camaro, 2016 and later Ford Mustang Shelby GT350



**6702
Transmission Adapter Plate Bushing Replacer**

Replaces the mount bushing on the transmission adapter plate. Adapter has a window for verifying the bushing position during installation, and is deep enough for bushing removal. Similar to DT-50839 & CH-50342. Applications: 2013-Later Chevrolet Trax, Buick Encore



**6724
Trans Mainshaft Bearing and Gear Installer**

Designed for use on 2014 and later Chevrolet Corvette 7-speed manual transmission. Kit contains tools to install mainshaft cone bearing, mainshaft rear support roller bearing inner race, countershaft rear bearing cone, and 3rd, 4th, 5th, 6th, 7th, and Reverse gears. Includes a tube installer with a supplied threaded rod assembly, a double end threaded adapter, and tube adapters. These tools prevent damage to components and are necessary as the transmission assembly cannot be mounted in a press or hammered into place. Similar to DT-51076 & DT-51076-10.



**4508
Professional Style Seal Puller**

- Designed to remove oil and grease seals when servicing cars, SUVs, and light trucks without damaging the housing or bearing.
- Hook tips in two sizes and professional handle design allows removal of hard-to-get-at seals by getting under them.
- The tool is 12" long and the hook tip is double-secured (versus competitors' designs), for durability.
- An extra blade is included, and additional replacements (No. 4508-1) may be ordered.

4508-1 Replacement blade for 4508



Similar to Ford T85T-18539-AH

**519156
Ford and Chrysler Heater Hose Disconnect Tool Set**

- Quickly and easily removes heater hose from heater core tube without damaging coupling retainer or hose.
- This set includes the heater hose disconnect tool for 5/8" and 3/4" heater hoses with quick connect couplings at heater core, and an extension handle for easier access.
- For use on 1986-current Aerostar vans and 1991-current full-size vans, 1987 to current Dodge Caravan and Plymouth Voyager vans.



Similar to Kent-Moore J-38723

**519157
GM Heater Line Quick Connect Separator**

- When you need to get at and release the quick connect fitting that connects the heater hose to the engine block and thermostat housing, this little tool is great for saving time and aggravation.
- Works on 1991-current GM vehicles with 3.1L, 3.4L, and 3800 engines.



Similar to Kent-Moore J-42371, J-36221

**7910
GM Hydraulic Clutch Line Disconnect Tool**

- This is a versatile tool for disconnecting clutch lines when you're working on clutch assemblies or slave and master cylinders. The bent end, intended for NVG3500 and NV4500 manual transmissions, works on 1996 to 2012 full-size 2WD and 4WD trucks, Chevrolet S-10 Blazer, and pickups. The straight end is for 1993 to '94 Chevrolet Lumina sedan, 1995 to 2000 Chevrolet Monte Carlo, 1993 to '99 Buick Regal, 1998 to 2002 Olds Intrique, 1993 to '97 Olds Cutlass Supreme and Pontiac Grand Prix.



**7937
GM Transmission Oil Cooler Line Disconnect Tool**

- Specially designed to work in tight places. So simple to operate, you can do it with just one hand.
- After insertion into the quick-connect fitting on 1/2" dia. lines, a quarter turn of the tool quickly and easily releases the fitting on the transmission end of the transmission-to-radiator oil cooler line.
- Works on 2WD and 4WD pickups and vans with electronic shift overdrive automatic transmissions: 1991- newer 4L80E transmissions, and 1993-newer 4L60E transmissions.

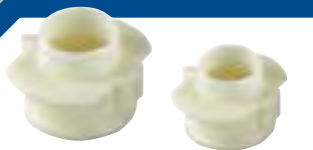

1/2" is similar to Ford 307-459.

3/8" is similar to Ford 307-441.

6593

Ford Transmission Cooler Line Disconnect Set

- Tool snaps around cooler line and, when pushed into the fitting, releases the fitting. The cooler line can then be removed.
- 3/8" disconnect is used on 2003–newer Ford Explorers with the 5R55W transmission.
- 1/2" disconnect is used on 2003–newer Ford Super Duty trucks with the 4R100 transmission.

Similar to Kent-Moore J-44822



6611

Transmission Line Disconnects

- Used on 2001 to current Chevrolet Corvette with the 4L60E transmission, and 2003 to current Cadillac CTS with the 5L40E transmission.
- 6 per pack.

6579

Transmission Disconnect (2 pack)

- Designed to disconnect transmission lines on Ford Taurus/Explorer 2005 and newer.
- Similar to OE p/n 307-569.



6517

Disconnect Tool Set

Designed for A/C lines, fuel lines, and transmission cooler lines.

- Contains 3/8", 1/2", 5/8", and 3/4" spring lock disconnect tools for A/C lines on Ford cars and trucks, Chrysler and Jeep vehicles.
- Contains the 3/8" and 1/2" fuel line disconnect tool for Ford vehicles.
- Contains the 5/16" and 3/8" fuel line disconnect tools for GM and Chrysler vehicles.
- Contains the transmission oil cooler line disconnect tool used on many GM and Ford vehicles.



519154

Ford Fuel Line Disconnect Tool Set

Here's the best tool for easy, frustration-free fuel line separation. As you put the tool on the fuel line coupling, its fingers depress the retaining collar to release the fuel line, preventing component damage.

- Works on 1990 to 1995 Ford Ranger and Explorer models fitted with 4.0L, 6-cylinder engines.



See page 27 for complete details.

6508

Full-Coverage Disconnect Tool Set

If you're working on Chrysler, Ford, or General Motors vehicles, this set can make your job easier.



6703-3

6703-1

6703-2

6703

Line Fluid Stopper Kit

- Kit seals all types of rubber and steel line found on fuel, brakes, AC, power steering and transmission system.
- Includes two banjo style fitting stoppers, two steel line stoppers, six line plugs, a line disconnect tool, and a long reach line pinch-off tool for hard-to-reach hoses.

6703-1 Banjo Line Fluid Stoppers, 2 pk.

6703-2 Steel Line Fluid Stoppers, 2 pk.

6703-3 Line Plug Fluid Stoppers, 6 pk.

Transmission Line Disconnect Tools



519152 Oil cooler line disconnect tool.



519153 Clutch coupling tool.



519159 Transmission oil line tool



519378 Chrysler/Jeep oil cooler line disconnect tool



6511 3/8" & 1/2" Fuel line disconnect tool



8101

8100

Fluid Evacuation / Brake Bleeding Tools

- Use to bleed brake systems and remove a variety of fluid from vehicles, such as antifreeze, oil, transmission fluid, gear lube, etc.
- Quick connect locking hose adapters and ball-style on/off valve on hose prevent fluid leakage.
- Equipped with a relief valve to prevent over-pressurizing the tank.

8100

Operates by shop air or a hand pump; shipped complete with a brake bleeding hose, fluid evacuation hose, and two suction hoses (6 mm and 7 mm); 10-liter capacity tank.

8101

Operates with shop air; shipped with a brake bleeding hose and fluid evacuation hose; 6-liter capacity tank.



4848

Flexible Spout Funnel

Many oil, transmission, and coolant fluid fill caps are located in hard to access areas. This aluminum 5 1/2" funnel features a removable debris screen in the base flowing to a 25" flexible spout designed to reach these difficult fill locations.

6514

Mini Tubing Cutter

- Works on tubing sizes 1/8" to 5/8" O.D. (3mm to 16mm).
- Easily cuts copper, brass, aluminum, and steel brake lines in hard-to-reach places.
- Extra cutting wheel stored in knob.



6512

Heavy-Duty Tubing Cutter

- Works on tubing sizes 1/8" to 1-1/8" O.D. (3mm to 29mm).
- Easily cuts copper, brass, aluminum, and steel brake lines.
- Reamer folds onto cutter body for storage.
- Extra cutting wheel stored under reamer.





4422
Pilot Bearing Puller

- Use to pull a pilot bearing from the end of the crankshaft.
- A restriction plate catches the bridge and prevents the jaws from spinning when force is engaged.
- The "Tee Handle" design is easy-to-use and eliminates need for other tools.
- Spread covers ranges of 1/2" to 1-1/2".
- Reach has a min/max range of 3/16" to 1".



4420
Pilot Bearing Puller Attachment

- Use to pull a pilot bearing from the end of the crankshaft.
- Interchangeable jaws. One set of jaws covers a spread of 1/2" to 1-1/2". Other set of jaws covers a spread of 3/8" to 1-3/8". Both sets of jaws have a reach of 1".
- Reach has a min/max range of 3/16" to 1".
- Puller attaches to OTC and other slide hammers with 5/8"-18 thread.



4421
Pilot Bearing Puller Attachment

- Removes pilot bearings, thrust washers, and smaller bearings hidden in a shaft or housing.
- Jaws require a minimum of 5/8" opening and can range up to a max of 1-1/2" diameter.
- Min/Max reach is 1/8" to 1".
- Works with both 5/8-18 as well as M18-1.5 threaded hammer shanks.



Fed. Spec.: GGG-W-665b

885
Adjustable Hook Spanner Wrench

Here's a tool that's needed wherever turret adjusting nuts or packing gland nuts are used.

- Capacity is 1-1/2" to 4".
- Handle is 24" long, 11/16" diameter.



Gear and Pulley Pullers

These tools are perfect for removing timing gears, fan pulleys, harmonic balancers, and many other parts having tapped holes.

- Each puller will spread from 1-1/2" to 4-1/4". The puller blocks are 4-7/8" wide, tapped 5/8" - 18 UNF.
- Both include two hex head cap screws, 3/8"-16 x 3" long.

7392 Puller with 13" long screw.

7393 Puller with 5-1/2" long screw.



7118
Transmission Adapter Kit

Converts your OTC engine stand into a transmission service stand.

- Kit replaces the adjustable arms of the stand to hold and position the transmission at workbench height for repair.
- The transmission is held with three sides fully exposed for working convenience, and can be rotated a full 360° for complete access to all parts.

Pilot Bearing Pullers

Designed to pull flywheel pilot bearings in close quarters where a slide hammer cannot be used. Operates on many models with engine in chassis.



7318

7318
Pilot bearing puller. Capacity: 1/2" to 1-1/2". I.D. reach: 3/4".

7319
Pilot bearing puller. Capacity: 7/8" to 2". I.D. reach: 1".

Similar to Ford D80L-522-A, 303-D025



522
Large Gear and Pulley Puller

Using this tool, you can easily remove a wide range of gears, pulleys, or other parts that have tapped holes.

- The puller will spread from 2" to 7-3/4". Its block is 8-1/4" wide, and its forcing screw is 3/4" - 16 x 11-5/8" long.
- Accommodates any cap screws up to 1/2" diameter.



7040-1

7040
Trans Case Holding Fixture

This holding fixture has an adjustable design for adapting to multiple transmission case configurations and other components. Safety handles components up to 250 lbs and offers 360-degree rotation with positive stops at 90-degree increments. Includes 7040-1 fixture and 34607 base. Similar to J-36842.

7040-1 For use with base p/n 34607.



7020 Similar to Ford T57L-500-B, 307-003

7020
Bench-Mounted Holding Fixture

Here's a helpful device that enables you to securely hold and rotate small engines, transmissions, and other components while you're working on them.

- This holding fixture will handle pieces weighing up to 250 lbs., and it offers 360° of rotation with positive stops at 90° increments.
- Three sides of the mounted unit remain fully exposed.

34607
Base assembly only.

34607 Similar to Ford D83L-500-B1, 300-D041



Similar to EN-50792.

6759
Flywheel Holding Tool

Holds the flywheel in place for servicing the balancer or flywheel bolts. Mounts in place of the starter and engages the flywheel ring gear teeth. Applications: 2013-14 Cadillac ATS, 2014 Cadillac CTS, 2013-14 Chevrolet Malibu, 2014 Chevrolet Impala & Buick Regal 2.0L, 2.5L engines.

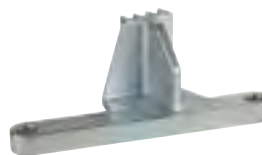

Similar to J-44643

7221
Flywheel Holder

- Holds flywheel in a locked position for servicing.
- Fits GM 6.6L Duramax Diesel, 2001 to present.



4543A Locknut Socket Set – 4WD (6 piece)

- Chrome vanadium steel sockets cover most SUV and light truck applications.
- Sockets have 1/2" square drive, allowing use of a torque wrench, ratchet, or breaker bar.

Contents of set:

- 4543A-1 Toyota 4-lug locknut socket.**
Services high-torque locknuts on Toyota 4WD vehicles having free-wheel (lock out) hubs: 1995–newer Tacoma; 1996–newer T100 and 4Runner.
- 4543A-2 Ford 4-lug locknut socket** for high-shear rotating nuts on 1985–newer F-250 and F-350 truck rear axles, and Dana 80 rear axles of Ford Super Duty trucks.
- 4543A-3 4-lug socket** for removing and installing 4-slot front axle locknuts on 1986–newer F-Series 1/2-ton trucks, full-size Bronco with Dana 44 axle, 1984–92 Ford Ranger, and Bronco II with manual hubs. Also, Dodge trucks using Dana 44 axle with automatic hubs.
- 4543A-4 6-lug socket** for removing and installing 4-slot front axle locknuts on 1978–84 Ford F-Series 4WD heavy-duty 3/4- and 1-ton trucks; 1973–81 GM 4WD 3/4- and 1-ton trucks.
- 4543A-5 4-lug socket** for removing and installing 4-slot front axle locknuts on 1993–newer Ford Ranger, Bronco II, and Explorer with manual hubs; 1995–newer F-Series 1/2-, 3/4-, and 1-ton trucks and full-size Bronco with manual hubs; 1959–85 F-Series 1/2- and 3/4-ton trucks and full-size Bronco; 1960–90 GM 1/2-ton trucks and full-size Blazer/Jimmy; 1969–72 International 1/2-ton trucks; 1969–89 Dodge 1/2-ton trucks with manual hubs.
- 4543A-6 FWD front spindle puller** Removes front spindle to access needle bearing, when lubricating and aligning front wheels. 5/8"-18 fine thread permits use with OTC No. 1155 slide hammer. Fits spindle thread sizes 2"-16, 1-5/8"-16 and 38 mm-1.5. Applications: Full-size GM, Ford, Jeep, and International pickups with Dana front axles, plus Ranger and Bronco II.

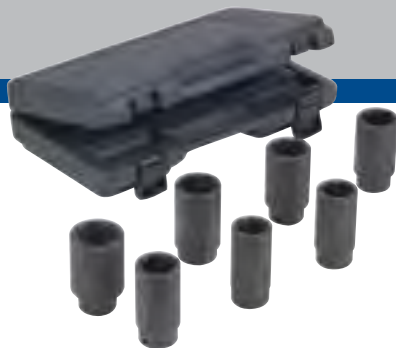

4547A Axle Nut Socket Set – FWD (7 piece)

- Extra long, 1/2" drive chrome molybdenum sockets for heavy-duty use in removing/installing axle nuts.
- Use with a ratchet, breaker bar, or torque wrench.
- Contained in a blow-molded plastic storage case.

Contents of set:

- 4547A-29** 29 mm FWD axle nut socket.
- 4547A-30** 30 mm FWD axle nut socket.
- 4547A-32** 32 mm FWD axle nut socket.
- 4547A-34** 34 mm FWD axle nut socket.
- 4547A-35** 35 mm FWD axle nut socket.
- 4547A-36** 36 mm FWD axle nut socket.
- 4547A-38** 38 mm FWD axle nut socket.



4542 7-Piece Wheel Bearing Locknut Socket Set

- For use with 1/2" ratchet or breaker bar.

Contents of set:

- 519097-1 2-3/8" hex locknut socket** works on 1984–92 Ford Rangers and Bronco IIs with automatic locking hubs. Similar to Ford 205-040 (T70T-4252-B).
- 519097-2 2-9/16" rounded hex locknut socket** works on 1990–93 Dodge trucks with Dana 60 manual hubs.
- 519097-3 2-1/2" hex locknut socket** fits the hex nut found on rear axles and various front axle applications on light-duty trucks.
- 519097-4 2-3/4" rounded hex locknut socket** works on 3/4-ton and 1-ton Ford F-250 and F-350 trucks with automatic locking hubs. Similar to Ford No. 205-349 (T95T-1197-B).
- 519097-5 2-1/2" rounded hex locknut socket** works on 1995–96 Ford F-150 trucks and full-sized Broncos with automatic locking hubs. Similar to Ford 205-348(T95T-1197-A).
- 519097-6 2-3/8" rounded hex locknut socket** works on 1990–newer Ford Rangers, Bronco IIs, and Explorers with automatic locking hubs.
- 519097-7 55 mm hex locknut socket** designed for use on front wheel adjusting nuts found on Toyota models FJ, LN, and RN.

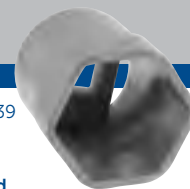

Similar to Ford 205-039 (T70T-4252-B)

1902 Locknut Socket - Ford Drive 3/4" (6 pt.) 2-3/8" Hex

- This high-grade truck wheel bearing locknut sockets are made of high-strength steel and resist rounding out.
- Services 1984–92 Ford Ranger and Bronco II with automatic hubs; 1993–1997 Ford Ranger, Bronco II, and Explorer with automatic hubs.
- For manual use only, impact wrench voids warranty.

Similar to Ford 205-043 (T70T-4252-W)

Fits special "rounded" hex nut found on Dana axles of some Ford trucks. Depth of locknut sockets is 5".



1928 Locknut Socket - Ford, Dodge Drive 3/4" (6 pt.) 2-9/16" Hex

- This high-grade truck wheel bearing locknut sockets are made of high-strength steel and resist rounding out.
- Services 1990–93 Dodge truck with Dana 60 manual hubs. 3/4" sq. drive.
- For manual use only, impact wrench voids warranty.

Fits special "rounded" hex nut found on Dana axles of some Ford trucks. Depth of locknut sockets is 5".

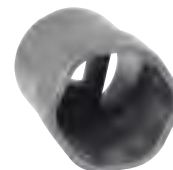

1936 Locknut Socket - Ford Drive 3/4" (6 pt.) 2-3/8" Hex

- This high-grade truck wheel bearing locknut sockets are made of high-strength steel and resist rounding out.
- Services 1990–newer Ford Ranger, Bronco II, and Explorer with automatic hubs.
- For manual use only, impact wrench voids warranty.

7269 Locknut Socket Ford, GM

- Services 1985–newer Ford F-series 3/4- and 1-ton trucks with Dana 80 rear axle.
 - 1/2" sq. drive.
- Similar to Ford 205-282 (T88T-4252-A) Kent Moore J-42855



2-3/4"

6601 Locknut Socket - Ford

- Services 2003–newer Ford F-250, F-350, and F-450 Super Duty trucks with 10-1/2 inch rear axle.
 - 1/2" sq. drive.
- Similar to Ford 205-448



2-3/4" O.D.

2-1/4"



7157

Locknut Socket Ford, Dodge, GM

- Services 1993–newer Ford Ranger Bronco II and Explorer with manual hubs; 1995–96 Ford F-series 1/2-ton truck and full-size Bronco with manual hubs; 1995–newer Ford F-series 3/4-ton and 1-ton trucks with manual hubs; 1959–85 Ford F-series 1/2- and 3/4-ton trucks and full-size Bronco; 1960–90 GM 1/2-ton truck and full-size Blazer/Jimmy; 1969–89 Dodge 1/2-ton truck with manual hubs; 1969–72 International 1/2-ton truck.
- 1/2" sq. drive.

Similar to Ford 205-192 (T83T-1197-B)

7158

Locknut Socket Ford, Dodge, GM

- Services 1985-1/2–95 Ford F-series H.D. 3/4- and 1-ton Dana 50 IFS of Dana 60 front axle; 1982–90 GM H.D. 3/4- and 1-ton trucks, 1994–newer Dodge Dana 60 with Cummins.

- 1/2" sq. drive.
- Similar to Ford 205-D065 (D85T-1197-A)



2-1/2"

6006

Locknut Socket - Dodge

- Services 1994–newer Dodge 1/2-ton 4x4 pickups with Dana 44 front axle and Dana 60 axle with vacuum disconnect front axle.

- 1/2" sq. drive.



1-11/16" 43 mm

7612

Locknut Socket Toyota

- 54 mm hex socket fits front wheel bearing adjusting nut of Toyota FJ, LN, and RN. Has 1/2" square drive end, permitting use of a torque wrench.

- 1/2" sq. drive.



2-1/8" 54 mm

7698

Locknut Socket Isuzu, Honda, Jeep

- Services 1988–1995 Isuzu Trooper, Rodeo, Amigo, and pickup; 1989–1995 Honda Passport; Jeep J20 pickups with Dana 60 axle.

- 1/2" sq. drive.



2-1/4"

7795

Locknut Socket Ford

- Services 1995–1996 Ford F-series 1/2-ton trucks and full-size Bronco with automatic hubs.

- 1/2" sq. drive.

Similar to Ford 205-348 (T95T-1197-A)



2-1/2"

7796

Locknut Socket Ford

- Services 1995–1998 Ford F-series 3/4- and 1-ton trucks with automatic hubs.

- 1/2" sq. drive.

Similar to Ford 205-349 (T95T-1197-B)



2-3/4"

7941

Locknut Socket Toyota

- Specially designed to fit 4WD lock-out hubs on Toyota's 1995–2002 Tacoma, and 1996–2002 T100 and 4Runner.

- 1/2" sq. drive.

Similar to Toyota 09318-12010-01.



2.366 center to center on pins

7090A

Locknut Socket Ford, GM

- Services 1978–84 Ford F-series H.D. 3/4- and 1-ton 4WD trucks; 1973–81 GM 3/4- and 1-ton 4WD trucks.

- 1/2" sq. drive.

Similar to Ford 205-D001 (D78T-1197-A)

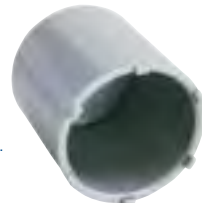

2-5/8"



2-3/8"

7270A

Locknut Socket Ford, Dodge

- Services 1984–92 Ford Ranger and Bronco II with manual hubs; 1986–95 Ford F-series 1/2-ton truck; full size Bronco with Dana 44 front axle; 1990–93 Dodge trucks with Dana 44 automatic hubs.

- 1/2" sq. drive.

Similar to Ford 205-244 (T86T-1197-AR)



6612, 6921

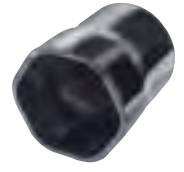

6796, 6928

6612 54 mm hex locknut socket designed for use on front wheel adjusting nuts found on Toyota FJ, LN, and RN models.

6921 2-1/2" hex locknut socket its hex nut found on rear axles and various front axle applications on light-duty trucks.

6796 2-3/4" rounded hex locknut socket. Works on 3/4- and 1-ton Ford F-250 and F-350 trucks with automatic locking hubs. (Ford No. T95T-1197-B & 205-349).

6928 2-9/16" rounded hex locknut socket. Works on 1990–93 Dodge trucks with Dana 60 manual hubs.

7217

Axle Nut Socket

- Designed to fit the axle nut on Chevy Topkick/Kodiak, 2003 - Newer.
- Similar to J-44275.



7218

Axle Hub Nut Socket

- Removes/installs the axle hub bearing retaining nut.
- Fits GM 11-1/2" rear axle found on 2011 and newer trucks.
- 9 Pin socket, 1/2" drive.
- Similar to CH-50636.



DRIVE AXLE SERVICE AUTOMOTIVE SPECIALTY TOOLS



6694 Axle Seal Installer

- Designed to install the axle seal on GM Trucks with 10-1/2" ring gear.
- Similar to J-24428-A.



7248 C-Frame Press

The C-Frame used in conjunction with OTC Ball Joint Adapters. Can also be used for removing/installing; universal joints with needle bearings, pressed in wheel studs, and brake anchor pins on heavy-duty vehicles. Suitable for general pressing operations.



7917 Live Center Forcing Screw Plug

This plug replaces the existing forcing screw on the No. 7248 C-frame to allow its use on heavy-duty ball joints. The shorter length gives the C-frame a wider opening to accommodate the larger ball joints on 3/4- and 1-ton trucks.



6935 U-Joint Service Adapter

For use with the 7248 C-Frame to service the u-joints found on Dana 60 4WD front drive axles.

Application Examples:

- 1977-1991 Chevrolet and GMC 1 Ton
- 1975-2010 Dodge 3/4 and 1 Ton
- 2000-2002 Ford Excursion
- 1999-2010 F250
- 1985-2010 F350
- 1999-2008 F450
- 1999-2004 F550



6541 Pulling Hook

- This slide hammer puller attachment is used to remove seals, bearings, and other press-fit parts.
- Designed to be used with OTC No. 1155 (5 lb.) or No. 1156 (2-1/2 lb.) slide hammer, or other slide hammers having 5/8-18 threads.



7792 Rear Axle Service Set

The tools you need for flange-type rear axle and bearing removal on most late model passenger cars and light trucks. The axle bearing pullers, used with the slide hammer, make short work of removing semi-floating rear axle bearings. Consists of:

- 7374** Rear axle pulling plate with 5 lb. slide hammer.
- 7495A** Rear axle bearing puller. Fits min. bearing tube I.D. of 1" and max. axle tube I.D. of 1-7/8".
- 7496A** Rear axle bearing puller. Fits min. bearing tube I.D. of 15/16" and max. axle tube I.D. of 2-3/8".
- 7497A** Rear axle bearing puller. Fits min. bearing tube I.D. of 1-3/8" and max. axle tube I.D. of 2-7/8".
- 27315** Puller hook for use with the 5 lb. slide hammer. Removes oil seals, bearings, etc.



6540 Rear Axle Bearing Puller Set

- Set contains slide hammer and popular attachments needed for servicing flange-type, floating rear axle bearings and seals in most late model, rear-wheel drive cars and light trucks; comes in a molded case.
- Rear axle bearing puller fits min. bearing tube I.D. of 1" and max. axle tube I.D. of 1-7/8".
- Rear axle bearing puller, fits min. bearing tube I.D. of 1-5/16" and max. axle tube I.D. of 2-3/8".
- Rear axle bearing puller fits min. tube I.D. of 1-3/8" and max. axle tube I.D. of 2-7/8".
- Slide hammer tee bar, slide hammer 5 lb. weight, pulling hook, rear axle pulling plate, bearing cup remover.



Slide Hammer Rear Axle Puller

This puller will enable you to remove flange-type rear axles from most late model cars and light trucks. It works on axles having bolts and studs up to 9/16" diameter.

- Fits 4-, 5-, or 6-bolt patterns and stud circles from 4-1/4" to 5-9/16".
- 7372** Rear axle pulling plate.
- 7374** Rear axle pulling plate with 5-lb. slide hammer assembly.



7494A Rear Axle Bearing Service Set

Designed to make the removal of semi-floating rear axle bearings easier. Allows you to capture the bearing firmly, distributing the pulling force over the entire bearing. This reduces damage and increases the amount of applications. Set includes three pullers to service most domestic cars. Use with OTC Nos. 1155 or 1156 slide hammer with 5/8"-18 UNF thread. Pullers also available separately.

- 7495A** Rear axle bearing puller. Fits minimum bearing tube I.D. of 1" and maximum axle tube I.D. of 1-7/8".
- 7496A** Rear axle bearing puller. Fits minimum bearing tube I.D. of 1-5/16" and maximum axle tube I.D. of 2-3/8" including 1988-2000 Chevrolet and GMC 8-1/2", 1/2-ton rear axle bearing.
- 7497A** Rear axle bearing puller. Fits minimum bearing tube I.D. of 1-3/8" and a maximum axle tube I.D. of 2-7/8".

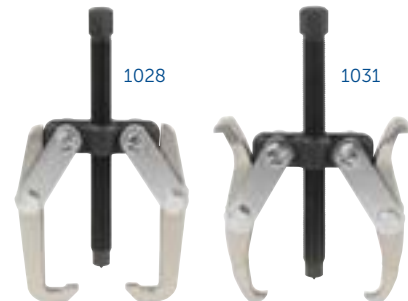

Differential Bearing Pullers

For removing differential side carrier bearings on a wide variety of passenger cars and light trucks. Use with step plate adapter Nos. 8060, 8061, 8063, and 8064. (Step plate adapters are not included with 1028 or 1031. See page 125.)

- 1028** Puller with a 3-1/2" maximum reach, 1-1/4" to 4-1/2" spread. Primarily for servicing Ford products.
- 1031** Puller with a 3-1/4" maximum reach, 6" maximum spread. For servicing most General Motors, American Motors, and Chrysler products.



6602 Differential Bearing Preload Wrench

- Use to adjust differential bearing free play on Chrysler/Dodge vehicles with 7-1/4", 8-1/4", 8-3/4", and 9-1/4" rear axles.
- Tool fits inside axle tube to access the threaded adjusters.



4520

Differential Side Bearing Pullers

- Use to remove differential side carrier bearing. Works on a wide variety of cars and light-duty trucks.
- Includes four step plate adapters to fit carrier bearings.
- Reach: 1-5/8". Spread: 2-5/8" to 3-3/8". Forcing screw is 3/4"-16 x 6-11/16" lg.
- Set includes:

4520-1 Forcing Screw / Cross Block Assembly

4520-2 Puller Jaws / Pins (set of two each)

4520-3 Puller Jaws Retaining Yoke

4520-4 Step Plate Adapters (set of four)

- 15/16" - 1-11/32" diameter,
- 1-1/8" - 1-1/2" diameter
- 1-1/4" - 1-5/8" diameter,
- 1-1/8" - 1-3/4" diameter

Specifications

Reach: 1-5/8"
Spread: 2-5/8" on inside holes in crossbar
3-3/8" on outside holes in crossbar
Forcing screw: 3/4"-16 mm x 6-11/16" lg.
Adapter sizes: 15/16" to 1-3/4" diameter



4508

Professional Style Seal Puller

- Designed to remove oil and grease seals when servicing cars, SUVs, and light trucks without damaging the housing or bearing.
- Hook tips in two sizes and professional handle design allows removal of hard-to-get-at seals by getting under them.
- The tool is 12" long and the hook tip is double-secured (versus competitors' designs), for durability.
- An extra blade is included, and additional replacements (No. 4508-1) may be ordered.

4508-1 Replacement blade for 4508



7140

Ford Half-Shaft Remover/Differential Rotator

No. 7140 is essential when removing the left-hand half-shaft from Escort/Lynx transaxles. It ensures correct removal and allows the technician to turn the differential.

Similar to Ford D80L-522-A, 303-D025

522

Large Gear and Pulley Puller

Using this tool, you can easily remove a wide range of gears, pulleys, or other parts that have tapped holes.

- The puller will spread from 2" to 7-3/4". Its block is 8-1/4" wide, and its forcing screw is 3/4"-16 x 11-5/8" long.
- Accommodates any cap screws up to 1/2" diameter.



7392



7393

Gear and Pulley Pullers

These tools are perfect for removing timing gears, fan pulleys, harmonic balancers, and many other parts having tapped holes.

- Each puller will spread from 1-1/2" to 4-1/4". The puller blocks are 4-7/8" wide.
- Both include two hex head cap screws, 3/8"-16 x 3" long.

7392 Puller with 13" long screw.

7393 Puller with 5-1/2" long screw.



7508

7507

5/8" x 18 thread

Inner CV Joint Puller

This is the puller needed to remove inner CV joints that are held in with axle shaft retaining rings. The slide hammer feature allows removal of the axle assembly from the transaxle without causing damage to the aluminum transmission case or other components. Damage can result by using other prying methods.

7507 CV Joint Fork. Used with No. 1155 Slide Hammer, No. 7508 Slide Hammer Extension, or both.

7508 Optional 17-1/2"-long Slide Hammer Extension.

7509 Inner CV Joint Puller. Includes No. 1155 Slide Hammer and No. 7507 CV Joint Fork.



7509



Similar to Ford 204-D020 (D93T-3206-A)

7502

4WD Front Spindle Puller

This puller enables you to remove the front spindle on light-duty 4WD trucks. It's designed for full-size Ford, GM, International, and Jeep pickups with Dana front axles. Also works on Ford Ranger and Bronco II.

- 5/8" fine thread makes it ideal for use with our No. 1155 slide hammer.
- Fits spindle thread sizes 2"-16, 1-5/8"-16 and 38 mm-1.5.



6712

Axle Seal Protector (10 pack)

Protects seal from being cut or nicked, both of which can cause immediate or eventual leaks. Similar to J-44394-A.

Applications: 2011 and later drive axles on most GM vehicles



6713

Seal Protector

Protects the transfer case Intermediate Drive Shaft (IDS) seal from the splines of the IDS during shaft removal or installation. Similar to DT-50937. Applications: 2013-Later Chevrolet Trax, Buick Encore.



6723

Inner Pinion Bearing Race Installer

Installs inner pinion bearing race to desired position on 1998 - 2006 Chevrolet Suburban and Tahoe. Similar to J-45870 & J-8092.



4722
Heavy-Duty CV Boot Clamp Installer

- Designed to clamp the ear-type CV boot clamps used on front-wheel drive vehicles.
- May also be used to crimp the clamps used on fuel and cooling system hoses.
- Ensures even, precise crimping, and eliminates possibility of damage to the clamp, boot, or hose.



4623
CV Joint Banding Tool and Cutter

- Use to install and tighten the "band-it" or strap style clamps on CV joint boots, or on power steering rack and pinion steering gear boots.
- Once installed into the tool, tighten the band by turning the handle on the tool; use a socket or wrench on the handle to torque the band to OE specifications.
- When the boot clamp has been tightened to specs, cut the band to the correct length by flipping the lever (at the front of the tool) forward.



4724
CV Boot Clamp Pliers

- Special tips work on the ear-less type CV boot clamps.
- Grips clamp in many positions to tighten clamp around boot.

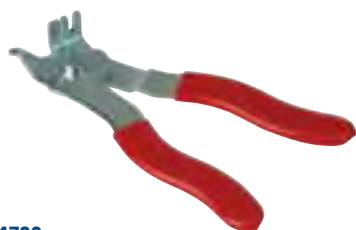

4720
Boot Clamp Pliers – Chrysler

- Required tool for correct installation of strap-and-buckle style CV boot clamps.
- Works on A.C.I. and G.K.N. boots found on various Chrysler, Plymouth, and Dodge front-wheel drive vehicles.
- Prevents damage to CV boot and clamp during installation.

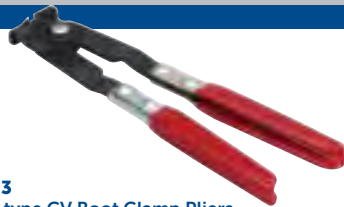

4723
Ear-type CV Boot Clamp Pliers

- Designed to crimp the ear-type CV boot clamps used on front-wheel drive vehicles.
- May also be used to crimp the type of clamps used on fuel and cooling system hoses.
- Ensures even, precise crimping, and eliminates possibility of damage to the clamp, boot, or hose.



4721
CV Boot Clamp Cutter

- Designed to easily cut the CV boot clamp without damaging the boot.
- Will cut boot clamps up to 10 mm wide and .7 mm thick.
- Handles are spring loaded to the open position to allow easy access to the clamp.

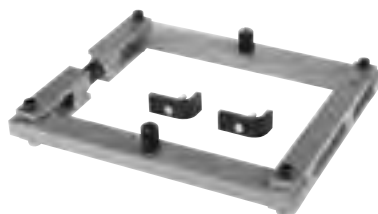

7011
Differential Housing Spreader

Here's a tool that eases the job of removing or installing differential ring-gear assemblies on Dana axle models 30 through 70. It's a heavy-duty device using mechanical screw power to spread the housing. It helps prevent the component damage that often results from the use of homemade devices.

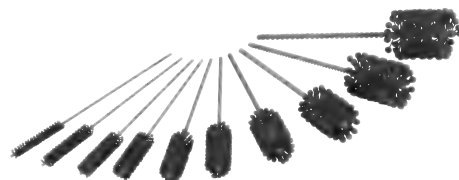

7011
Ball Hone Set, 10 piece

- Ball Hones can be used for refinishing and resizing bores such as found in brake calipers, engine lifters, and u-joint yokes. Also useful for any bearing or bushing application.
- All hones are 180 grit Silicone Carbide for excellent cutting and finish.



Fluid Evacuation / Brake Bleeding Tools

- Use to bleed brake systems and remove a variety of fluid from vehicles, such as antifreeze, oil, transmission fluid, gear lube, etc.
- Quick connect locking hose adapters and ball-style on/off valve on hose prevent fluid leakage.
- Equipped with a relief valve to prevent over-pressurizing the tank.

8100 Operates by shop air or a hand pump; shipped complete with a brake bleeding hose, fluid evacuation hose, and two suction hoses (6 mm and 7 mm); 10-liter capacity tank.

8101 Operates with shop air; shipped with a brake bleeding hose and fluid evacuation hose; 6-liter capacity tank.



4295
Wheel Stud Service Kit

- Works on most hubs for installation/removal.
 - All sizes of studs.
- Installation done by pushing on the head, eliminating the need for threaded adapters.
 - Reduces number of adapters required
 - Reduces damage to studs
 - Increases ease of use
- Remove and install 10 studs in only 10-15 minutes (compare to 20-30 minutes for more expensive competitive products).
- Can be powered with an impact wrench, no hydraulic power source required.
- No need to remove hub from vehicle.
- Reduces risk of damage to hubs, studs, and bearings when using tool.
- Weighs only 12 lbs., assembled to remove studs and 14 lbs., assembled to install studs.

Tool No.	Size
7011-1	.375" 10 mm
7011-2	.500" 13 mm
7011-3	.625" 16 mm
7011-4	.750" 19 mm
7011-5	.875" 22 mm
7011-6	1.00" 25 mm
7011-8	1.25" 32 mm
7011-10	1.50" 38 mm
7011-12	1.75" 44 mm
7011-14	2.00" 51 mm

STEERING

Pitman Arm Pullers 56 – 57
Separator Tools 57
Pickle Forks 57
Inner Tie Rod Tools 58
Power Steering Pumps 59
Steering Wheel Pullers 60
Flange-Type Pullers 60

SUSPENSION

Strut Compressor 61
Ball Joint Tools 62 – 64
Ball Joint Separators 64
Torsion Bars 65
Alignment Tools 65 – 66
Strut Tools 67

HUB

Hub Grappler™ 68
Hub Pullers 69
Hub Resurfacing Kit 70
Slide Hammer Puller Sets 70 – 71
Locknut Sockets 71 – 72



6295 Front End Service Set

Kit includes five popular tools used for servicing Pitman arms, ball joints, and tie rods on most vehicles.

Set includes:

- 7314A – Pitman arm puller.
- 7315A – Tie rod end remover.
- 7503 – Outer tie rod remover/ball joint separator.
- 6296 – Pitman arm/tie rod end puller.
- 6297 – Ball joint separator.



7314A Pitman Arm Puller

This puller will handle nearly any Pitman arm job on passenger cars and light trucks. It features special forged jaws shaped to fit the job, ensuring a positive grip every time. Spread between jaw tips: 1-5/16".

7315A Tie Rod End Remover

Redesigned to use on imports and many front wheel drive vehicles, including SUVs with rack and pinion steering. Live center tip on forcing screw swivels to align tool to tie rod stud to ease in removal and prevent damage to stud. Similar to Ford 211-001 (TOOL-3290-D)



6496 Pitman Arm Puller

Cuts Removal Time from 3 1/2 Hours to 40 Minutes

- Labor intensive removal of steering sector not necessary.
- Compact design allows easy access to the Pitman arm.
- Works on most domestic SUVs and pickups.
- Live center on forcing screw and use of a standard wrench results in less effort required.
- Tool is forged steel for durability and long life.



6296 Pitman Arm/Tie Rod End Puller

The versatile design allows this tool to be used as a Pitman arm remover for many small, domestic rear wheel drive vehicles, or as a tie rod end puller for many domestic and import vehicles. The jaws, with a spread of 1", give a positive grip in tight work places.



6297 Ball Joint Separator

This tool is used to separate the ball joint from the spindle support arm. It works on many domestic and import front wheel drive vehicles, and is adjustable up to 2" for different size ball joints.



7503 Outer Tie Rod Remover/Ball Joint Separator

This tool is a must when you're servicing outer tie rods and ball joints. It works on imported and domestic models, front or rear wheel drive, cast or stamped-steel steering knuckles.

- Handles up to 5 tons of force.
- Jaws spread to 3" and has a 4" reach.
- Jaws, once tightened, won't slip on the knuckle.



Works on the following four-wheel-drive vehicles

1998 – 2003	Ford Navigator
1997 – 2004	Ford F-150 and Expedition
1991 – 2004	Oldsmobile Bravada
1992 – 2011	Chevy Suburban
1988 – 2005	S-10 / S-15 GMC Trucks & Chevy Blazers
1988 – 2011	GMC & Chevy 1/2, 3/4, & 1 ton pickups
1995 – 2011	Chevy Tahoe and GMC Yukon/Denali

6497 Super-Duty Pitman Arm Puller

- Works on 2005 and newer Ford F-250 and F-350 four-wheel-drive Super Duty trucks.
- Allows the Pitman arm to be removed from the steering gear while the steering gear is still in the vehicle.
- Two clamp bolts lock the jaws on the Pitman arm, ensuring a solid grip.
- Maximum jaw spread is 3-1/4".



7311A Similar to Ford No. 211-003(T64P-3590-F)

Pitman Arm Pullers

These pullers are designed for the toughest Pitman arm jobs. They're adjustable and have rugged forged jaws shaped to fit the job. Two clamp bolts lock the jaws on the Pitman arm, ensuring a solid grip. Puller No. 7310A includes an adapter for added versatility. Both pullers cover a variety of pulling jobs.

7310A

Pitman arm puller for medium- and heavy-duty trucks. Max jaw spread: 2-1/4".

7311A

Pitman arm puller for cars and light trucks to 3/4 ton. Max jaw spread: 2-1/8".





8149
Pitman Arm Puller

The 8149 conical tool is designed to fit Pitman arms on compact and intermediate cars.

- Conical design gives increased strength, stability, and fits securely on a Pitman arm.
- Spread is 1-1/4" with a reach of 2-1/4".
- 3/4-16 x 4-3/4" forcing screw provides enough power to remove stubborn Pitman arms.

8150
Pitman Arm Puller

The No. 8150 conical tool is designed to fit Pitman arms on domestic cars and light-duty trucks.

- Conical design gives increased strength, stability, and fits securely on a Pitman arm.
- Spread is 1-1/2" with a reach of 2-1/2".
- 3/4-16 x 4-3/4" forcing screw provides enough power to remove stubborn Pitman arms.



7503HD
Heavy Duty Tie Rod and Ball Joint Remover

A universal heavy-duty puller that removes a wide range of tie rods and ball joints from a variety of cars, trucks, SUVs and heavy-duty vehicles. The 7503HD has a 10-ton pulling capacity, twice the force applied by the original 7503. Jaw spread and reach are increased to 3 and 4 inches for a wider variety of applications and larger vehicles. A heavier duty forcing screw is used, measuring 3/4" - 10, 6 1/2" long with interchangeable tips including cone, flat and cup for multiple applications. The tool will also remove pitman arms and can be used in many pulling situations that require a 2 jaw puller on other vehicles types and machinery.

6531
Pitman Arm Separator

Separating Pitman arms on cars and light trucks is quick and easy with this wedge and an appropriate sized hammer.

- 11" long and has a 1-1/8" fork spread.

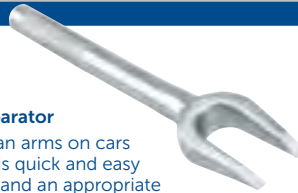

6532
GM Pitman Arm Remover

Removes Pitman arms on pickups and sport utility vehicles. The wedge end is placed between the Pitman arm and steering gear box, and with just a few hammer blows, it separates them. Works on 1988 and newer Chevrolet and GMC 1/2- and 3/4-ton 4WD pickups, Suburban, Tahoe, and Yukon.

- 11-3/4" long with a 1-5/8" fork spread.



6533
Separator Tool

This handy tool is multipurpose. It will remove camber adjustment sleeves on 1980-86 F-150 & F-250 and 1982-88 Bronco II & Ranger Ford pickups that have an adjustable camber. It's also a separating tool for tie rods on medium- and heavy-duty trucks. And it works as a Pitman arm wedge on light trucks.

- 11-5/8" long with a 1-7/16" fork spread.

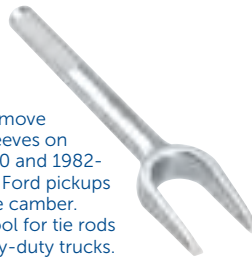

6534
Shock Link and Tie Rod Separator

Here's a tool that will convince even the most stubborn shock links and tie rods to part company. Just insert the tapered wedge between the seized parts, and smack the other end with a hammer.

- 16" long with 11/16" fork spread.

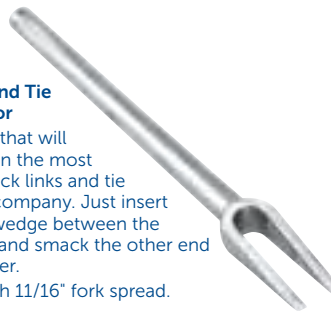

6535
Ball Joint Separator

Ball joint service is easier with this tool. It was designed to remove ball joints from spindle support arms, and can be used on a wide variety of vehicles, from compact cars to light-duty trucks.

- 16" long and has a 15/16" fork spread.



6299
Separator Set (5 piece)

- Features five popular "pickle forks" in a blow-molded case.
- Used to remove shock linkage, tie rods, and ball joints. Also for general service on many cars and light trucks.

Includes:

- 6531 – Size 11" x 1-1/8" Fork Spread.
- 6532 – Size 11-3/4" x 1-5/8" Fork Spread.
- 6533 – Size 11-5/8" x 1-7/16" Fork Spread.
- 6534 – Size 16" x 11/16" Fork Spread.
- 6535 – Size 16" x 15/16" Fork Spread.



4559
Manual / Pneumatic Pickle Fork Set

- Use to separate ball joints, tie rods, and Pitman arms.
- Set contains two handles: knurled handle allows use of a hammer; smooth handle fits in a pneumatic hammer.
- Three sizes of pickle forks included: 1-1/8", 15/16", and 11/16".

Set contains:

4559-1

Fork heads (set of three: 11/16", 15/16", and 1-1/8").

4559-2

Handles (set of two: knurled handle for use with a hammer; smooth handle for use with an air hammer).

SEE PAGE 43 FOR GREASE GUNS

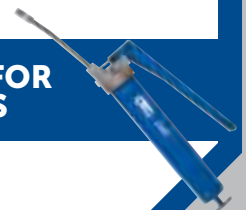



6275 Tie Rod/Pitman Arm Adjusting Set

These tools have a unique design that permits 360° rotation of the adjusting sleeve, even where space is limited.

- Accommodates 1/2" drive ratchet or breaker bar.
- Set consists of the following tools in a blow-molded case:

- 7095** For compact cars with 3/4" diameter adjusting sleeves.
- 7096** For full size cars with 7/8" diameter adjusting sleeves.
- 7097** For light trucks with 1-1/8" diameter adjusting sleeves.
- 6274** For Ford 3/4-ton and 1-ton trucks with 1-13/16" diameter adjusting sleeves.
- 6084** Pitman arm adjusting tool for Ford F-250 thru F-450 trucks with 1-7/16" dia. adjusting sleeves.

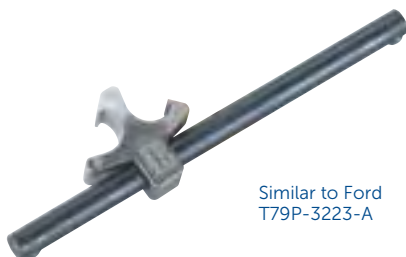

Similar to Ford T79P-3223-A

7023 Tie Rod Adjusting Tool

Here's a tool that will fit most models of compact and standard-size cars and light trucks. It has a four-position feature and 360° rotation that lets you locate the tool to grip the sleeve correctly, even when access is limited.

5068 Truck Tie Rod Socket

Designed to withstand the force of a 3/4" drive impact wrench, this rugged socket makes truck tie-rod end removal quick and simple.

- Works on inner and outer tie rod ends on 12,000 to 16,000 lb. truck axles.
- Socket I.D. 2-3/4"



7484 Standard



7500 Standard



7501 Heavy-Duty

Inner Tie Rod Wrenches (Standard & HD)

Universal wrench will fit on all styles and allow the technician to un-screw the tie rod link for replacement.

7484 Unique lever design will turn hex rack ends or hex shafts from 1" to 1-5/8" (25-41mm).

7500 Unique cam design cover sizes from 1-1/4" to 1-5/8" (33-41mm) hex, 2 flats, round or any style rack ends.

7501 Unique cam design cover sizes from 1-1/2" to 1-7/8" (38-48mm) hex, 2 flats, round or any style rack ends.

Similar to Ford 211-D029(D93L-3395-A)



7595A Inner Tie Rod Removal Set

Remove and install inner tie rods without removing steering gear. The adapters fit into the tie rod socket, and a 1/2" drive ratchet or breaker bar fits the drive end.

- Services both old and new style inner tie rods.
- For use on most Chrysler, Ford, and GM vehicles.
- The socket is 16" long and is "stepped" to accept 1-3/16" tie rods and 1-5/16" tie rods.
- Adapters fit into socket and work on 1-3/16", 1-5/16", and 1-7/16" tie rods.

Important: When removing and installing inner tie rods, hold steering rack shaft to prevent damage to pinion gear.

6065 Tie Rod Socket for Medium-Duty Trucks

Here's a heavy-duty tool for removing tie rod ends on Chrysler, Ford, and GM 1-ton trucks. It also works on many medium-duty trucks, Class 2 through 6.

- Accommodates a 1/2" drive impact wrench.



Similar to 211-185

7771A Ford Power Steering Pump Pulley Installer

Installs power steering pump pulleys on 1992–newer Ford Crown Victoria and Mercury Grand Marquis with 4.6 V8 engine, 1997–newer Ford truck with 4.2 & 4.6 V6, 5.4 V8, and 6.8 V10 engines.

- 8 mm x 1.25" threads fit Ford's C111 pump.

6695 Similar to Ford 205-429

6697 Similar to Ford 205-830

6698 Similar to Ford 205-831

Ford Axle Shaft Seal Installers

Correctly installs the seal onto the axle shaft and into the wheel knuckle, preventing front hub vacuum leaks that would cause the 4WD to not engage.

6695 Ford Axle Shaft Seal Installer. Works on 1998-2004 Ford F-250, F-350, F-450, and F-550 4X4s having the vacuum-operated front axle.

6697 Ford Axle Shaft Seal Installer. Works on 2005–newer Ford F-250, F-350, 4X4s having the vacuum-operated front axle.

6698 Ford Axle Shaft Seal Installer. Works on 2005–newer Ford F-450, F-550, 4X4s having the vacuum-operated front axle.



7220
Power Steering Bleeder Adapter

- Allows for air to be bled out of power steering systems.
- Used in conjunction with the a vacuum hand pump or brake bleeder.
- Fits GM and other makes power steering reservoirs.
- Similar to J-43485.



7209
GM Power Steering Pump Pulley Installer

This tool offers easy, damage-free installation of power steering pump pulleys. It works on 1988–95 GM Quad 4 engines; 1990–94 Chevrolet Lumina APV, Oldsmobile Silhouette, and Pontiac Trans Sport vehicles; 1990–94 3.1L V6 engines; 1994–newer 3100 GM V6; 1999–newer 3400 GM V6. Threads are 3/8–16" to fit pulley shaft threads.



7362
GM Power Steering Pump Pulley Service Kit

Remove and install the power steering pump pulley easily and without damaging the pump shaft or pulley.

- Includes remover and installer.



4681
Power Steering Pump/Alternator Remover/Installer Tool

- Reversible 2-in-1 tool removes and installs press-fit alternator and power steering pump pulleys.
- Also removes and installs other press-fit pulleys with a hub diameter of 1-1/8" (28 mm), 1-1/4" (32 mm), 1-5/16" (34 mm), or 1-3/8" (35 mm).



Similar to Ford 211-016(T69L-10300-B)

7185
Power Steering Pump/Alternator Pulley Remover

This puller removes pulleys on most Chrysler, Ford, GM, and VW vehicles fitted with Saginaw, Thompson, or Ford's C2 and C111 power steering pumps; GM belt-driven vacuum pumps on cars; and press-on water pump pulleys on GM 4- and 6-cylinder engines. It works on pulleys with hub diameters of 1-1/8", 1-1/4", 1-5/16", and 1-3/8".

- Designed to ensure damage-free removal.



4529
Power Steering /Alternator Pulley Puller/Installer Set

- Properly replaces pressed-on power steering and alternator pulleys on Ford, Chrysler, and late GM engines.
- Housed in a blow-molded plastic storage case.



7830A
Power Steering Pump Pulley Kit

This kit has nearly everything you need to remove and install power steering pump pulleys in Chrysler, Ford, and GM vehicles with Saginaw, Thompson, and Ford C111 and C2 power steering pumps. Fits 1-1/8", 1-1/4", 1-5/16" and 1-3/8" pulley hub diameters, including 1988–newer GM cars equipped with Quad 4 engines; 1991–94 GM 3.1L V6; 1991–newer 3800 V6 engines; 1994–newer GM 3100 V6; 1999–newer GM 3400 V6, and 1992–newer Ford Crown Victoria and Mercury Grand Marquis with 4.6 V8 engine, 1997–newer Ford truck with 4.2 & 4.6 V6, 5.4 V8, and 6.8 V10 engines.

- Also includes No. 7931 spacer for work on Chrysler Cirrus, Dodge Stratus, and Plymouth Breeze.



Similar to Ford 211-009(T65P-3A733-C)

7005
Power Steering Pump Pulley Installer

This is an ideal companion to our No. 7185 pulley remover. It's a real time saver for installing power steering pump pulleys and GM press-on water pump pulleys.

- Designed to ensure damage-free installation.
- Internal roller bearing allows for easy turning.
- Threads are 3/8"-16 to match pulley shafts.



4530
Power Steering Pump Pulley Service Set

- A complete set of tools required to remove and install power steering pump pulleys of most domestic vehicles.
- Fits pulley hubs with diameters of 1-1/8", 1-1/4", 1-5/16" and 1-3/8".
- Includes the necessary adapters for servicing: GM 3.1L, 3100, 3400, and 3800 V6 engines, GM 2.3L Quad 4 four-cylinder engines, and Ford 4.6L and 5.4L V8, 6.8 V10 engines.



Similar to Kent Moore J-21854-A

7889
Steering Pivot Pin Remover

Tilt steering columns are much easier to service when your tool box has one of these pivot pin removers in it. Works on GM, Chrysler, and Ford vehicles with Saginaw tilt steering columns.

7122R
Ford Lock Pin Remover

Removes tie rod inner socket retaining pin on Ford vehicles with rack and pinion power steering. Replacement tips available separately.

37907 Tip for 7122R

Similar to Ford 211-D002

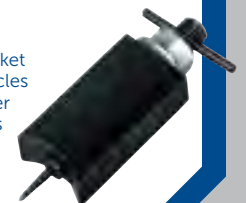

STEERING SERVICE AUTOMOTIVE SPECIALTY TOOLS



7984 Master Steering Wheel Service Set

- This master set is used for steering column service on most cars and light trucks, domestic and imports.
- This set includes components for steering wheel, lock plate removal, and pivot pin removal.
- Special 5/16-18 x 4" shoulder bolts allow removal of GM steering wheels without damaging the SIR module. Also use the 5/16-18 x 4" shoulder bolt for earlier models without SIR module.
- This set includes a lock plate compressor with M14 x 1.5 and 9/16-18 forcing screws for steering column shafts on GM S.I.R., as well as older GM, AMC, and Chrysler vehicles with tilt, telescoping, and conventional steering columns. Use on steering columns with or without air bags.
- Includes a screw to contain the telescopic steering column on older GM vehicles.
- The pivot pin remover covers tilt steering pivot pins on 1969 and newer GM, Ford, and Chrysler vehicles with Saginaw steering columns.
- Two hook-shaped puller legs and special forcing screw adapter remove the steering wheels without tapped pulling holes.

This set includes three each of the following hardened bolts:

- Washer Head Bolts (Grade 8) 1/4-28 UNF x 3"
- Hex Head Flange Bolts 3/8-16 UNC x 3.5"
- Hex Head Flange Bolts 5/16-24 UNF x 3.5"
- Hex Head Flange Shoulder Bolts 5/16-18 UNC x 4"
- Hex Head Flange Bolts M8 x 1.25 x 90mm

7929A Steering Wheel Puller Leg Set

- Particularly useful during steering wheel removal when there are no tapped holes in the assembly.
- The 7929A is designed for use with either the No. 7245 or No. 7403 OTC steering wheel puller.
- These legs get behind the steering wheel assembly to provide an even, straight pull. The collar is designed for use on Ford and Chrysler vehicles.
- Works on:
 - 1988-1993 Pontiac LeMans
 - 1997-newer GM cars, SUVs, and light trucks
 - 1997-newer Ford SUVs and light trucks
 - 1999-newer Jeep Grand Cherokee
 - 2003-newer Jeep Liberty
 - 2004-newer Dodge Sprinter van



4-1/2" reach



7790 Flange-Type Puller Set (Grade 5)

- Versatile puller capable of removing a wide variety of components having tapped pulling holes, including harmonic balancers, gears, crankshaft pulleys, etc.
 - Capable of handling 2- or 3-way bolt pulling applications.
 - Works on many cars, pickups, SUVs, and small engines.
 - Carries the OTC Lifetime Warranty® against defects in workmanship and material.
- Contents of set:
- Puller flange: adapts to bolt circle dia. of 1-1/2" to 4-5/8".
 - Forcing screw: 5-5/8" lg., 5/8-18 thread.
 - Shaft protector: 1-3/16" dia. x 3/4" thick.
 - Three each of the following flat washers: 1/4"; 5/16"; 3/8".
 - Three each of the following bolt sizes:

- 1/4"-28 x 3" lg.	- 3/8"-16 x 2" lg.
- 5/16"-24 x 3" lg.	- 3/8"-16 x 3" lg.
- 5/16"-18 x 3-1/2" lg.	- 3/8"-16 x 4-1/2" lg.
- 5/16"-18 x 6" lg.	- M8 x 1.25 x 45 mm lg.
- 3/8"-24 x 1-1/2" lg.	- M8 x 1.25 x 65 mm lg.
- M8 x 1.25 x 90 mm lg.	
- M10 x 1.5 x 35 mm lg.	



7927A Steering Wheel Remover/Lock Plate Compressor Set

With this set, it's easy to remove the steering wheels of most domestic and imported vehicles, with or without tilt steering columns. Also accesses the turn signal switch and SIR modules on current GM vehicles.

- Includes No. 7815 steering wheel lock plate remover, No. 7889 steering pivot pin remover for Saginaw steering columns, No. 7245 steering wheel puller, plus four sets of cap screws (2 of each size: M8-1.25 x 90 mm, 3/8"-16 x 3-1/2", 5/16"-24 x 3-1/2", and 5/16"-18 x 4").
- Contained in convenient plastic blow-molded case.



6930 Flange-Type Puller Combination

Heavy-duty flange puller features a live center forcing screw. Includes two live center forcing screw tips and two sets of commonly used automotive bolts. Puller will work on bolt circles from 1-1/2" to 4-1/4". Three cap screws, 3/8-24 x 3" long, and three cap screws, 3/8-16 x 3" long.



7815 Steering Wheel Lock Plate Remover

This is an essential tool for compressing steering wheel lock plates on AMC, Chrysler, and GM vehicles, with or without tilt steering columns. It's also necessary for accessing the turn signal switch and SIR modules on GM vehicles.

- Also works on metric columns.

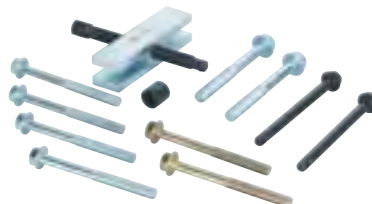

7245 Steering Wheel Puller

This puller removes steering wheels on most domestic and imported vehicles, with or without telescoping steering columns. Five sets of cap screws are included for various thread requirements. The forcing screw features a swivel end to protect steering shaft. Cap screws included (pairs): 3/8-16 x 3-1/2"; 5/16-18 x 3-1/2"; 5/16-24 x 3-1/2"; M8-1.25 x 90 mm; 5/16-18 x 4 (SIR). Bar measures 4" x 1" x 1".



7403 Steering Wheel, Pulley, and Flywheel Puller

Here's a puller that works in a variety of applications. It pulls steering wheels on most late model cars. It also works as a regular 2/3-way puller to remove pulleys and small engine flywheels. Cap screws included (pairs): 3/8-16 x 3-1/2 in.; 5/16-18 x 3-1/2 in.; 5/16-24 x 3-1/2 in.; M8-1.25 x 90 mm; and 5/16-18 x 4 in. (SIR).

- Works on domestic cars with or without collapsible steering columns.

STRUT TAMER II EXTREME

THE 6637 STRUT TAMER II EXTREME SETS A NEW STANDARD IN STRENGTH AND SAFETY FOR STRUT SPRING COMPRESSORS.

- New forged locking jaws includes larger pads and offset to clamp onto and compress springs even tighter than before.
- New extra thick 5/8" compression arms for superior strength, stability and safety.
- New locking trunions for optimal stability during spring compression.
- New Lock rings to hold arms in position - standard. This eliminates arms from spreading or sliding when compressing offset or unique strut configurations. No tools needed to adjust.
- New Spring capacity of 2-1/2" - 10" diameter, 1-1/4" - 24" vertical stroke.
- Extreme duty design to handle the heavier springs found on mid- and some full-size truck strut assemblies.



Locking trunions increase stability during spring compression

Extra-thick 5/8" compression arms for strength, stability and safety

Stand with wheels for portability (OTC6637-ST only)

During compression, the wheels lift off the floor, and four no-slip rubber pads keep the stand firmly in place

2:1 reduction gearbox - standard. Allows for a 2:1 torque compression increase when compressing struts.

New forged locking jaws include larger pads to clamp and compress springs tighter

Spring capacity of 2-1/2" - 10" diameter, 1-1/4" - 24" vertical stroke

New arm-locking rings hold strong without needing tools to adjust

✓ MEETS THE NEW ASME PASE SAFETY STANDARDS FOR SPRING COMPRESSION
✓ CAPABLE OF SAFELY COMPRESSING THE LARGEST STRUT SPRINGS



Strut assembly not included



6637
StrutTamer II Extreme
Height 29" (736 mm)
Width 21" (533 mm)
Depth 20" (508 mm)



6582
StrutTamer Stand
Height 44" (1118 mm)
Width 22-1/2" (572 mm)
Depth 32" (813 mm)

Note: 6637-ST, 6637 can be shipped UPS.



6591-1
Upper Arm Clamps

6637-ST
StrutTamer II Extreme
with stand Height 54" (1372 mm)
(36" without handle)
Width 22-1/2" (572 mm)
Depth 32" (813 mm)



6587
2:1 Reduction Gearbox
• Allows a 2:1 torque compression increase when compressing struts. Fits on StrutTamer™ Extreme or StrutTamer™ HD.

6494
Clamshell Strut Spring Compressor
Servicing MacPherson struts is convenient and affordable with this compressor. It fits a wide range of struts and requires no special adapter shoes.

- Locking pins hold the compressor jaws in place.
- Tool compresses springs of 4 in. to 9 in. O.D., with diameters of 7/16" to 11/16".
- Built to use with an impact wrench.

Note: Not to be used on conventional coil springs.



6583
StrutTamer™ Compressor Bridge Accessory

- Used to compress strut springs if technician prefers to press on the top plate of the strut rather than attaching the locking jaws to the top coils of the spring.
- Attaches to the locking jaws and is manually adjusted to bridge the strut top plate to be compressed. Lower part of spring is still held in the two lower locking jaws.



**6559
Ball Joint Master Service Kit. The ultimate ball joint service kit!**

- The 6559 Ball Joint Master Service Kit offers complete coverage of Car and Truck/Van/SUV applications. With 70+ adapters, c-frame and application guide means there is nothing else to add for servicing ball joints.
- The majority of vehicles have press-in ball joints, so stop searching for make-shift solutions for servicing these vehicles – everything required is laid out in this one complete kit.
- With a kit of this magnitude, finding the correct adapters and using them correctly is key to minimizing service time. That is exactly what the included ball joint application guide is designed to do – contains application charts and diagrams with step-by-step instructions.



**6529
Car Ball Joint Master Service Kit.**

- This 50+ adapter kit is the most complete Car ball joint service kit available, and the first of it's kind on the market.
- With 70% of OEM's having cars with press-in ball joints, this kit is designed to service those applications.
- This kit is a subset of the 6559 and includes 50+ adapters, C-Frame, Ball Joint Application Guide, and Location Card all provided in 2 cases.



**6539
Truck Ball Joint Master Service Kit.**

- This 55+ adapter kit is the most complete Truck/Van/SUV ball joint service kit available.
- With the majority of Truck/Van/SUV applications having press-in ball joints and universal joints, this kit is designed to service those applications. (note; covers same applications as the 8031 Chrysler/Jeep Truck/Van/Suv Ball Joint Kit without requiring larger C-Frame).
- This kit is a subset of the 6559 and includes 55+ adapters, C-Frame, Ball Joint Application Guide, and Location Card all provided in 2 cases.



**6530
Ball Joint Intermediate Service Kit**

- This 20+ adapter kit covers many Truck/Van/SUV applications and some car applications.
- With the majority of Cars and Truck/Van/SUV applications having press-in ball joints and universal joints, this kit is designed to service many of those applications.
- This kit is a combination of 7249, 7918, and 7996 kits, and includes 20+ adapters, C-Frame, and Application Diagrams all provided in a case.



**8031
Chrysler/Jeep Truck/Van/SUV Service Kit**

- This 18 adapter kit covers Chrysler/Jeep Truck/Van/SUV 2WD and 4WD applications.
- Includes Large C-Frame for use with the OEM size ball joint adapters.
- Includes 18 adapters, Large C-Frame, application chart and instructions all provided in a case.



**7249
Ball Joint Starter Service Kit**

- This starter kit is the backbone to ball joint, U-joint, anchor pins, and many other general pressing operations. Kit includes 5 adapters and C-Frame provided in a case.

**7248
U-Joint Removing/Installing Tool**

This helpful tool uses a forcing-screw press to safely remove and replace automotive universal joints with needle bearings, including GM plastic pin CV U-joints.

Similar to Ford 205-086 (T74P-4635-C)



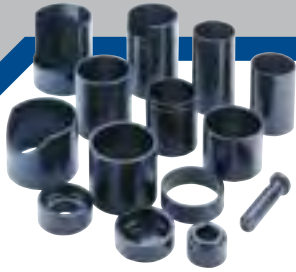

7918
Ball Joint Update Adapter Set

- This adapter set will update a 7249 Ball Joint Starter Service Kit to a 6530 Ball Joint Intermediate Service Kit, less the 7996 Honda Ball Joint Lower Ball Joint Adapter Set. Greatly expands the application coverage.



6529-1
BMW Car Ball Joint Adapter Set

- 11 adapters included to remove & install ball joints.
- Works on upper and lower ball joints on: 1992 – 1999 318 series, 1998 – 1999 323 series, 1996 – 1999 328 series, 1996 – 1999 M3.
- Vehicle application chart and diagrams included. Does not include the 7248 C-Frame press.



6529-2
Chrysler/Mitsubishi Car Ball Joint Adapter Set

- 20 adapters included to remove and install ball joints.
- Works on upper and lower ball joints on Chrysler, Dodge, Plymouth, and Mitsubishi cars with press in ball joints
- Vehicle application chart and diagrams included. Does not include the 7248 C-Frame press.

8033
Chrysler Ball Joint Socket

- Removes and installs the screw-in type ball joints used on mid-size, rear-wheel drive Chrysler cars.
- Similar to Miller Tools No. C-3560.
- Socket is 2" long with a 3/4" drive; fits 1-59/64" ball joints.



6529-3
Ford/Mazda Car Ball Joint Adapter Set

- 25 adapters included to remove & install ball joints
- Works on upper and lower ball joints on Ford, Lincoln, Mercury, and Mazda cars with press in ball joints
- Vehicle application chart and diagrams included. Does not include the 7248 C-Frame press.



8032A
Ford/Mercury Car Ball Joint Adapter Set

- Allows easy removal and installation of the lower ball joint on 1996–2009 Ford Taurus and Mercury Sable vehicles.
- Lower ball joint can now be replaced without having to replace the entire spindle assembly saving up to an hour of labor.
- Adapters are used with OTC No. 7248 C-Frame.



6648
Ford Transit Connect Van Ball Joint Adapter Set

- This 4-adapter set is used in conjunction with the 7248 C-frame to remove and install ball joints on Ford Transit Connect Vans. Set contains adapter part numbers 580517, 580526, 581646, and 581647 for use on 2010-2013 Ford Transit Connect Vans.



6529-4
GM Car Ball Joint Adapter Set

- 18 adapters included to remove & install ball joints.
- Works on upper and lower ball joints on Chevrolet, Buick, Pontiac, Oldsmobile, and Cadillac cars with press in ball joints
- Vehicle application chart and diagrams included. Does not include the 7248 C-Frame press.

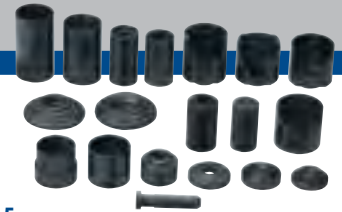

6529-5
Honda/Acura Car Ball Joint Adapter Set

- 19 adapters for removing & install ball joints
- Works on upper and lower ball joints on Honda and Acura cars with press in ball joints
- Vehicle application chart and diagrams included. Does not include the 7248 C-Frame press.

7996
Honda Car Ball Joint and Adapter Set

- Use with ball joint service set Nos. 6530, 7248, and 7249 to remove and install lower ball joints on Honda 1986–97 Accord, 1988–00 Civic, 1993–99 del Sol, 1988–91 CRX, and 1983–99 Prelude.



6734
Honda/Acura Car Ball Joint Adapter Set

- Use this three-piece tool kit, along with OTC C-frame No. 7248, to remove and install lower ball joints on the following Honda and Acura vehicles:
- Honda Accord Sedan '03-'08
 - Honda Accord Coupe '03-'08
 - Acura TSX '04-'08



6653
Acura/Honda Ball Joint Adapter Set

- This 4-adapter set is used in conjunction with the 7248 C-frame to remove and install ball joints on select Acura and Honda vehicles. Set contains adapter part numbers 580518, 554419, 554414 and 313967 for use on:
- 2009–2014 Acura TL and TSX
 - 2008–2012 Honda Accord
 - 2010–2011 Honda Accord Crosstour
 - 2012–2014 Honda Crosstour



6529-6
Import Car Ball Joint Adapter Set

- 15 adapters for removing & install ball joints.
- Works on upper and lower ball joints on Toyota, Hyundai, Kia, Infinity, Saab, and Nissan cars with press in ball joints
- Vehicle application chart and diagrams included. Does not include the 7248 C-Frame press.

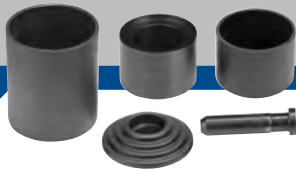

6649 Chevy/GMC Ball Joint Adapter Set

This unique 3-adapter set is used in conjunction with the 7248 C-frame to remove and install ball joints on Chevy and GMC vehicles. Set contains adapter p/n's 580524, 305227 and 580523 for use on 2011-2017 2500HD and 3500HD:

- Chevrolet Suburban, Avalanche and Silverado
- GMC Sierra and Yukon XL

6652 Subaru Ball Joint Adapter Set

This 3-adapter set is used in conjunction with the 7248 C-frame to remove and install ball joints on select Subaru vehicles. Set contains adapter part numbers 581996, 581995 and 581994 for use on:

- 2005-2006 Baja
- 2016-2017 Crosstrek
- 1998-Present Forester
- 1993-Present Impreza
- 1990-Present Legacy
- 2000-Present Outback
- 2015-Present WRX
- 2014-2015 XV
- 2013-2015 XV Crosstrek
- 2006-2007 B9 Tribeca
- 2008-2014 Tribeca



6647 Lexus/Toyota Ball Joint Adapter Set

This 4-adapter set is used in conjunction with the 7248 C-frame to remove and install ball joints on select Lexus and Toyota vehicles. Set contains adapter part numbers 222307, 305227, 204508A and 580569 for use on:

- Lexus - 2003-2009 GX470
- Toyota - 2003-2017 4Runner, 2007-2014 FJ Cruiser



6646 Lexus/Hyundai/Kia Ball Joint Adapter Set

This 4-adapter set is used in conjunction with the 7248 C-frame to remove and install ball joints on Lexus, Hyundai and Kia vehicles.

Set contains adapter part numbers 554413, 580570, 581426 and 38355A for use on:

Lexus	Hyundai
2006 GS300	2006-2011 Azera
2007-2011 GS350	2006-2010 Sonata
2006-2015 IS250	Kia
2016-2017 IS300	2007-2009 Amanti
2011-2017 IS350	



6529-10 Car Ball Joint Master Set Upgrade for 6539

- 14 additional adapters required to complete a 6529 Car Ball Joint Master Set when added to the 6539 Truck Ball Joint Adapter Set.



6651 Mazda CX7 & CX9 Ball Joint Adapter Set

This 4-adapter set is used in conjunction with the 7248 C-frame to remove and install ball joints on Mazda CX7 and CX9 vehicles. Set contains adapter part numbers 580585, 554413, 531739 and 554414 for use on 2007-2012 CX7 and 2007-2014 CX9.



6539-1 Import Truck Ball Joint Adapter Set

- 35 adapters included to remove & install ball joints.
- Works on upper and lower ball joints on Toyota, Honda, Acura, Hyundai, KIA, Infinity, Isuzu, and Nissan Trucks, Vans, and SUV's with press in ball joints.
- Vehicle application chart and diagrams included. Does not include the 7248 C-Frame press.



6539-2 Chrysler/Mitsubishi Truck Ball Joint Adapter Set

- 35 adapters included to remove and install ball joints.
- Works on upper and lower ball joints on Chrysler, Dodge, Jeep, Plymouth, and Mitsubishi Trucks, Vans, and SUV's with press in ball joints.
- Vehicle application chart and diagrams included. Does not include the 7248 C-Frame press.

8034 Chrysler Ball Joint Socket

- Removes and installs the screw-in type ball joints used on Chrysler / Dodge light trucks and vans.
- Similar to Miller Tools No. C-3561.
- Socket is 2" long with a 3/4" drive; fits 2-9/64" ball joints.

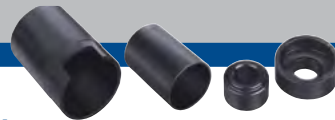

7894 Dodge/Jeep Truck, SUV Ball Joint Adapter Set

Use with ball joint service set Nos. 6530, 7248, and 7249 to remove or install aftermarket and original equipment upper and lower ball joints, and the offset ball joints used to change caster/camber. Works on '84-'89 "downsized" Jeep Wagoneer, Cherokee and Comanche; '87-'08 Wrangler; '93-'04 Grand Cherokee; '94-'99 Dodge Ram 4WD 1/2-ton pickup.



6735 Sprinter Van Ball Joint Kit

- Eight piece kit contains the tools needed to service lower ball joints on '04-'09 Dodge and '04-'12 Freightliner® Sprinter vans: tie rod remover / separator; wheel alignment studs; ball joint remover; driver, receiver, and installing rings.
- Use this kit with OTC No. 6736 C-frame.

6736 Large C-Frame

- Required for use with No. 6735 Sprinter Van Ball Joint Kit.
- When used with OTC No. 6730 Update Kit, you can expand the applications of OTC Nos. 7249, 7918, 6529, 6539 and 6530 Ball Joint Kits.



6730 C-Frame Update Kit

Kit contains two adapters which, when coupled with the large C-frame 6736 included in OTC No. 8031 SUV Ball Joint Kit, make it possible to use any adapter designed for use with the smaller OTC No. 7248 C-frame.



6539-3 Ford/Mazda Truck Ball Joint Adapter Set

- 32 adapters included to remove and install ball joints.
- Works on upper and lower ball joints on Ford, Lincoln, Mercury, and Mazda Trucks, Vans, and SUV's with press in ball joints.
- Vehicle application chart and diagrams included. Does not include the 7248 C-Frame press.



**6731
Ford Truck Ball Joint Adapter Update Kit**
Three-piece kit contains specialty ball joint adapters for use with the industry standard OTC No. 7248 C-frame. Designed to work with the following Ford vehicles: F-150 '97-'03, F-250 '97-'99, Expedition '97-'02, Explorer '95-'05, Ranger '98-'08.



**7825
Ford Van Ball Joint Adapter**
This tool enables you to quickly remove the lower ball joint on '92 to '08, 3/4- and 1-ton vans (E-250 and E-350) when used with ball joint service set Nos. 6530, 7248, and 7249.



**7919
Ford 2WD Van Ball Joint Adapter Set**
This set is designed to remove/install press-fit upper and lower ball joints. Fits most Ford '92 to '04 2WD 3/4- and 1-ton vans.



**6733
Honda/Toyota Truck/Van/SUV Ball Joint Adapter Set**
Two-piece kit contains specialty ball joint adapters for use with the industry standard OTC No. 7248 C-frame. Designed to work with the following Honda and Toyota vehicles:

- Honda CR-V '97-'06, Honda Odyssey '95-'06
- Toyota 4 Runner '96-'02 Toyota Sequoia '01-'08
- Toyota Tacoma '95-'04

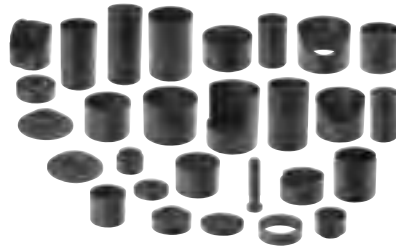

**6539-4
GM Truck Ball Joint Adapter Set**

- 28 adapters included to remove & install ball joints.
- Works on upper and lower ball joints on Buick, Cadillac, Oldsmobile, Pontiac, Chevrolet, GMC, and Hummer Trucks, Vans, and SUV's with press in ball joints.
- Vehicle application chart and diagrams included. Does not include the 7248 C-Frame press.



**6732
GM Truck/SUV Ball Joint Adapter Set**
Four-piece kit designed to be used with the industry standard OTC No. 7248 C-frame. Contains specialty ball joint adapters to fit the following GM vehicles:
TrailBlazer & Envoy '02-'08, 1500 Silverado '99-'06, Suburban & Tahoe '95-'06, Avalanche '02-'08, Escalade '99-'07 Express & Savana '03-'08, Hummer H2 '03-'07.



**7920
GM 4WD Truck/SUV GM Ball Joint Adapter Set**
Use with ball joint service set Nos. 6530, 7248, and 7249 to service GM's 1996 to 1999 4WD 1/2- and 3/4-ton pickups, and Suburban, Yukon, and Tahoe SUVs. Easily remove or install either aftermarket or original equipment press-fit lower ball joints.



**6539-10
Truck Ball Joint Master Set Upgrade for 6529**
18 additional adapters required to complete a 6539 Truck Ball Joint Master Set when added to the 6529 Car Ball Joint Adapter Set.



**7704
Domestic 4WD Truck Ball Joint Adapter Set**
This kit is used with ball joint service set Nos. 6530, 7248, and 7249 to remove and install upper and lower ball joints on '67 to '92 1/2- and 3/4-ton 4WD vehicles fitted with Dana 44 front axles (found on Ford, Dodge, GM, International, and Jeep vehicles).



**7080
Domestic 4WD Truck Ball Joint Spanner Wrench**
Designed for removal and installation of ball joint adjusting sleeves on 1/2-, 3/4-, and 1-ton Dana 44 open yoke front axles found on Chrysler, Ford, GM, International, and Jeep 4WD vehicles.

- Permits easy torquing with 1" socket for correct upper ball-joint preload.

**6529MAN-17
Ball Joint Application Guide**
Reference all ball joint adapter applications. Can be used with all ball joint kits and adapter sets.



- New application guide to cover Car and Truck/ Van/SUV makes and models thru 2017.
- References Bolt In/Press Fit, Removal/ Install adapter p/n's, and replace control arm applications.
- Includes Remove/Install diagrams with adapter p/n's to eliminate guess work.
- Quick Reference Chart to quickly determine if tools are required and which kit contains them.



Sample of Diagram and Application Chart

SUSPENSION SERVICE AUTOMOTIVE SPECIALTY TOOLS



7068 Upper Control Arm Bushing Service Set

Now you can easily replace press-in type upper control arm bushings on most rear wheel drive Chrysler, Ford, and GM vehicles. Mechanical screw power does the work. Set includes C-frame, screw assembly, and all adapters needed for quick removal or installation of bushings without removing or damaging the control arm.

Similar to
Kent Moore J-42393



7822A GM Torsion Bar Unloading Tool

This rugged tool is built for 2010 and older GM K-3500 series trucks with heavy-duty chassis and a larger torsion bar. It features a larger C-frame opening to accommodate beefier torsion bars. The tool holds the torsion bar while you make adjustments. It also works on 1988 to 2012 GMC and Chevrolet 1/2-, 3/4-, and 1-ton pickups; the S-10 Blazer and S-15 Jimmy, 4WD pickups with 4.3L V-6 engines; and 1991 to 2001 Oldsmobile Bravada.



7832 GM Torsion Bar Unloader

- Larger design to also cover the newer GM truck applications.
- Application; 2011 & newer HD C/K trucks, 2010 and older GM K3500 series trucks with heavy-duty chassis and a larger torsion bar. 1988 to 2003 GMC and Chevrolet 1/2-, 3/4-, and 1-ton pickups; the S-10 Blazer and S-15 Jimmy, 4WD pickups with 4.3L V-6 engines; and 1991 to 2001 Oldsmobile Bravada.

- 7832-1** GM Torsion bar unloader
- 7832-2** Forcing screw

Similar to
Ford 204-185
(T95T-5310-AR)



7816 Ford Torsion Bar Adjustment Tool

Before servicing a torsion bar on 1995–2001 Ford Explorer and 1998–2001 Mercury Mountaineer vehicles, you must first contain the bar to avoid possible damage. This tool securely accomplishes that task, allowing you to make adjustments.

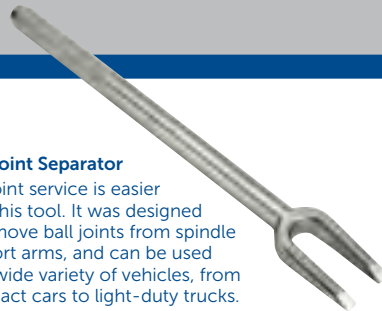

6535 Ball Joint Separator

Ball joint service is easier with this tool. It was designed to remove ball joints from spindle support arms, and can be used on a wide variety of vehicles, from compact cars to light-duty trucks.

- 16" long and has a 15/16" fork spread.



6297 Ball Joint Separator

This tool is used to separate the ball joint from the spindle support arm. It works on many domestic and import front wheel drive vehicles, and is adjustable up to 2" for different size ball joints.

7534



7537

Upper Arm Alignment Wrenches

These specialized 1/2" drive wrenches provide easy access to the upper control arm bolts for front wheel alignment jobs.

7534 22 mm hex wrench for use on 1990–2005 2WD Chevrolet Astro and GMC Safari, and 1991–2005 AWD Chevrolet Astro and GMC Safari vans.

7537 18 mm hex wrench for use on U.S.-built 1985 to '90 GM Astro vans.



7917 Live Center Forcing Screw Plug

This plug replaces the existing forcing screw on the No. 7248 C-frame to allow its use on heavy-duty ball joints. The shorter length gives the C-frame a wider opening to accommodate the larger ball joints on 3/4- and 1-ton trucks.

6007 Lower Control Arm Prying Tool

Installing a ball joint on a lower control arm typically requires the effort of two people. However, with this tool and our No. 7420 or 7421 pry bar – or any 7/8" diameter pry bar – it's a one-person job.



7826 Ford Truck Torsion Bar Tool

This tool firmly holds the torsion bar on Ford light-duty trucks while you adjust or service the front suspension. Without it, a torsion bar could unwind and possibly cause damage. The tool fits 1997–2003 Ford F-150 4WD pickups, 1995–2001 Ford Explorer 4WD, 1998–2001 Mercury Mountaineer, and 1998–2001 Ford Ranger.



Similar to Kent Moore J-38658

7840 GM Caster/Camber Adjusting Tool

This tool is designed to make caster/camber adjustments quick and easy. Simply place it into the holes in the cross-member and lower control arm, then turn the tool's turnbuckle nut to hold the correct adjustment. This allows you to tighten the adjusting bolts. For use on 1993 to 2000 Chevrolet Camaro and Pontiac Firebird. Also works on 1986–92 Buick Riviera, Cadillac Seville, Oldsmobile Toronado, and 1986–91 Buick Regal.



7829

This wrench is specially bent to fit on the caster/camber adjusting cam on 1995 to 2001 Ford Explorer 4WD SUVs, and 1997 2WD and 4WD F-150 pickups. You can use it on the nut to loosen the adjusting cam, and on the bolt to set the caster/camber.

- Has a 21 mm, 12-point design.
- Accommodates a 1/2" drive ratchet or breaker bar.



Similar to Ford
204-D019(D93T-
3000-A)

7588A Ford 4WD Caster/Camber Sleeve Puller

Rusted or seized bushings are no match for this puller. It easily pulls most aftermarket and OEM bushings on Ford 4WD vehicles. It's the only tool that works on any angle OEM bushing, removing it quickly and without damage. For 1980 to '96 Ford Broncos, full-size E- and F-series vans and pickups; 1983 to '89 Ranger and Bronco II. The puller comes with adapters to pull most aftermarket bushings having removable retaining rings.

221476 Arnwood-style bushing adapter.



6939
Broken Bolt Extractor Tool

- Remove frozen, broken or cut off bolts within steering or suspension bushings.
- Can also be used to remove and install wheel studs and other general pressing needs.



6939-1
Broken Bolt Extractor Adapter Set

Available for use with the 7248 C-Frame.



5057
Broken Bolt/Clevis Pin Extractor Tool

Used for smaller application.



7544
Strut Rod Nut Socket (24 mm)

This specially designed socket is needed to loosen and tighten the top strut nut when servicing the strut spring or strut cartridge. The socket is used with a 1/2" ratchet or breaker bar to turn the strut nut while holding the strut rod with the appropriate wrench. The socket fits 24 mm strut rod nuts found on many domestic FWD vehicles including 1988–96 Pontiac Grand Prix, 1988–98 Oldsmobile Cutlass Supreme, 1988–99 Chevrolet Lumina sedan, 1995–99 Chevrolet Monte Carlo, and 1988–96 Buick Regal.

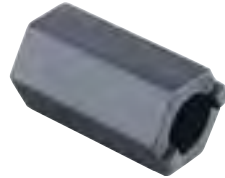

7707
VW and Audi Strut Nut Socket

This 1-3/4" long socket is built for VW and Audi FWD cars in which the top shock-retaining nut is recessed inside the strut tower. The tool's center bore allows you to hold the strut shaft from turning, using a 7/8" (22 mm) hex key and appropriately sized wrench.



7491C
GM Upper Control Arm Knock-Out Tool

Here's the tool you need to remove the inserts on the upper control arm alignment brackets of light-duty GM trucks. It features an indexed forcing bolt that pulls straight and evenly, and works with off-center knock-outs. The tool fits 1989–2001 Chevrolet and GMC 1/2-, 3/4-, and 1-ton trucks, two- or four-wheel drive. Also works on 1990–2001 all-wheel drive Chevrolet Astro vans and GMC Safari vans. 1997–2002 1/2-, 3/4-, and 1-ton full size vans.



6578
Pinch Mount Expander Kit

- For servicing struts, ball joints, or steering knuckles with pinch bolt mounts.
- Remove most stubborn struts and ball joints with ease.
- This separator mounts in the pinch bolt holes and drives the anvil into the pinch slot, expanding the mount for easy component removal.
- Use on aluminum or cast iron pinch mounts; includes 2 dowel sizes.



4533
GM W-Body Strut Tool Kit

- Includes one T50 TORX® bit, a universal drive handle, and a double-ended socket.
- Use one end of the socket to remove/install the jounce bumper; the other end to remove/install the strut cap nut.

Works on GM W-body vehicles:

- 1988–96 Pontiac Grand Prix
- 1988–98 Olds Cutlass Supreme & Chevrolet Lumina Sedan
- 1995–99 Chevrolet Monte Carlo
- 1988–96 Buick Regal



7045B
Front Coil Spring Compressor

This compressor fits most late-model rear wheel drive domestic vehicles in which the coil springs are between the upper and lower control arms. The tool features four case-hardened, self-aligning plates to ensure correct load distribution under tension. Includes two 3-3/8" ID plates and two 4" ID plates. Will not work on Mercedes-Benz vehicles.



7294
MacPherson Strut Spring Hook Compressor

These devices quickly and easily compress most sizes of MacPherson strut springs. Setup is fast and simple. Compression is achieved by alternating from one assembly to another. Each device has a heat-treated alloy thrust screw (5/8"–11 x 12") with forged hooks.

HUB GRAPPLER™



CUT SERVICE TIME DRAMATICALLY

Complete solution for servicing wheel hubs and bearings on the vehicle without removing the steering components or knuckle, eliminating unnecessary alignments or the use of a shop press.

6575 Hub Grappler™ Kit

- Jaws designed and sized to properly fit hub applications and is quickly located on the puller bar without the use of fasteners.
- 3/4" custom drive screw coupled with the special equalizer washer provides smooth operation while proprietary heat treating extends its life 5-10 longer than similar designs.
- Six adapters increase application coverage. Includes tie rod/ball joint tool and two Ford axle installers.
- Included Application Guide is the most comprehensive on the market.



6575H Hydraulic Hub Grappler™ Kit

- An economical way to increase the performance and speed of wheel bearing and hub service.
- Kit includes a through hole 9-ton ram, OTC 2510A air/hydraulic pump, 6 ft. hose with couplers, drive screw and nut.
- Jaws designed and sized to properly fit hub applications and is quickly located on the puller bar without the use of fasteners.
- 3/4" custom drive screw coupled with the special equalizer washer provides smooth operation while proprietary heat treating extends its life 5-10 longer than similar designs.
- Six adapters increase application coverage. Includes tie rod/ball joint tool and two Ford axle installers.
- Included Application Guide is the most comprehensive on the market.

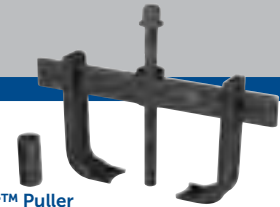

6575-1 Hub Grappler™ Puller

- The new Hub Grappler Puller is specifically designed to apply maximum force with minimal effort from an impact gun to also minimize service time.
- The new jaws are designed and sized to properly fit hub applications and can be quickly located on the puller bar without the use of fasteners.
- The new 3/4" custom drive screw coupled with the special equalizer washer provides smooth operation while the proprietary heat treating extends its life 5-10 times longer than similar designs.



6575-2 Hub Tamer™ to Grappler Update Kit

- This kit includes everything to update the previous Hub Tamer Kit to the New Hub Grappler kit.
- Includes the Hub Grappler Puller, 6 new adapters, misc. hardware and the new Hub Grappler Application Guide.

6575-2C

- Same as above, also includes Hub Grappler case 6575-4.



6575-3 Hub Grappler™ Hydraulic Kit

- The Hub Grappler Hydraulic Option is an economical way to increase the performance and speed of wheel bearing and hub service.
- Kit includes a through hole 9-ton ram, OTC 2510A air/hydraulic pump, 6 ft. hose with couplers, drive screw and nut.



6575-4 Hub Grappler™ Case

- Fits the Hub Grappler puller and adapters.



6575MAN-09 Hub Grappler™ Application Guide

- The Hub Grappler Application Guide is the most comprehensive hub and bearing service guide on the market. Developed to be the first tool used in the kit, it provides quick reference to the other tools in the kit required to do the job, eliminating guesswork and saving time.
- Comprehensive application guide includes diagrams and instructions showing how and where every adapter is used from 1996–2009.
- Application Chart references front/rear, hub/bearing removal and installation adapter part numbers based on vehicle make, model, and year.
- Application Diagrams show puller and adapters properly mounted on steering knuckle with p/n call outs, eliminating trial-and-error.

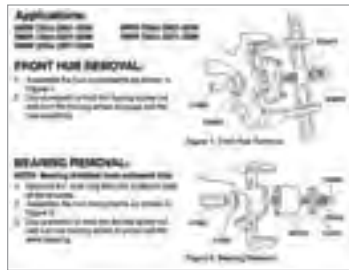

Samples of Application Diagram and Chart.



6290A Front Hub Puller for 4WD Vehicles

- For removal of the front hub assembly, necessary for wheel bearing or brake rotor service. Provides the mechanical advantage and straight pull not possible with a slide hammer.
- Will not work on trucks with dual rear wheels.

Services:

- 1988–2014 GM 1/2-ton, 3/4-ton, and 1-ton trucks, Tahoe, Suburban, and Yukon.
- 1994–2014 Dodge 3/4-ton and 1-ton Ram trucks.
- 1998–2014 Ford 3/4-ton and 1-ton trucks, Excursion.



7901 Front Hub Puller for 4WD Vehicles

This puller is required for removing a front hub assembly in 3/4- and 1-ton 4WD pickups with 8-bolt hubs. It works on 1994 to 2014 Dodge Ram and 1988 to 2014 Ford and GM.

- Fits bolt hole pattern 8 x 6.5".
- Will not work on trucks with dual rear wheels.
- Use with our No. 7703 10-lb. slide hammer for maximum pulling force.



6574 Universal Hub Puller HD with Plate

- Universal Hub Puller HD – the “Final Answer” to frozen hubs, axle shafts, and other tough pulling applications.
- Adjustable sliding puller legs can be positioned anywhere on the puller center hub for a true universal fit on wheel hubs with 5"-8"+ bolt circles.
- Pulling plate allows for quick attachment and an even pull on the popular 5 bolt hubs with 4"-5" bolt circles.
- Forged puller assembly coupled with a 1" drive screw capable of 20 tons of force.
- Drive screw approved for use with an impact gun and can be struck with a hammer.
- Additional puller legs may be added to the center hub for special applications.



7394 Universal Hub Puller

With its adjustable sliding arms, this puller makes wheel-hub removal quick, easy, and damage free. It has maximum bolt circle of 7-1/2".

- The No. 32937 puller leg is available separately to complete the five necessary for Cadillac and Jeep hub removal.
- Includes striking wrench and puller screw.

32937 Puller leg

6574-1 Puller Plate Optional Puller plate with screws for 7394.



7208A Hub remover to push the axle shaft from the front hub.

7135A Installer is used to pull the axle shaft into the front hubs on Ford Taurus/Sable vehicles. Fits axle shafts with 20 mm x 1.5 thread.

7924A Installer is used to pull the axle shaft into the front hub. Fits axle shafts with 22 mm x 1.5 thread on Ford Contour/Mystique, Probe, and Focus.

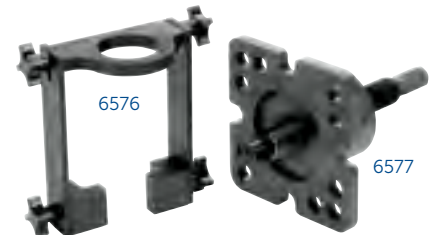

6576S includes both 6576 & 6577

6576S Dodge Hub Service Set

- Removes stubborn hubs, using 2 methods.
- First, the 6576 Hub Pressing Tool is used to press off the hub with the aid of the power steering. The tool locates spacers between the U-joint yoke and axle housing. Unique design makes this a one person operation to remove the hub with the bearing in tact.
- In the event the Hub Pressing Tool does not budge the hub, the 6577 Hub & Bearing Housing Puller is used. This may separate the bearing, but the unique dual pattern design fits both the wheel hub and bearing housing, capable of applying 20 tons of force.
- Will not work on trucks with dual rear wheels.

6576 Hub Pressing Tool, Fits Dodge 3/4 & 1 Ton 4WD 1994-Later applications.

6577 Hub & Bearing Housing Puller, Fits Dodge 3/4 & 1 Ton 4WD 1994-Later applications. Also fits GM and Ford 4WD Truck hubs.



Similar to Ford 202-405

Similar to Ford 205-404

7932 Ford Vacuum Front Hub Release Tool Set

Here's the equipment you need to safely remove the plastic vacuum hubs on Ford pickups. Standard tools won't work for the job, but this set has special clips that slip into slots on the hub to release it.

- For use on 1998 to 2000 4WD Ranger with vacuum front hubs.

6695

Similar to Ford
205-429



6697

Similar to Ford
205-830



6698

Similar to Ford
205-831



Ford Axle Shaft Seal Installers

Correctly installs the seal onto the axle shaft and into the wheel knuckle, preventing front hub vacuum leaks that would cause the 4WD to not engage.

6695 Ford Axle Shaft Seal Installer. Works on 1998-2004 Ford F-250, F-350, F-450, and F-550 4X4s having the vacuum-operated front axle.

6697 Ford Axle Shaft Seal Installer. Works on 2005-newer Ford F-250, F-350, 4X4s having the vacuum-operated front axle.

6698 Ford Axle Shaft Seal Installer. Works on 2005-newer Ford F-450, F-550, 4X4s having the vacuum-operated front axle.

8342

Hub Resurfacing Kit

- Fits your power drill to quickly sand rust off studs and mounting surfaces where it is important to have a clean and debris free surface.
- The tool features a 1/4" dia. shank and a stud clearance pilot hole that accepts up to 1/2" studs.
- Sanding pads attach with Half turn thread.
- Includes holder and five sanding discs.
- Run at speeds between 5,000 - 20,000 rpm or less for best results.



552948

10 pack of replacement sanding pads



6541

Pulling Hook

- This slide hammer puller attachment is used to remove seals, bearings, and other press-fit parts.
- Designed to be used with OTC No. 1155 (5 lb.) or No. 1156 (2-1/2 lb.) slide hammer, or other slide hammers having 5/8-18 threads.



27315

Pulling Hook

- This slide hammer puller attachment is used oil seals and bearing in situations where conventional methods won't work.
- Designed to be used with OTC No. 1155 (5 lb.) or No. 1156 (2-1/2 lb.) slide hammer, or other slide hammers having 5/8-18 threads.



6578

Pinch Mount Expander Kit

- For servicing struts, ball joints, or steering knuckles with pinch bolt mounts.
- Remove most stubborn struts and ball joints with ease.
- This separator mounts in the pinch bolt holes and drives the anvil into the pinch slot, expanding the mount for easy component removal.
- Use on aluminum or cast iron pinch mounts; includes 2 dowel sizes.

1181

Multipurpose Puller Set

This assortment of puller tools gives you a wide range of job versatility. You get a 5 lb. slide hammer puller, hub puller, two sizes of OTC Grip-O-Matic® jaw-type pullers, a bearing pulling attachment, plus a cross-bar gear and pulley puller, all contained in a handy plastic storage case.

Set No. 1181 consists of:

No.	Description
1177	Slide hammer puller with a 5 lb. hammer, 2-way and 3-way heads. Reversible: either two or three jaws may be used to handle both "inside" and "outside" pulling jobs.
7208A	Front hub puller for servicing front-wheel-drive cars. Includes a spare locknut, which permits use with a No. 1177 slide hammer for rear axle flanges.
1023	2-ton combination 2- or 3-jaw Grip-O-Matic puller. Has 3-3/8" max. reach, 4-3/4" max. spread.
1027	5-ton combination 2- or 3-jaw Grip-O-Matic puller. Has 5-1/2" max. reach, 7" max. spread.
7393	Bar-type gear and pulley puller with a 5-1/2" long screw. Includes two hex head cap screws, 3/8"-16 x 3" long. Spread range: 1-1/2" to 4-1/4".
1122	Bearing pulling attachment for use with No. 1027 and No. 7393 pullers. Has 2" max spread, 1/8" min. spread.

4579

9-Way Slide Hammer Puller Set

- Pulls flange-type rear axles and most front-wheel drive hubs.
- Internal and external jaws provide a variety of combinations to pull bearings, gears and seals.
- Two- and three-way cross blocks and cone provide the perfect jaw configuration for most jobs.
- Set also includes a grip wrench adapter and a dent puller attachment for sheet metal or other unique pulling requirements.
- Designed for use with other OTC 5/8"-18 thread slide hammer attachments.
- Packaged in blow-molded case.



4508

Professional Style Seal Puller

- Designed to remove oil and grease seals when servicing cars, SUVs, and light trucks without damaging the housing or bearing.
- Hook tips in two sizes and professional handle design allows removal of hard-to-get-at seals by getting under them.
- The tool is 12" long and the hook tip is double-secured (versus competitors' designs), for durability.
- An extra blade is included, and additional replacements (No. 4508-1) may be ordered.

4508-1 Replacement blade for 4508



(7208A)



(1122)



(7393)



(1177)

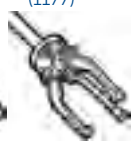

5 lb. Hammer in Polished Chrome Finish.





7948

Ten-way slide hammer puller set

- 2-3/8" Jaw (3 each)
- 3-3/4" Jaw (3 each)
- 6-1/2" Jaw (3 each)
- 3-Way Puller Head
- Adjusting Cone
- Hex Jam Nut, 5/16-24
- Hex Head Cap Screw, 5/16-24 x 11/8"
- 5 Lb. Hammer
- Shank and Tee Bar Assembly
- Cross Block
- Forcing Screw, 7/16-20 x 6.5"
- Puller Head
- Hex Jam Nut, 5/8-18
- Forcing Screw, 5/8-18 x 5"
- Sleeve
- Grip Wrench Adapter
- Dent Puller
- Retainer
- Self-Tapping Screw, 1/4" x 2"
- Puller Adapter
- Seal Hook
- Plastic carry/storage case



Bearing Cup Remover

Ideal for servicing hubs on today's popular front-wheel-drive small cars. The cone holds the jaws in place during pulling. Perfect for pulling internal bearing cups, seals, bushings, etc. Jaw spread: 15/16" to 3-1/4", reach to 3-1/2". Use with any slide hammer having a 5/8"-18 thread (OTC No. 1155 or No. 1156 or the No. 927 Push-Puller).

6542 Bearing Cup Remover

7136 Bearing Cup Remover. Similar to Ford 308-047.



Slide Hammer Rear Axle Puller

This puller will enable you to remove flange-type rear axles from most late model cars and light trucks. It works on axles having bolts and studs up to 9/16" diameter.

- Fits 4-, 5-, or 6-bolt patterns and stud circles from 4-1/4" to 5-9/16".

7372 Rear axle pulling plate.

7374 Rear axle pulling plate with 5-lb. slide hammer assembly.



4507

Bearing Race and Seal Driver Set (10 piece)

- This aluminum constructed set permits installation of tapered bearing races and seals without damage to the component or housing.
- Tapered side of driver is used to install races. Invert the driver to the flat side to install seals.
- Housed in a blow-molded plastic storage case.
- Includes driver handle with bolt, plus these tool sizes: 1.565", 1.750", 1.965", 2.325", 2.470", 2.555", 2.830", 2.995", and 3.180".

4406

Adjustable Bearing Race and Seal Driver

- Universal and fully adjustable.
- Twist head to adjustable from 3/4" to 3.5" (19mm to 89mm).
- Lock bolt holds jaws to preferred diameter.
- Steel striking cap mounted on aluminum handle and head provides a weight under 2 lbs.

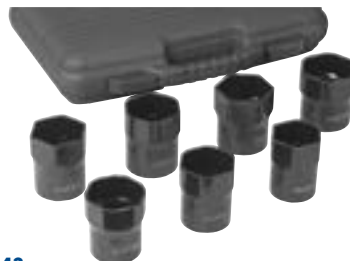

4542

7-Piece Wheel Bearing Locknut Socket Set

For use with 1/2" ratchet or breaker bar. Set contains:

- 519097-1 2-3/8" hex locknut socket** works on 1984-92 Ford Rangers and Bronco IIs with automatic locking hubs. Similar to Ford 205-040 (T70T-4252-B).
- 519097-2 2-9/16" rounded hex locknut socket** works on 1990-93 Dodge trucks with Dana 60 manual hubs.
- 519097-3 2-1/2" hex locknut socket** fits the hex nut found on rear axles and various front axle applications on light-duty trucks.
- 519097-4 2-3/4" rounded hex locknut socket** works on 3/4-ton and 1-ton Ford F-250 and F-350 trucks with automatic locking hubs. Similar to Ford No. 205-349 (T95T-1197-B).
- 519097-5 2-1/2" rounded hex locknut socket** works on 1995-96 Ford F-150 trucks and full-sized Broncos with automatic locking hubs. Similar to Ford 205-348(T95T-1197-A).
- 519097-6 2-3/8" rounded hex locknut socket** works on 1990-newer Ford Rangers, Bronco IIs, and Explorers with automatic locking hubs.
- 519097-7 55 mm hex locknut socket** designed for use on front wheel adjusting nuts found on Toyota models FJ, LN, and RN.



1912

6-pt. Locknut Socket

- This high-grade truck wheel bearing locknut socket is made of high-strength steel.
- NOTE: Sockets are designed for use with 3/4" square-drive manual tools only. Impact tool use voids sockets' warranty.
- Opening size (6 pt.) 3-7/8"

Similar to Ford 205-039 (T70T-4252-B)

1902

Locknut Socket - Ford

- Drive 3/4" (6 pt.) 2-3/8" Hex
- This high-grade truck wheel bearing locknut sockets are made of high-strength steel and resist rounding out.
- Services 1984-92 Ford Ranger and Bronco II with automatic hubs; 1993-1997 Ford Ranger, Bronco II, and Explorer with automatic hubs.
- For manual use only, impact wrench voids warranty.

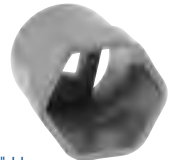

Similar to Ford 205-043 (T70T-4252-W)

Fits special "rounded" hex nut found on Dana axles of some Ford trucks. Depth of locknut sockets is 5".

1928

Locknut Socket - Ford, Dodge

- Drive 3/4" (6 pt.) 2-9/16" Hex
- This high-grade truck wheel bearing locknut sockets are made of high-strength steel and resist rounding out.
- Services 1990-93 Dodge truck with Dana 60 manual hubs. 3/4" sq. drive.
- For manual use only, impact wrench voids warranty.

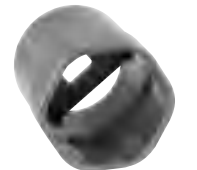

Fits special "rounded" hex nut found on Dana axles of some Ford trucks. Depth of locknut sockets is 5".

1936

Locknut Socket - Ford

- Drive 3/4" (6 pt.) 2-3/8" Hex
- This high-grade truck wheel bearing locknut sockets are made of high-strength steel and resist rounding out.
- Services 1990-newer Ford Ranger, Bronco II, and Explorer with automatic hubs.
- For manual use only, impact wrench voids warranty.

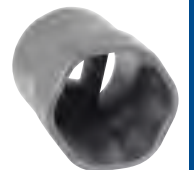

1-11/16" 43 mm



6006 Locknut Socket - Dodge

- Services 1994–newer Dodge 1/2-ton 4x4 pickups with Dana 44 front axle and Dana 60 axle with vacuum disconnect front axle.

6601 Locknut Socket - Ford

- Services 2003–newer Ford F-250, F-350, and F-450 Super Duty trucks with 10-1/2 inch rear axle.
- 1/2" sq. drive.

Similar to Ford 205-448



2-3/4" O.D.



2-1/4"

7157 Locknut Socket Ford, Dodge, GM

- Services 1993–newer Ford Ranger Bronco II and Explorer with manual hubs; 1995–96 Ford F-series 1/2-ton truck and full-size Bronco with manual hubs; 1995–newer Ford F-series 3/4-ton and 1-ton trucks with manual hubs; 1959–85 Ford F-series 1/2- and 3/4-ton trucks and full-size Bronco; 1960–90 GM 1/2-ton truck and full-size Blazer/Jimmy; 1969–89 Dodge 1/2-ton truck with manual hubs; 1969–72 International 1/2-ton truck.

- 1/2" sq. drive.

Similar to Ford 205-192 (T83T-1197-B)

7158 Locknut Socket Ford, Dodge, GM

- Services 1985-1/2–95 Ford F-series H.D. 3/4- and 1-ton Dana 50 IFS of Dana 60 front axle; 1982–90 GM H.D. 3/4- and 1-ton trucks, 1994–newer Dodge Dana 60 with Cummins.

- 1/2" sq. drive.

Similar to Ford 205-D065 (D85T-1197-A)



2-1/2"

7269 Locknut Socket Ford, GM

- Services 1985–newer Ford F-series 3/4- and 1-ton trucks with Dana 80 rear axle.

- 1/2" sq. drive.

Similar to Ford 205-282 (T88T-4252-A) Kent Moore J-42855



2-3/4"

7612 Locknut Socket Toyota

- 54 mm hex socket fits front wheel bearing adjusting nut of Toyota FJ, LN, and RN. Has 1/2" square drive end, permitting use of a torque wrench.

- 1/2" sq. drive.



2-1/8" 54 mm

7698 Locknut Socket Isuzu, Honda, Jeep

- Services 1988–1995 Isuzu Trooper, Rodeo, Amigo, and pickup; 1989–1995 Honda Passport; Jeep J20 pickups with Dana 60 axle.

- 1/2" sq. drive.



2-1/4"

7795 Locknut Socket Ford

- Services 1995–1996 Ford F-series 1/2-ton trucks and full-size Bronco with automatic hubs.

- 1/2" sq. drive.

Similar to Ford 205-348 (T95T-1197-A)



2-1/2"

7796 Locknut Socket Ford

- Services 1995–1998 Ford F-series 3/4- and 1-ton trucks with automatic hubs.

- 1/2" sq. drive.

Similar to Ford 205-349 (T95T-1197-B)



2-3/4"

7941 Locknut Socket Toyota

- Specially designed to fit 4WD lock-out hubs on Toyota's 1995–2002 Tacoma, and 1996–2002 T100 and 4Runner.

- 1/2" sq. drive.

Similar to Toyota 09318-12010-01.



2.366 center to center on pins

7090A Locknut Socket Ford, GM

- Services 1978–84 Ford F-series H.D. 3/4- and 1-ton 4WD trucks; 1973–81 GM 3/4- and 1-ton 4WD trucks.

- 1/2" sq. drive.

Similar to Ford 205-D001 (D78T-1197-A)



2-5/8"



2-3/8"

7270A Locknut Socket Ford, Dodge

- Services 1984–92 Ford Ranger and Bronco II with manual hubs; 1986–95 Ford F-series 1/2-ton truck; full size Bronco with Dana 44 front axle; 1990–93 Dodge trucks with Dana 44 automatic hubs.

- 1/2" sq. drive.

Similar to Ford 205-244 (T86T-1197-AR)



6612, 6921

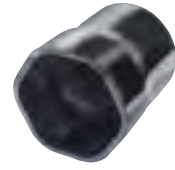

6796, 6928

- 6612** 54 mm hex locknut socket designed for use on front wheel adjusting nuts found on Toyota FJ, LN, and RN models.

- 6921** 2-1/2" hex locknut socket its hex nut found on rear axles and various front axle applications on light-duty trucks.

- 6796** 2-3/4" rounded hex locknut socket. Works on 3/4- and 1-ton Ford F-250 and F-350 trucks with automatic locking hubs. (Ford No. T95T-1197-B & 205-349).

- 6928** 2-9/16" rounded hex locknut socket. Works on 1990–93 Dodge trucks with Dana 60 manual hubs.



7217 Axle Nut Socket

- Designed to fit the axle nut on Chevy Topkick/Kodiak, 2003 - Newer.

- Similar to J-44275.



7218 Axle Hub Nut Socket

- Removes/installs the axle hub bearing retaining nut.

- Fits GM 11-1/2" rear axle found on 2011 and newer trucks.

- 9 Pin socket, 1/2" drive.

- Similar to CH-50636.



BRAKE

Brake Pad Gauge, Brake Fluid Tester	
Brake Drum and Rotor Puller	74
Brake Caliper Tools, Disc Brake Tools & Brake Spring Tools	75 – 76
Flare Nut Locking Pliers	76
Brake Flaring Tools, Tubing Cutters	77
Vacuum Brake Bleeder, Vacuum Pumps	
Bending Tools	78
Ball Hone Set, Brake Pressure Kit	79

WHEEL & TIRE

Tire Bead Seater,	
Dual/Single Wheel Separator	80
Tire Spoons	81
Tire Bead Breakers, Tire Service Hammers	82
Tire Spoon Holding Pliers, Hub Cap Removal Tool	83
Hands Free Air Chuck, Torque Wrenches & Wheel Dollies	84

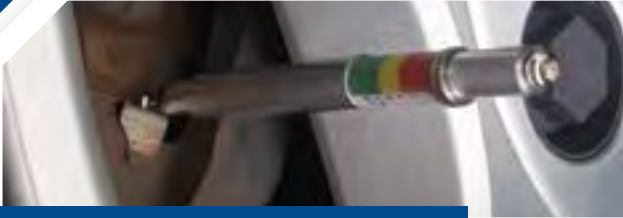

SPEED UP YOUR INSPECTION PROCESS.



6596 Brake Pad Gauge

- The 6596 Brake Pad Gauge allows for a definitive measurement of brake pads to determine remaining life.
- Unique design allows for measurement on the vehicle without the removal of any components in most cases (wheel assembly or brake caliper).
- Quick reference of brake pad condition via color code scale.

Barrel Measurement	Quick Reference Color	Brake Pad Condition
8 mm or more	Green	No replacement necessary
3 mm to 8 mm	Yellow	Suggest replacement soon
0 mm to 3 mm	Red	Recommend replacement



6980 Brake Drum and Rotor Puller

- Handles large components such as brake drums, rotors, drive wheels, gears, flywheels, and pulleys.
- One person can easily set the tool in place and use for tough pulls even where there is little access to insert the jaws.
- Spread to 12-3/4" and 5" of reach.
- 7-tons of force, yet weighs less than 10 pounds.
- Can be used with air tools to reduce time and fatigue.

• Tester ON; no water in brake fluid.

• Less than 1% water.

• Approx. 2% water.

• Approx. 3% water. Brake fluid should be changed soon.

• DANGER! At least 4% water. Immediately change brake fluid.

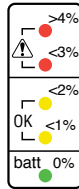

4598-DOT3



4598-DOT4

Brake Fluid Tester

- Tester determines quality of brake fluid.
 - One battery included: 1.5V AAA.
1. Remove cap from brake fluid reservoir.
 2. Remove probe cap from brake fluid tester.
 3. Press power button on top of tester. Green LED lights up.
 4. Dip entire length of metal probes into brake fluid.
 5. After one second, match color of LEDs with color chart to determine brake fluid quality.
- Tester automatically powers off after twelve seconds of inactivity.

4598-DOT3 Tester calibrated with DOT 3 fluid.

4598-DOT4 Tester calibrated with DOT 4 fluid.



6979 Brake Drum and Rotor Puller

- Designed for Medium/Heavy Duty Brake Drums/Rotors
- Accommodates brake drums and rotors up to 17.5" diameter
- Two screws included for standard and tall drum applications
- Puller reach is 12.25"



4589

Disc Brake Piston Tool

- This "cube" tool rotates pistons back into brake calipers when replacing brake pads on vehicles with rear wheel disc brakes.
- Tool has 3/8" square drive, provides six drive pin configurations to fit most cars and light trucks. This updated version fits more applications than many competitors' tools.



6093

Disc Brake Pad Spreader

- Can be used on or off the vehicle during brake pad replacement to push the piston back into the caliper. Thick pushing plate (3/16") and wide, threaded collars are designed for heavy-duty applications.
- Works on single and dual piston calipers.
- Slotted plate design provides universal fit on dual piston caliper applications.



6703-3

6703-2

6703-1

6703

Line Fluid Stopper Kit

Stop messy fluid leaks and prevent contamination during service.

- Kit seals all types of rubber and steel line found on fuel, brakes, AC, power steering and transmission system.
- Includes two banjo style fitting stoppers, two steel line stoppers, six line plugs, a line disconnect tool, and a long reach line pinch-off tool for hard-to-reach hoses.

6703-1 Banjo Line Fluid Stoppers, 2 pk.

6703-2 Steel Line Fluid Stoppers, 2 pk.

6703-3 Line Plug Fluid Stoppers, 6 pk.



Similar to Ford 206-D001

7034

Disc Brake Pad Spreader

- For use on all standard and four-piston caliper disc brakes.
- Retracts piston and holds pads snugly in place for easy assembly of caliper over rotor.
- An extremely rugged tool that's easy to use.



7317A

Disc Park Brake Caliper Tool Kit

Includes caliper piston adapter from 1-1/2" to 2-1/2" to service most Audi, Chrysler, Ford, GM, Honda, Jaguar, Mazda, Mitsubishi, Nissan, Saturn, Subaru, Toyota, VW, Volvo, Saab vehicles with 4 wheel disc brakes.



4743

Motorcycle Brake Caliper Spreader

- Compresses the brake pistons on most style calipers for easy pad replacement.
- Fits all front and some rear disc brakes.
- Range: .25" (5 mm) to 2.25" (58 mm). Works on all automotive applications in this range.



4799

Brake Piston Removal Locking Pliers

This specially designed locking pliers allows the removal of brake caliper pistons during service or rebuild. The pliers is simply clamped into the I.D. of the caliper piston allowing it to be pulled out of the caliper. Range; 5/8" to 2-1/4" diameter pistons.

**FOR PRODUCT
VIDEOS VISIT
OTCTOOLS.COM**



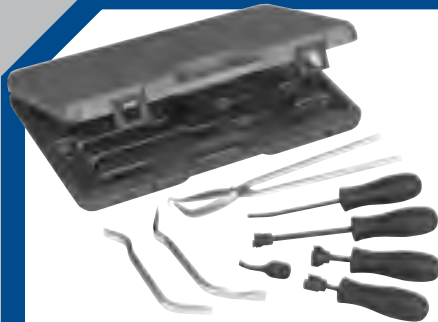

6516
Brake Tool Set (8 piece)

- Set contains the most popular brake tools for servicing drum brakes on many import and domestic vehicles.
- Includes three different brake spoons to adjust most brake drums, five different brake spring tools that will service most drum brakes.



4590
Brake Spring Pliers and Claw

- Effectively removes and replaces shoe return springs of drum brakes on domestic cars and trucks. Thin, narrow point provides straight, in-line pull on spring.
- Robust handle provides powerful leverage. Double-ended design. Plated steel resists corrosion.



4591
Brake Spring Compressor Tool

- Provides leverage to remove and install stubborn hold down springs of drum brakes on cars and light trucks.
- Special beveled cup end and notched design grips the retaining washers (11/16" to 7/8") used to hold the springs in place. Comfortable handle and knurled base for solid gripping.

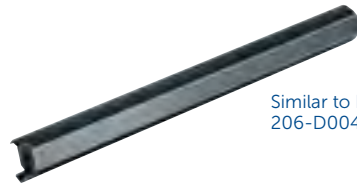

Similar to Ford 206-D004

7299
Ford Caliper Pin Remover

This is the damage-free way to remove brake caliper pins on 1986 to '88 Aerostar, Bronco, and E- and F-series pickups; 1983 to '88 Ranger; and 1984 to '88 Bronco II.

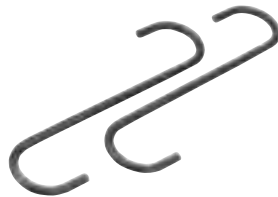

7661
Caliper Hanger Set

These hangers are designed to hold brake calipers out of your way during brake, bearing, suspension, or axle work. In doing so, they make the jobs easier and faster, and reduce possible brake hose damage.



7302-2

7302
Brake Caliper Pin/Bolt Remover Set

- Allows for removal of inboard facing pins or bolts to be removed from the outboard side of the brake caliper or vehicle component.
 - For caliper pin removal, simply back the pin bolt out half way and place the tool over the bolt shank to strike against the bolt head.
 - Fits all sizes of pins or bolt shanks ranging from 1/4" (6mm) to 5/8" (16mm).
- Set includes

- 7302-1** A striking version.
- 7302-2** Air hammer adapter.



6720
Flare Nut Locking Pliers Set (3 pcs.)

- Designed for use on new or damaged flare nuts that have been rounded or rusty.
- Fits Standard or Metric nuts and bolts.
- Angled jaws allow for clearance around frames and bulkheads.

6720-1 Covers 1/4" to 5/16" (6mm to 8mm).

6720-2 Covers 3/8" to 7/16" (9mm to 11mm).

6720-3 Covers 1/2" to 5/8" (12mm to 16mm).



6720-4
Flare Nut Locking Pliers

- Designed for use on new or damaged flare nuts that have been rounded or rusty.
- Fits Standard or Metric nuts and bolts.
- Angled jaws allow for clearance around frames and bulkheads.
- Covers sizes 11/16" to 7/8" (17mm to 22mm).



6722
Brake Spring Locking Pliers

- Designed to compress parking brake springs and hold them in a compressed position while servicing the brake cable or other brake components.
- Ford and Dodge applications.



- 4503**
Double Flaring Tool Kit
- Designed for double or single flare in copper, aluminum, soft steel brake line, and brass tubing (to 45 degrees).
 - Includes five adapters 3/16" through 1/2" (4.8 mm through 12.7 mm).
 - Chrome swivel, made of alloy steel, reduces friction. Forged yoke made of heat-treated steel. Housed in a blow-molded storage case.



- 4504**
Bubble (I.S.O.) Flaring Tool Kit
- Designed for crack-free bubble flares on soft steel tubing used in automotive brake systems.
 - Includes four dies: 4.75, 6, 8, and 10 mm adapters.
 - Forged steel yoke, flaring bar, and all the adapters needed for ISO bubble flaring.
 - The most economical "Bubble" flare tool to date. Housed in a blow-molded storage case.



- 6504**
Bubble (I.S.O.) Flaring Tool Set with Cutter
- Designed for metric, steel brake lines where an ISO or bubble flare is required.
 - Includes the No. 6514 tubing cutter and adapters for 4.75 mm, 6 mm, 8 mm, and 10 mm tubing.
 - Housed in a plastic blow-molded case.



- 6506**
Metric Double Flaring Tool Set with Cutter
- Designed for metric, steel brake lines where double flaring is required.
 - Also performs 45° single flares on 4 mm, 4.75 mm, 6 mm, 8 mm, 10 mm, 12 mm, and 14 mm copper, aluminum, brass, and magnesium tubing.
 - Includes the No. 6514 tubing cutter and adapters for double flaring 4 mm, 4.75 mm, 6 mm, 8 mm, and 10 mm tubing.
 - Housed in a plastic blow-molded case.



- 6503**
Double Flaring Tool Set with Cutter
- Designed for steel brake lines where double flaring is required.
 - Also performs 45° single flares on 3/16", 1/4", 3/8", 7/16", 1/2", and 5/8" copper, aluminum, brass, and magnesium tubing.
 - Includes the No. 6514 tubing cutter and adapters for double flaring 3/16", 1/4", 5/16", 3/8", and 1/2" tubing.
 - Housed in a plastic blow-molded case.



- 6502**
Master Brake Flaring Tool Kit
- Covers Single, Double, and Bubble type flares:
- Single Flare Standard Lines 3/16" - 1/2".
 - Single Flare Metric Lines 4mm - 14mm.
 - Double Flare Standard Lines 3/16" - 1/2".
 - Double Flare Metric Lines 4mm - 10mm.
 - Bubble Flare Standard Lines 3/16" - 1/2".
 - Bubble Flare Metric Lines 4.75mm - 10mm.
 - Kit contains flaring bar, arbor press, adapters, tube cutter, deburring tool, all in a hard case.



- 6514**
Mini Tubing Cutter
- Works on tubing sizes 1/8" to 5/8" O.D. (3mm to 16mm).
 - Easily cuts copper, brass, aluminum, and steel brake lines in hard-to-reach places.
 - Extra cutting wheel stored in knob.



- 6512**
Heavy-Duty Tubing Cutter
- Works on tubing sizes 1/8" to 1-1/8" O.D. (3mm to 29mm).
 - Easily cuts copper, brass, aluminum, and steel brake lines.
 - Reamer folds onto cutter body for storage.
 - Extra cutting wheel stored under reamer.



4403 Tubing Bender

- For 3/16" and 1/4" dia. tubing.
- Bend die approximately 1/2" radius.
- Can bend up to 180+ degrees.
- Quick release handle to easily remove tubing from bender.
- Sturdy steel construction.

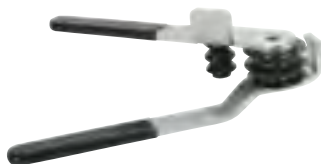

4404 Tubing Bender

- For 5/16" and 3/8" dia. tubing.
- Bend die approximately 3/4" radius.
- Can bend up to 180+ degrees.
- Quick release handle to easily remove tubing from bender.
- Sturdy steel construction.



6515 3-in-1 180° Tubing Bender

- Capable of making 180° bends in copper, brass, aluminum, and steel tubing.
- Just one tool works on three sizes of tubing: 1/4", 5/16" and 3/8".



4401 Tube Bending Pliers

- Bends tubing from the side allowing for use in limited access areas.
- 3/16" and 1/4" dia. tubing.

8106 Master Cylinder Auto Filler

- Automatically refills the brake fluid reservoir during brake bleeding.
- Base plate retaining clip provides positive attachment to all master cylinder reservoir types.
- Positive venting system supplies unbroken, continual fluid flow.
- Height adjustment allows user to maintain correct fluid level on all reservoir types.
- On/Off tap allows installation and storage without drips or spills.
- Suitable for use on any level controlled re-filling application (eg. clutches).



8101-SET Brake Bleeder/Fluid Evacuation with Auto Filler Set

This one man brake bleeding system allows for fast and efficient vacuum brake bleeding. The Vacuum Brake Bleeder/Fluid Evac. has a universal rubber fitting that holds securely on brake bleeder screw. Attach shop air and use the ball valve for on-demand vacuum and hands free operation. 6 L capacity.

The Master Cylinder Auto Filler automatically refills the brake fluid reservoir during brake bleeding. Base plate retaining clip and height adjustment allows fit on all reservoir types. On/Off tap allows installation and storage without drips or spills. 20 oz. (600ml) capacity.



8104A-SET Brake Bleeder with Auto Filler Set

This one man brake bleeding system allows for fast and efficient vacuum brake bleeding. The Vacuum Brake Bleeder has a universal rubber fitting that holds securely on brake bleeder screw. Attach shop air and use the quick release trigger for on-demand vacuum and hands free operation. Compact size and 17 oz. (500ml) capacity.

The Master Cylinder Auto Filler automatically refills the brake fluid reservoir during brake bleeding. Base plate retaining clip and height adjustment allows fit on all reservoir types. On/Off tap allows installation and storage without drips or spills. 20 oz. (600ml) capacity.



8104A Vacuum Brake Bleeder

This one man brake bleeding system allows for fast and efficient vacuum brake bleeding. Universal rubber fitting holds securely on brake bleeder screw. Attach shop air and use the quick release trigger for on-demand vacuum and hands free operation. Compact size and 17 oz. (500ml) capacity.



Fluid Evacuation/Brake Bleeding Tools

- Use to bleed brake systems and remove a variety of fluid from vehicles, such as antifreeze, oil, transmission fluid, gear lube, etc.
- Quick connect locking hose adapters and ball-style on/off valve on hose prevent fluid leakage.
- Equipped with a relief valve to prevent over-pressurizing the tank.

8100 Operates by shop air or a hand pump; shipped complete with a brake bleeding hose, fluid evacuation hose, and two suction hoses (6 mm and 7 mm); 10-liter capacity tank.

8101 Operates with shop air; shipped with a brake bleeding hose and fluid evacuation hose; 6-liter capacity tank.



**7488A
Brake Pressure Test Kit**

- Complete set of fittings and gauges for pressure testing ABS and conventional brake systems on Chrysler, Ford, GM, Jeep, and import vehicles.

Kit contains:

Two 0–3,000 psi gauges, 16 adapter fittings, two Bosch ABS adapters, one Teves/Delco Powermaster III adapter, one Ford (Teves) adapter, one 90° elbow fitting, one 45° elbow fitting, bleeder, organizer case and instructions.

7486 Gauge Assembly, 0–3000 PSI (1 only).



Similar to Kent-Moore J-35856

**7853
ABS Brake Proportioning Valve Depressor**

The proportioning valve depressor works on various GM utility vehicles, vans, and pickups fitted with Kelsey Hayes anti-lock brake systems. It also works on rear-wheel anti-lock brakes.

- Two depressors work best for four-wheel anti-lock systems.

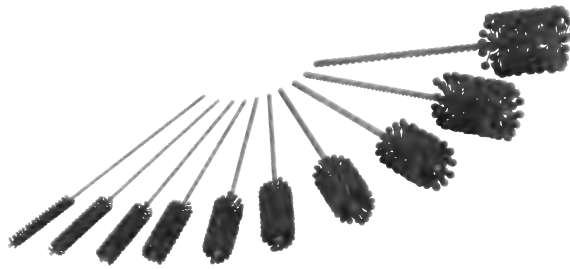

**7011
Ball Hone Set, 10 piece**

- Ball Hones can be used for refinishing and resizing bores such as found in brake calipers, engine lifters, and u-joint yokes. Also useful for any bearing or bushing application.
- All hones are 180 grit Silicone Carbide for excellent cutting and finish.

Tool No.	Size
7011-1	.375" 10 mm
7011-2	.500" 13 mm
7011-3	.625" 16 mm
7011-4	.750" 19 mm
7011-5	.875" 22 mm
7011-6	1.00" 25 mm
7011-8	1.25" 32 mm
7011-10	1.50" 38 mm
7011-12	1.75" 44 mm
7011-14	2.00" 51 mm



One-Man Brake Bleeder Hose

- Removes air from brake system, one wheel at a time, and eliminates the need for an assistant.
- Hose easily attaches to bleeder screw, which holds hose in place and prevents leaking.
- Check valve on end of hose prevents air from entering brake system when pumping brake pedal.

4599 One-man brake bleeder hose, one only.

4809 One-man brake bleeder hose, set of four. Do all the wheels at the same time. Includes four of the No. 4599.



**4546
Steering Wheel Holder & Pedal Depressor Kit**

- This kit has two applications: 1) holds steering wheel in position for alignment adjustments, and 2) depresses brake pedal for various brake checks, including brake lamp operation.
- Rod easily slides in actuator for fast, easy installation of tool on brake pedal or steering wheel. Simply hand squeeze the actuator to accomplish fine adjustments.
- Kit includes: actuator assembly; extension rod for actuator (use when depressing brake pedal); hook assembly (hooks on steering wheel when depressing brake pedal or holding steering wheel); and flat pad (rests on front seal when holding steering wheel).

4546-1 Handle and Rod.

4546-2 Steering wheel and pedal holder.





5713 Tire Bead Seater

The Tire Bead Seater is used when a tire, new or used, is mounted on a wheel and the tire bead does not touch both sides of the wheel, making inflation possible. The air trigger on this tool expels a tremendous burst of air that inflates the tire to seat it to the wheel rim. This allows the tire to be inflated to the recommended pressure through the tire valve.

- The Tire Bead Seater is equipped with unique configurations that enhance ease of use, productivity and safety for technicians looking to get the job done right every time.
- Unlike other options out there, the Tire Bead Seater's ASME certified 13-gallon tank is designed with a nozzle and valve connected via hose assembly, giving the user more control rather than requiring them to hold the weight of the tank.
- The trigger style discharge valve allows for optimum airflow control while allowing both hands to firmly hold the nozzle/valve assembly, critical for effective and safe use. Wheels and handle function in either the vertical or horizontal position for easy mobility and storage.
- Unique nozzle design significantly reduces "blowback recoil" and contains discharge holes strategically placed for optimum inflation of a wide range of the tire sizes and wheel diameters.
- Air valve included for filling tank, which also provides compressed air for filling the tire while seating the bead, optimum for on-the-road service.

All these unique features combine to provide an industry leading bead seater with multiple tire capacity (up to 5 tires) on one tank fill.



5702 Tire Bead Seater

The 5702 OTC Tire Bead Seater provides many of the great features of it's 5713 big brother, at a more economical price!

- The trigger style discharge valve allows for optimum airflow control while allowing both hands to firmly hold the tank/valve assembly, critical for effective and safe use.
- Unique nozzle design significantly reduces "blowback recoil" and contains discharge holes strategically placed for optimum inflation of a wide range of tire sizes and wheel diameters.
- Inline design allows for a comfortable distance from the tire and wheel while seating.
- ASME approved 2-gallon tank with inlet valve, pressure gauge, and relief pressure valve for safety.



5700A Accessory Tire Bead Seater

- Provides the ability to control the blast with both hands firmly on the nozzle assembly, increasing effectiveness and safety.
- Includes all the fittings to adapt the hose to most surge tanks found on tire changers. A tank hook is also included to hang the nozzle when not in use.
- Long 6-1/2' hose will reach all positions on the tire.

5735-PACK Tire Spoon Pack with Hang Rack

An upgraded pack of popular tire spoons features the 35" Double End Tire Spoon with Grip Grooves (5735 35G), 35" Curved/Flat Tip Curved Tire Spoon (5735-35) and 30" Curved Tire Spoon (5736-30), along with a FREE rack (5715) that can be hung on a toolbox or wall for easy organization.

*Tool chest not included



5715 Tire Spoon Rack

- Designed to hold OTC Tire Spoons by the handle upset.
- Also holds tools with 3/4" or smaller diameter shafts.
- Can be hung on end of tool box or mounted to the wall via holes on 16" center.



5789-PACK Tire Service Display

Includes 23 popular tools for changing a tire:

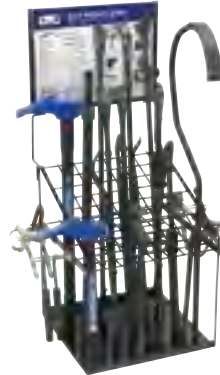

Part Number	Qty
5716	1
5720	1
5724	1
5728	1
5729	1
5731	1
5732	1
5733	1
5735-35	2
5735-42	2
5735-42K	1
5736-24	1
5736-30	1
5737-30	1
5739-24	1
5739-30	1
5758	2
5047LP	1
5789ID-520	1
5789ID-1032	1
5700-DISPLAY	1

5700-DISPLAY Hammer & Tire Service Display Rack

- Designed to display various products in the framed rack, complete with removable rear sign holder.
- Sturdy display framed with heavy 5/16" rod with heavy steel base eliminates tipping.
- Black powder coat finish for a rust free, durable finish.
- Contains 2" x 2" = 52 slots and 2" x 4" = 6 slots.
- Assembled dimensions; W 18.5", D 19", H 44".



5693 Dual/Single Wheel Separator

Quickly separate rusted, frozen or seized outside dual wheels or single wheels from the wheel hub. The unique outer drive hook has an offset handle to easily align the tool on the rim to break wheels loose, with a flat side to eliminate turning during use. Outer drive hook has two grooves for 16" - 17" wheels and 19.5" to 24.5" wheels. Force is applied directly to the wheel rim and not the wheel lip, preventing damage and bending of the wheel.

Includes four adapters to fit most wheel shapes and sizes: Dual wheel outer, long cupped dual wheel inner, short cupped single wheel and flat.





Convex Slip Head - Unique "Convex Slip Head" curved design allows the spoon to slide easily into the tire bead while the spoon bump limits the depth for quick-and-easy operation.



Grip grooves - Eliminate spoon slippage on the wheel rim while mounting or demounting the tire. The grooves also limit the depth of the spoon to help eliminate pinching tire tube applications.

5716 **HD Sliding Tire Spoon** 38" extends to 52", 3/4" diameter. Inner slide bar provides hammer action to easily insert and remove the spoon.



5716G **HD Sliding Tire Spoon with Grip Grooves** 38" extends to 52", 3/4" diameter. Inner slide bar provides hammer action to easily insert and remove the spoon.



5720 **Sliding Dual Tire Spoon** 35" and 3/4" diameter. Unique configuration provides mount and demount heads on either end with the aid of a slide hammer mounted mid bar, allowing for hammering either end in or out of the tire bead. Twist-lock feature locks 3.5 lb. slide weight in position.



5724 **Extending Tire Spoon** 22" extends to 34", 3/4" diameter. Twist-lock feature allows the spoon to be extended to any length and locked into position with a twist of the collar.



5734-18 **Tire Machine Spoon, Double End, 18"** Has a curved end and a bent tip end for starting the bead on a tire changing machine.



5734-18G **Tire Machine Spoon, Double End with Grip Grooves, 18"** Has a curved end and a bent tip end for starting the bead on a tire changing machine.



5735-18 **Double End Curved & Flat Tip Curved Tire Spoon, 18"** Double end curved tire spoon. Handle knob enables easier spoon pick up. 3/4" diameter.



5735-18G **Double End Tire Spoon with Grip Grooves, 18"** Double end curved tire spoon. Handle knob enables easier spoon pick up. 3/4" diameter.



5735-35 **Double End Curved & Flat Tip Curved Tire Spoon, 35"** Double end curved tire spoon. Handle knob enables easier spoon pick up. 3/4" diameter.



5735-35G **Double End Tire Spoon with Grip Grooves, 35"** Double end curved tire spoon. Handle knob enables easier spoon pick up. 3/4" diameter.



5735-42 **Double End Curved & Flat Tip Curved Tire Spoon, 42"** Same great design as the original double end mount/demount tire spoon, but in a 42" length for added leverage. 3/4" diameter.



5735-42K **Double End Tire Spoon with Kick Start, 42"** Includes kick loops to allow the spoon to be forced into tight bead locations with the help of foot pressure. 3/4" diameter.



5736-18 **Curved Tire Spoon, 18"** Handle knob enables easier spoon pick up. 3/4" diameter.



5736-18G **Curved Tire Spoon with Grip Grooves, 18"** Handle knob enables easier spoon pick up. 3/4" diameter.



5736-24 **Curved Tire Spoon, 24"** Handle knob enables easier spoon pick up. 3/4" diameter.



5736-24G **Curved Tire Spoon with Grip Grooves, 24"** Handle knob enables easier spoon pick up. 3/4" diameter.



5736-30 **Curved Tire Spoon, 30"** Handle knob enables easier spoon pick up. 3/4" diameter.

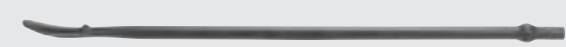

5737-30 **Flat Tip Curved Tire Spoon, 30"** Handle knob enables easier spoon pick up. 3/4" diameter.



5739-24 **Curved Shank Tire Spoon, 24"** The curved shank allows improved access for the spoon head around the tire bead or wheel rim. Handle knob enables easier spoon pick up. 3/4" diameter.



5739-30 **Curved Shank Tire Spoon, 30"** The curved shank allows improved access for the spoon head around the tire bead or wheel rim. Handle knob enables easier spoon pick up. 3/4" diameter.





5789ID-1032

5789ID-520

Tire Service Hammers, Indestructible Handle

- Indestructible handle - never needs replacement!
- Ergonomic rubber grip handle reinforced with steel bars resists breaking while absorbing impact and vibration.
- Drop-forged head is induction-hardened for long life, and contains steel locking plates that are specially bonded to ensure the head never becomes loose.
 - Use top hook as a wheel tipper; sledge end hook to drag tire into position.
 - Bead breaking wedge has grooves and a convex shape to help drive tire lube into the bead.

5789ID-520 5 lb. head, handle length 20", total weight 7.3 lbs.

5789ID-1032 10 lb. head, handle length 32", total weight 14.4 lbs.



5728 Tire Bead Breaker

- This tool will break beads in applications where other bead breakers have failed. A tire with a very weak or damaged sidewall due to a zipper rupture, or driven too far while flat, can be near impossible to break the bead with conventional bead breakers. Other applications like extremely soft sidewall tires, such as ATV tires, is where this unique bead breaker works and other do not.
- Unique head is designed to provide a large striking area for all angles, while providing the mass needed to break the tire bead.
- This design puts the force exactly where it's required and eliminates the possibility of accidentally hitting the wheel, problems typically encountered while using larger swing hammer style bead breakers.



5752 Wheel Loader & Tipper

- The new ergonomic wheel loader and tipper integrates two very helpful tools into one.
- The wheel loader feature allows a technician to lift various sizes and types of wheels and tires in and out of a truck bed.
- The wheel tipper feature allows the technician to flip a wheel over during tire service, or just tip up a wheel and tire to move.
- Both of these features allow the technician to easily and safely service and lift wheels by eliminating the need to bend over to lift, dramatically reducing the risk of back injury.
- Works on steel or aluminum wheels, inflated or deflated.



5750 Wheel Tipper

- This ergonomic wheel tipper allows the technician to flip a wheel over during tire service, or just tip up a wheel and tire to move.
- Allows the technician to easily and safely service wheels by eliminating the need to bend over to lift, dramatically reducing the risk of back injury.
- Works on steel or aluminum wheels, inflated or deflated.



5727 Sliding Bead Breaker

- The unique wedge design allows for consistent and accurate impact angle without adjusting the handle angle.
- The split head design provides wider tire force area while reducing drag on the wheel rim.
- Foot loops allows for extra foot pressure for bead breaking with fewer strikes.
- The head is also designed to tip tires from either side of the wheel. Includes wheel tipping slots to easily flip 250 lb. tires without hurting your back.
- Hammer shaft does not fall out of hammer body like competitive units.



5729 Outside Dual Wheel Bead Breaker

- Breaks the inner bead on the outside tire without removing the wheel from the truck.
- Unique design places pressure in the exact location required to quickly and easily break the inner bead.
- Simply pull up on the handle and the bead is forced off the wheel rim.



5047LP Lug Nut Cap Remover Locking Pliers

- Designed to remove lug nut caps found on heavy duty truck and trailers quickly and easily without damage. Caps can be easily damaged by prying or using standard cap removers.
- Locking pliers design with specially coated jaws apply maximum grip on the lug nut caps without damage.

5047 Lug Nut Cap Remover

- Chrome-plated lug nut caps found on many heavy-duty trucks and trailers can be tough to remove, and they're easily damaged if you pry them off or use an ordinary cap remover. This tool avoids those problems. It is ruggedly built and features specially coated jaws that won't slip off the caps, no matter how much squeezing force you apply.
- Features cushioned handles.





5731

Tire Bead Locking Pliers

- Prevents the tire from slipping while mounting the top bead.
- Quick and easy universal clamping design.
- Rugged rubber coated jaw to protect wheel finish.
- Prevents tire from contacting costly TPM Sensors.



5732

Tire Spoon Holding Pliers

- Tire Spoon Holding Pliers is the 3rd hand needed to ease mounting and demounting of tires with tire spoons.
- Quick and easy universal clamping design.
- Rugged rubber coated jaw to protect wheel finish.



5733

Tire Bead Wedge Pliers

- Tire Bead Wedge Pliers keeps the tire in the bead drop area to ease mounting and demounting of larger truck and agricultural tires.
- Quick and easy universal clamping design.
- Rugged rubber coated jaw to protect wheel finish.



7248

C-Frame Press

- The C-Frame used in conjunction with OTC Ball Joint Adapters. Can also be used for removing/installing; universal joints with needle bearings, pressed in wheel studs, and brake anchor pins on heavy-duty vehicles. Suitable for general pressing operations.

5726

Bead Breaking Tool

Designed to break down motorcycle, ATV and small garden tractor tires. The two-tool set includes a locking pliers and pry tool to quickly and easily break the bead. The locking pliers clamps to the wheel rim by forcing the wedged jaw into the tire bead. The pry tool incorporates a second wedge and a loop that quickly hooks to the locking pliers wedge jaw. The pry tool is then pushed down, breaking the tire bead.



5730

Motorcycle Bead Holding Pliers

Specialty locking pliers designed to hold the tire bead either up or down when mounting or demounting a tire. Clamp the non-marring pliers onto the wheel rim and use tire spoons to mount or demount the tire. The pliers eliminate the need to leave a tire spoon in position to hold the tire bead.

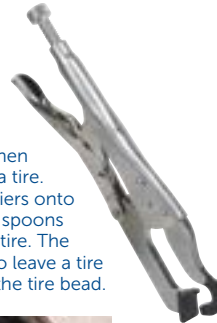

Motorcycle Tire Bead Holding Tool

This tool allows the tire bead to be held in the drop center of the wheel when changing the tire or installing an inner tube. The slot slides over the spoke and the opposite end is depressed to push the tire into position.

4777

For use on wheels with 1 5/8" maximum side profile height.

4775

For use on wheels with 3/4" maximum side profile height.



5758

Hub Cap Removal Tool

- Unique slide hammer design eliminates prying against the wheel finish and potential scratches.
- Opposite end has a rubber bumper used to re-install cap with a simple tab.

5758-1 Hub cap removal tool tip.

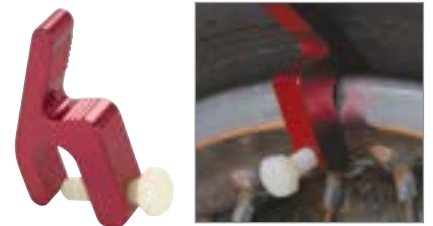

4771

Motorcycle Tire Bead Alignment Tool

This aluminum tool will hold a tire bead into the drop center of the wheel when changing the tire or installing an inner tube. The nylon thumbscrew will not damage the wheel finish.



4770

Motorcycle/ATV Tire Spoon with Grip

This 13" curved tip tire spoon is strong yet comfortable to use with the form fit hand grip. The rounded head prevents puncturing the tube.



4769

Motorcycle/ATV Wheel Rim Protector Set, 3 piece

Fits over the wheel rim to protect the wheel from being scratched or damaged while using tire spoons. Set of three.



5759

Bolt Circle Gauge

- Universal and fully adjustable.
- Measures 4, 5, 6, & 8 bolt patterns on wheels and hubs.
- Measurement units in Inches and MM.

WHEEL & TIRE SERVICE AUTOMOTIVE SPECIALTY TOOLS



5747 Tire Valve Stem Punch Kit

- Quickly and easily remove old valve stems from a wheel with a swing of a hammer.
- Simply place the punch tip on the inside of the valve stem and strike the punch to force the old valve stem out of the wheel.
- The unique punch tip is heat treated and shaped to remove all types of valve stems, including 10mm nickel plated, steel, and brass.
- Works on 412, 413, and 418 valve stems.
- Includes hand protecting grip with interchangeable 5" and 8" punch adapters for car and truck wheel applications.

5747-2 Tire valve punch tip, 5"

5747-3 Tire valve punch tip, 8"



5745 Hands Free Air Chuck

- Perfect for applications where the tire valve is facing the floor while seating the tire bead, such as most dual wheel configurations.
- Hooks on the top bead seat of the wheel and the spring pressure holds the chuck on the tire valve pointing to the opposite side.
- Ball valve included to allow inflation only when needed.
- Allows for safe tire inflation when used with a 6" to 8" inflation hose.

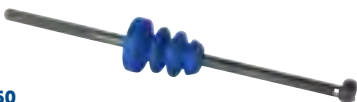

4750 Tire Valve Installer/Remove Tool

This 14" steel tire valve tool includes a stepped rubber sleeve that can be positioned on the handle for optimum pulling angle of the valve, while protecting the wheel finish. Removes and installs snap-in style tire valves.



5744 TPMS Tire Deflator/Locator;

- Evacuates air from the tire without removing the valve core.
- Tire location is marked on the color coded deflators so TPMS sensors can be replaced to the original location, eliminating the need for resetting.



4751 Tire Pressure/Tread Depth Gauge

This 3-in-1 gauge will measure tire pressure, lower tire pressure, and measure tread depth all in one gauge. Rugged cast housing for strength and long life.



5776 Preset Torque Wrench Set;

These color coded click torque wrenches are preset to the most common lug nut torque settings, making them perfect for tire shops.

- No need for adjustments
- Durable satin finish
- 1/2" Drive, 36 tooth
- Quick release ratchet head
- Perfect for Wheel / Tire shop
- Accuracy better than $\pm 3\%$ CW

Sold Individually:

5776-1 Preset Torque Wrench, 1/2" 65 lb-ft

5776-2 Preset Torque Wrench, 1/2" 80 lb-ft

5776-3 Preset Torque Wrench, 1/2" 100 lb-ft

5776-4 Preset Torque Wrench, 1/2" 120 lb-ft

5776-5 Preset Torque Wrench, 1/2" 140 lb-ft



5095A

Easy Lever Wheel Dollies

Gives technicians the leverage they need to easily remove or install truck tire-and-wheel assemblies.

- Heavy-duty construction capable of toting 300 pounds.
- Onboard rollers make stud-hole alignment a snap.
- Spring-loaded kickstand for handy parking.
- Rugged tubular steel construction.
- Two models that, together, can accommodate tire diameters from 24 to 48 inches.

5095A Easy Lever wheel dolly. With a width of 22", this dolly handles tire diameters of 24" to 36".

5096A Heavy-duty Easy Lever wheel dolly. With a width of 26", this dolly handles tire diameters of 36" to 48".



5096A

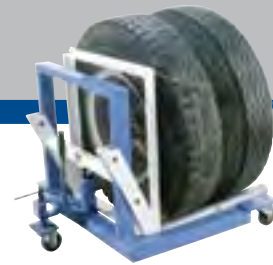

1770A 1,500 lb. Capacity Dual Wheel Dolly

- Hydraulic jack provides almost 5" of lift and tilts wheel assembly 4° to prevent damage to wheel seal.
- Independent lifting rack provides maximum stability; rollers won't catch on load.
- Swivel casters for easy maneuverability.
- 6' chain holds load in place.
- Covered by OTC Lifetime Warranty®.



5105B 1,100 lb. Capacity High-Lift Dual Wheel Dolly

- Effortless air-powered hydraulic lift system for a variety of applications.
- 0 to 42" lifting range.
- Six-inch lateral adjustment.
- Tilt adjustment of +15° to -8° ensures easy alignment.
- Features four swivel casters, two locking, for enhanced mobility.



5100 Wheel Mate™ Wheel Handler

- Enables truck technicians to easily remove, install, rotate, and transport single tire-wheel assemblies. Internal ratcheting jack with 14 inches of vertical travel —almost a foot higher than conventional dollies.
- U-shaped chassis that provides close, unhindered access to work area.
- A design that accommodates—and securely holds—almost any truck wheel, including wide-based singles, without restraining chains.
- Heavy-duty ball-bearing wheels mounted under ball bearing swivel casters for maximum maneuverability.
- Foot-operated wheel lock.
- Rugged structural steel tubing construction that meets the demands of the toughest shop environments.

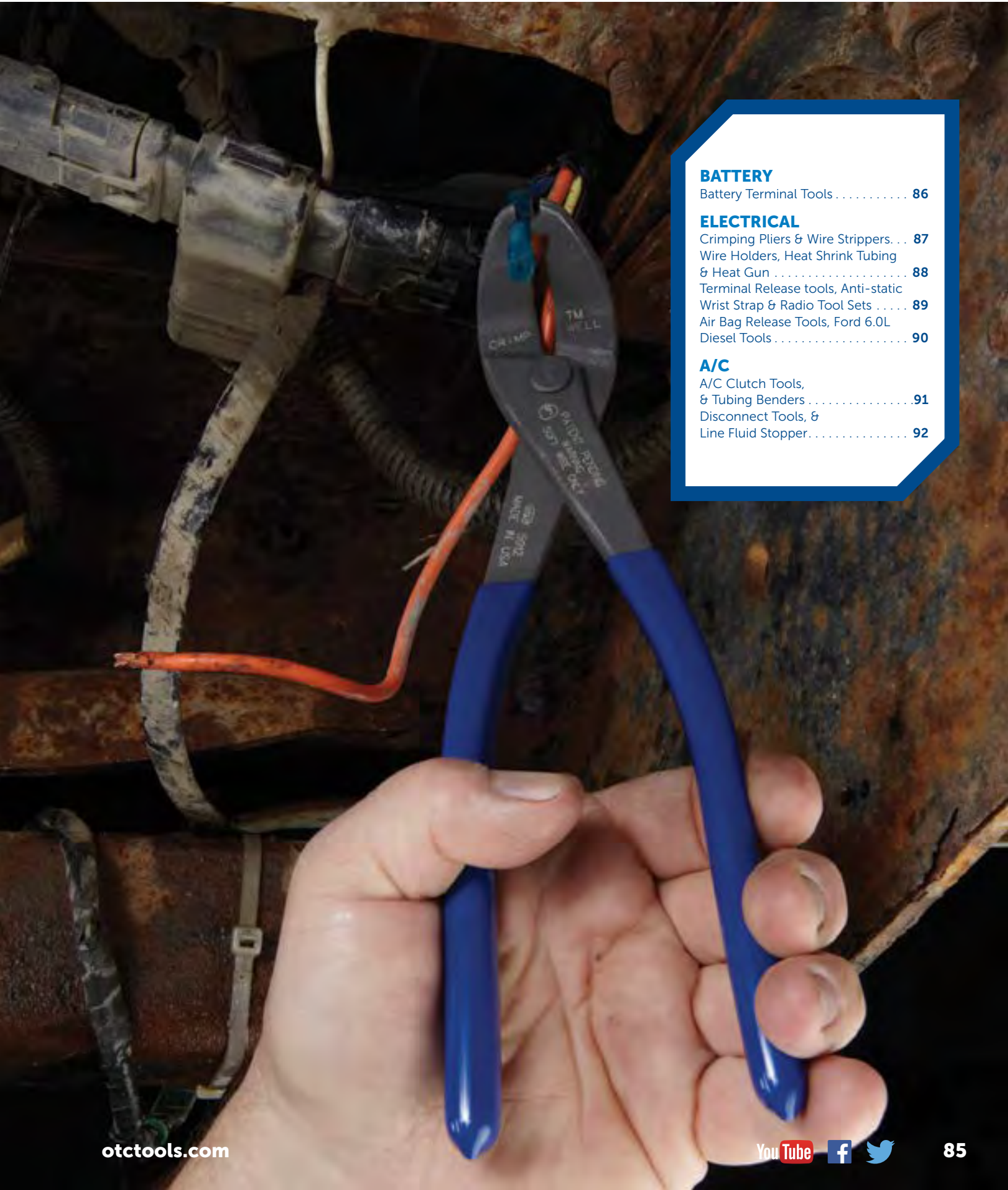

BATTERY

Battery Terminal Tools 86

ELECTRICAL

Crimping Pliers & Wire Strippers . . . 87

Wire Holders, Heat Shrink Tubing
& Heat Gun 88

Terminal Release tools, Anti-static
Wrist Strap & Radio Tool Sets 89

Air Bag Release Tools, Ford 6.0L
Diesel Tools 90

A/C

A/C Clutch Tools,
& Tubing Benders 91

Disconnect Tools, &
Line Fluid Stopper 92

BATTERY SERVICE AUTOMOTIVE SPECIALTY TOOLS



4611 Battery Terminal Puller

- Designed to remove the battery cable clamp from the post without causing damage to the battery.
- Spring-loaded sharp jaws get under the clamp for a secure grip.

4612 3-Way Battery Post Cleaner

- Steel blades quickly clean top-post battery terminals and cable clamps; cleaners are marked "positive" and "negative."
- Ream is tapered to clean both positive and negative battery cable clamps.



4613 Battery Pliers

- Serrated jaws firmly grip the battery terminal nut or bolt.
- Offset handles allow access in hard-to-reach areas.
- Works on top-post and side-post battery terminals.



4614 Side Terminal Battery Wrench

- Designed for use on GM side-terminal batteries, or any 5/16" hex head battery bolt.
- 5/16", 6 point, box end, 5-1/2" long, ratcheting wrench; insulated handle.



4615 Long-Side Terminal Battery Wrench

- Designed for use on GM side-terminal batteries, or any 5/16" hex head battery bolt.
- Long handle allows access to hard-to-reach battery terminal bolts.
- 5/16", 6 point, box end, 10" long, ratcheting wrench; insulated handle.



4616 Battery Terminal Wrench – 10mm

- Designed for use on 10 mm battery terminal bolts found on many import and domestic vehicles.
- 10 mm, 12 pt., box-end ratcheting wrench; 5-1/2" long with insulated handle.



4617 Side Terminal Battery Brush

- Designed to clean corrosion from side post batteries.
- One brush used to clean battery terminals; other brush used to clean battery cable ends.
- Plastic handle resists battery acid.



4618 Battery Brush

- Cleans dirt and corrosion from positive and negative battery posts and cable clamps.
- Plastic case resists battery acid and most cleaning solvents.



4619 Professional Battery Hydrometer

- Displays a battery's specific gravity on an easy-to-read float; scale ranges from 1.100 to 1.300.
- Thermometer indicates what must be added or subtracted from the float reading to arrive at an accurate specific gravity reading for each battery cell.
- Flexible tip offers easy access to the battery cells while the battery is still in the vehicle.

4620 Battery Carrier

- Use to lift and install most top post and side terminal batteries.
- Designed to transfer lifting force to a secure hold on the battery; teeth on jaws offer a secure grip.
- Vinyl strap resists battery acid and will not conduct electricity.



4621 Two-Liter Battery Filler

- Replenish battery water the easy way! The fill nozzle on this container has an automatic shut-off that prevents overfilling; the handle on the side of the container makes the job a snap. Container holds up to two liters of distilled water.

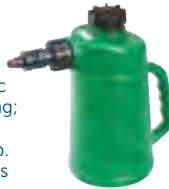

4622 Battery Cable Cutter

- Designed to cut copper battery cable and aluminum electrical cable. **IMPORTANT:** Do not cut steel cable; damage to blades will occur.
- Precision-ground cutting blades provide a clean, square cut.
- 7" long handle gives extra leverage when cutting.



4477 3/8" Cable Cutters

- Perfect choice for cutting heavier copper and aluminum cables.
- This tool is especially valuable for battery service where replacing a terminal is required.
- Clean cut with minimal mashing of wire strands.



4639 Battery Terminal Service Kit (7 piece)

- 4611 – Battery terminal puller.
- 4612 – 3-way battery post cleaner.
- 4613 – Battery pliers.
- 4614 – Side terminal battery wrench.
- 4615 – Long-side terminal wrench.
- 4616 – Battery terminal wrench - 10mm.
- 4617 – Side terminal battery brush



4631 Battery Terminal Service Kit (8 piece)

- Kit includes:
- 4611 – Battery terminal puller.
 - 4612 – 3-way battery post cleaner.
 - 4613 – Battery pliers.
 - 4614 – Side terminal battery wrench.
 - 4615 – Long-side terminal wrench.
 - 4616 – Battery terminal wrench - 10mm.
 - 4617 – Side terminal battery brush
 - 4622 – Battery Cable Cutter

7645 Parasitic Draw Test Switch

- Finding electrical problems that drain the battery is getting harder all the time. But using No. 7645 with your digital amp meter takes the guesswork out of a complicated job. Attach the test switch between the negative battery cable and the battery, and then road-test the vehicle. Next, connect an amp meter to the switch to determine the parasitic amperage draw, and locate the excessive electrical drain on the battery. Works on any vehicle with side- or top-post batteries.



6945 Parasitic Draw Test Switch

- Test switch is used with an amp meter to isolate parasitic amperage draws on all GM vehicles or any vehicle with a side- or top-post battery. This tool attaches between the negative battery lead and the battery, then the vehicle road is tested. The next step is to connect an amp meter to each side of the switch, thereby allowing all available current to pass through the meter. Fuses are then removed one at a time until the circuit source of the parasitic draw is located. Similar to J-38758.





5950K

CrimPro™ 4-in-1 Wire Service Set

CrimPro™ 4-in-1 Wire Service Set includes both the OTC 5950S CrimPro™ 4-in-1 Wire Tool and OTC 5950A CrimPro™ 4-in-1 Angled Wire Tool.

5950S

- Compact 7-inch design used 4 ways.
- Gripping nose - to pull, twist, bend, and shape.
- Crimper - crimps 12-20 AWG insulated and non-insulated wire.
- Stripper - strips 12-20 AWG wire.
- Cutter - ability to make cuts below pivot.

5950A

- The angled feature allows access to close quarters and facilitates superior crimps.
- Compact 7-inch design used 4 ways.
- Gripping nose - to pull, twist, bend, and shape.
- Crimper - crimps 12-20 AWG insulated and non-insulated wire.
- Stripper - strips 12-20 AWG wire.
- Cutter - ability to make cuts below pivot.



4468

9" Self Adjusting Wire Stripper

- Strips insulating sheathing from wires ranging from 10 ga. to 22 ga.
- Easy-to-use, just insert wire and squeeze.
- Also cuts and crimps.



4497A

Ratcheting Terminal Crimper

- Heavy-gauge steel crimping tool designed for insulated wire terminals.
- Ratcheting action crimps terminal to correct tightness on the wire, making crimping fast and easy.
- For wire sizes: AWG 22-18 (0.6 mm-1.0 mm) red terminal; AWG 16-14 (1.3 mm-1.6 mm) blue terminal; AWG 12-10 (2.0 mm-2.6 mm) yellow terminal.
- Insulated handles with compound mechanical leverage for power.



5912

Crimpwell™ Angled Crimping Pliers

- Universal crimping design accommodates soft wire - solid or stranded - 10-22 AWG.
- Cutting feature included for quicker preparation.
- 9" (228mm) in length, with protective grips to increase leverage and secure crimp.
- Angled design keeps the connector, the wire, and the crimper "in-line" -improving visibility and access in hard to reach places.
- Designed to not pierce connector insulation and also works on un-insulated connectors.
- Service tech can use as much force as desired to ensure connection and it will not damage connector insulation.
- Easy-to-use: Simply insert the connector into the crimping feature, slip over the connector and squeeze.



4467

Automatic Wire Stripper

- Quick removal of insulation on wire AWG 12-20.
- Comes with adjustable depth gauge (8mm to 12mm).
- Sharp v-shaped tooth easily removes insulation without any damage to soft wire strands.
- Cutting tool stored below the stripper.
- Features a space saving locking mechanism for pockets or tool drawer storage.



4498A

7-in-1 Wire Stripper and Crimper

- Strips insulation off electrical wires ranging from 10 AWG-22 AWG (0.6mm-2.6mm) in diameter. Pliers on tip of jaw for looping or grabbing wire in tight places.
- Heat-treated steel jaws cut solid or multi-strand wire.
- Screw cutter shears screws clean, with no thread clean-up required. Works on machine screw sizes 4-40, 5-40, 6-32, 8-32, 10-24, and 10-32.
- Crimps insulated and non-insulated wire terminals, 7mm-8mm spark plug wire connectors.



4484

Weather Pack Ratcheting Crimper Kit

Manage environmentally-sealed connection systems with the OTC 4484 Weather Pack Crimper Kit. Weather pack connection systems are designed to protect against exposure to heat, moisture and contaminants. Includes:

- Two interchangeable crimping dies coverage wire range AWG 22 / 20-18 (DIN: 0.35 / 0.5-0.8mm) and AWG 16-14 / 12 (DIN: 1.0-2.0 / 3.0mm).
- Dies are magnetically secure and easily changed.
- Instructions clearly illustrate how to create a weather-proof seal.
- Connections found on motorcycles, Class 7 - 8 tractors, automobiles and more.

4484-1 Ratcheting Weather Pack Crimper Chassis

4484-2 H6 Die AWG: 22/20-18 (Din 0.35/0.5-0.8 mm²)

4484-3 H7 Die AWG: 16-14/12 (Din 1.0-2.0/3.0 mm²)

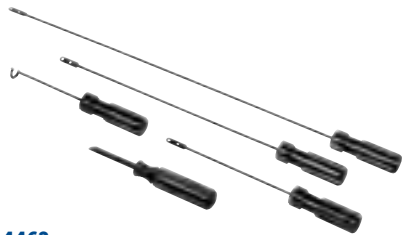
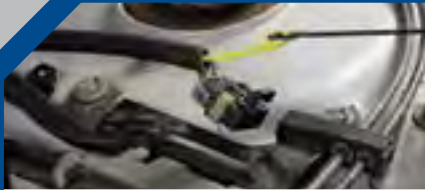

4462 Wire Loom Threading Kit

The 4462 Wire Loom Threading Kit from OTC is a clever grouping of wire fishing tools for the automotive technician. Whether general wiring R&R - or adding Gauge Packs, Sound Systems, Vehicle Security and Camera Systems, these tools simplify placing the wiring within the protection of existing wiring looms, without cutting tape or zip ties and without damage to other wires.

There are 3 wire pulling tools in 15", 10" and 5.5" lengths for common automotive applications, the grommet insertion tool allows the wire to be captured within the tool to hold once it is placed, so you can grab from the opposite side of the firewall - and the pigtail tool assists when building a new harness on the workbench.

5953 Dual End Wire Holder

- Holds wire and connectors solidly during soldering or other wire service.
- Unique design allows connection to be held firmly on both sides with infinite adjustability.
- Insulated clips act as heat sinks to protect shrink tubing or other sensitive parts from heat.



5955 Magnetic Clamp Wire Holder

- Holds wire and connectors solidly during soldering or other wire service.
- Unique design allows connection to be held firmly on both sides with infinite adjustability.
- Insulated clips act as heat sinks to protect shrink tubing or other sensitive parts from heat.
- Clamp with magnet allows for attachment to a work bench, vehicle, or any other object for a firm base.



4472 Cordless Solder Tool Kit

- Cordless, hands-free operation.
 - Safety switch prevents inadvertent ignition.
 - Fuel-level sight window.
 - Use as a - solder tool, heat tool or an torch tool.
- Kit Includes: Soldering iron, conical tip 2.4 mm, chisel tip 2.4 mm, hot knife tip, deflector tip, sponge, wrench, and soldering wire.

4470 Butane-Power Flameless MicroTorch

- Cordless 650° (1250°F) flameless heat.
- Waterproof piezo electronic ignition with locking trigger.
- Refillable fuel cell uses standard butane lighter fluid (butane NOT included).
- Ideal for automotive and heat shrink projects.



4822 Wire Connector Tool Set, 2 Piece

Designed to remove terminals from connector housing without damage to the terminal or connector. Set provides 12 different tool styles fit most common connectors.

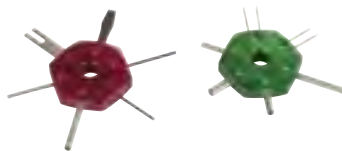

4782 Wire Pulling Tool

This tool contains an 18" cable with a "T" handle at one end and wire mesh at the other. By threading the cable through a difficult to reach area such as a motorcycle frame, wires or connector can be hooked to the end allowing the wiring to be pulled through.



4813 Heat Shrink Tubing Set (171 Piece)

Protection and insulation for solder connections and components. 2 to 1 shrink ratio with flame or heat gun.



4814 Waterproof Heat Shrink Tubing Set (106 Piece)

Waterproof protection and insulation on solder connections and components. Adhesive lined inner wall to seal out moisture. 3 to 1 shrink ratio with flame or heat gun.



4460 2-Piece Electrical Connector Separator Tool

- Releases locking tabs on electrical connectors, component connections & wiring harness connectors.
- Eliminates damage to the tab or connector.
- This pair of tools permits access to electrical connectors in any position.



4493
Angle-Tip Relay Pliers

- Designed to remove and install relays, which are usually located in confined, hard-to-reach areas.
- Specially coated tips offer a solid grip on the relay.



4448
Door Buzzer Shutoff Tool

- This simple tool allows for work with the vehicle door open without the annoying door buzzer on.
- High tension spring can be placed in the door jamb to close the door buzzer switch typically found by the hinges.



4712
Euro Radio Removal Tool Kit

- Includes the popular tools needed to remove the radio from the dash on the following European vehicles: BMW, VW, Audi, and Mercedes-Benz.
- Easily removes the radio without damaging the radio or the dash panel.



4461
Terminal Release Tool Set

- Save time and money. Repair or rebuild a wiring harness without having to order the entire OE replacement.
- Services most OE terminal connectors. Insert the appropriate release tool to depress the locking tab and the individual wire slides out for service or replacement.

Kit includes:

7737
Computer edge board and header release tool. Each end of the tool works on different terminal connector configurations. Works on various domestic and import models.

7738
Weather Pack sensor terminal release tool. Works on various domestic and import models.

7740
Micro-style terminal release tool. Works on various domestic and import vehicles.

7741
Specifically designed to release ID computer terminals on 1988 thru current GM W bodies, 1990 thru current Chevrolet Lumina sedans, and various other domestic and import vehicles.

7742
Universal harness release tool designed for the RWAL (rear wheel anti-lock) microprocessor found on 1988 thru current GM pickups. Also works on various other domestic and import vehicles.

7743
Releases terminals on most body wiring connectors on various domestic and import vehicles, including cold start injector and timer, water, O2, vacuum, and air temperature sensors.



4711
Deluxe Radio and Antenna Service Kit

- Eleven-piece kit in molded case.
- Universal antenna wrench.
- Ford radio removal tool.
- Deep sockets to remove and install the tamper-proof radio nuts from many GM, Chrysler, and other aftermarket radios.
- Antenna nut sockets cover most import and domestic antenna nuts.

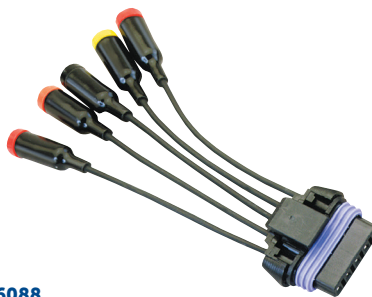

6088
Ford 5-pin Connector Harness for Glow Plug Testing

- Provides an easy way to check glow plug resistance without having to remove the valve cover of 1994–98 Ford trucks and vans with 7.3L DIT (direct-injected turbocharged) diesel engines.
- Used with any standard digital volt ohmmeter to check glow plug resistance.



4715
Deluxe European Radio Tool Set

- 18-piece set of tools used to remove radios on most European vehicles sold in the U.S. and Europe.
- Quickly and easily removes the radio from the dash without damage to the radio or dash.

Replacement Parts

- 4715-1** Removal Keys (4 pieces) Audi, Becker, Mercedes-Benz, VW.
- 4715-2** Removal Keys (2 pieces) Becker, Mercedes-Benz, Porsche.
- 4715-3** Removal Keys (2 pieces) VW.
- 4715-4** Removal Keys (2 pieces) Skoda.
- 4715-5** Removal Keys (2 pieces) Becker.
- 4715-6** Pentagon Wrench BMW.
- 4715-7** Bent U-hook (2 pieces) Blaupunkt.
- 4715-8** U-hook (2 pieces) Audi, Blaupunkt, Ford, Grundig, VW.
- 4715-9** Allen Hex Wrench BMW, Opel.



7744
Anti-Static Wrist Strap

Virtually eliminates the possibility of static electricity causing damage while working on electronic components.

- One-size-fits-most adjustable wrist strap.
- Includes a 6' coil cord with alligator clip.

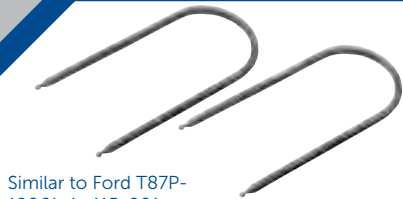

Similar to Ford T87P-19061-A, 415-001

**7575
Ford Radio Removal Tool Kit**

These dual-purpose tools release the retaining clips of a radio faceplate so you can pull the radio from the instrument panel. For use on 1987 to current Mustang; 1988 and newer Tempo/Topaz; 1989 to current Lincoln Continental; 1990 to current Taurus/Sable, Ranger/Bronco II, Probe, Lincoln Town Car, Mark VII, Crown Victoria/ Grand Marquis, Thunderbird/Cougar, F-series pickups and E-series vans; 1991 to current Explorer; 1995 to 2003 Windstar.



**5945
Air Bag Release Tool Kit**

- Use to remove the air bag module from the steering wheel.
- Work on many GM, Ford and Mercedes Benz vehicles.

Applications:

- Ford 2000-2004 Taurus/Sable, 1999-2003 Windstar Van.
- GM 1999-2005 Chevrolet Impala, Lumina, Monte Carlo, Venture, Pontiac Bonneville, Grand Prix, Montana, Buick LeSabre, Century, Regal, Olds Intrigue, Cadillac El Dorado, Deville, STS, SLS.
- Mercedes Benz Models 107, 123, 124, 126, 129, 140, 163, 164, 170, 201, 202, 203, 208, 209, 210, 211, 215, 219, 220, 221 and 463.



**6711
Mercedes-Benz Dashboard Service Tool Kit**

- 8-piece tool kit contains:
- (2) removal tools for ignition lock on model W126.
- (2) removal tools for ignition locks on models W124 & W201.
- (2) removal hooks for instrument cluster on models W107, W116, W123, W124, W126, W140, and W201.
- (2) radio removal tools on models W129, W140, W202, and W210.
- Covers virtually all Mercedes-Benz models since 1992.



**7956
Air Bag Simulator**

Ford air bag simulator. Special two-ohm resistor for use on 1993 and newer Ford system II air bags. When plugged into the vehicle harness connector, power is restored to simulate a complete circuit for diagnostic purposes.



Similar to Ford No. 303-1115

**6766
Ford 6.0L Diesel Terminal Release Tool**

This Terminal Release Tool is required for removal of the vehicle's injector wiring harness without causing damage to the component.



**6768
Ford 6.0L Glow Plug Release Tool**

Safely remove and install the glow plug harness on 2004-2009 Ford 6.0L Diesel engines.



**6764
Ford 6.0L Diesel IPR Controller**

- When a hard start or no start condition exists, the 6764 allows a technician to close the Injector Pressure Regulator in order to determine if proper injector control pressure is achieved and sustained for the starting process.
- Tactile On/Off switch with LED confirming power to the tool and signal to the Injector Pressure Regulator.
 - Permits a quick initial diagnosis of the pressure regulator when a hard start-no start situation exists.
 - Used in conjunction with any scan tool capable of reading fuel pressure on 6.0L Ford Diesel.



**7739
GM Code Retrieval Key**

- This key retrieves trouble codes from pre-OBD II model GM vehicles.
- ECM code retrieval key. Jumps between A and B terminals on ALDL connector to retrieve trouble codes from the ECM.



4536
A/C Clutch Pulley Puller Set

- For removal of stubborn air conditioning clutch pulleys. Also used on many alternator, generator, power steering, and crankshaft pulleys, harmonic balancers, and fiber timing gears.
- Set includes drop-forged components: one 3/4"-16 x 5" live-center forcing screw, 5-1/2" crossbar with three spread settings, two pairs of jaws, and a clamp bolt.
- Spread: 3" to 5"; Reach: 1" to 5".
- Includes blow-molded plastic case.

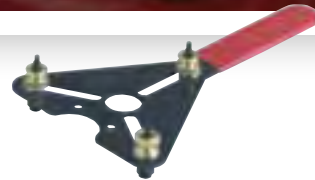

4537
A/C Clutch Holding Tool

This three-stud spanner wrench keeps the A/C clutch from turning when loosening or tightening the retaining nut. Adjusts quickly with brass thumbscrews to fit various styles of A/C compressors used on GM, Ford, and Chrysler vehicles. Also fits a variety of other pulleys.



6515
3-in-1 180° Tubing Bender

- Capable of making 180° bends in copper, brass, aluminum, and steel tubing.
- Just one tool works on three sizes of tubing: 1/4", 5/16" and 3/8".



4535
A/C Clutch Hub Remover/Installer Set

- For damage-free removal and installation of the clutch hubs on these air conditioning compressors: GM-Harrison DA-6, HR-5, V-5, A-6, and early R4; Nippondenso Ford/Chrysler A590, C171, FS-6, 6P148A (new style); Sanden & Sankyo; York/Tecumseh HR980; Zexel/Mitsubishi CH series.
- Set includes a removing flange, plus forcing screws and adapter assemblies to remove and install virtually all clutch hubs.
- Includes blow-molded plastic case.



6720-4
Flare Nut Locking Pliers

- Covers sizes 11/16" to 7/8" (17mm to 22mm). Fits nut sizes found on power steering and AC lines.
- Designed for use on new or damaged flare nuts that have been rounded or rusty.
- Fits Standard or Metric nuts and bolts.
- Angled jaws allow for clearance around frames and bulkheads.



6512
Heavy-Duty Tubing Cutter

- Works on tubing sizes 1/8" to 1-1/8" O.D. (3mm to 29mm).
- Easily cuts copper, brass, aluminum, and steel brake lines.
- Reamer folds onto cutter body for storage.
- Extra cutting wheel stored under reamer.



6514
Mini Tubing Cutter

- Works on tubing sizes 1/8" to 5/8" O.D. (3mm to 16mm).
- Easily cuts copper, brass, aluminum, and steel brake lines in hard-to-reach places.
- Extra cutting wheel stored in knob.

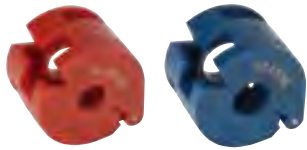

A/C spring lock coupling tool

Spring-loaded in the closed position to deflect any spray that occurs when lines are disconnected.

518900 – Red, 3/8" **518898** – Blue, 1/2"



A/C spring lock coupling tool

Spring-loaded in the closed position to deflect any spray that occurs when lines are disconnected.

518897 – Black, 5/8" **518901** – White, 3/4"



7238
Spring Lock Coupler Disconnect Set

Set includes four sizes for use on 3/8", 1/2", 5/8", and 3/4" tubes. Allows quick, safe disconnect of spring lock couplers on late model Ford systems and Tecumseh HR980 compressors.

518900 3/8" (red) Same as Ford 412-026 (T81P-19623-G1).

518898 1/2" (blue) Same as Ford 412-027 (T81P-19623-G2).

518897 5/8" (black) Same as Ford 412-038 (T83P-19623-C).

518901 3/4" (white) Same as Ford 412-040 (T85L-19623-A).



7242



7239

7242 A/C Spring lock coupler 1/2"

7239 A/C Spring lock coupler 3/4"

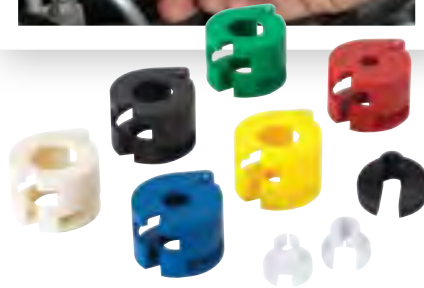
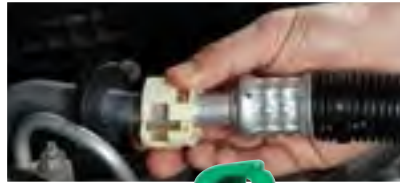

6517
Disconnect Tool Set

Designed for A/C lines, fuel lines, and transmission cooler lines.

- Contains 3/8", 1/2", 5/8", and 3/4" spring lock disconnect tools for A/C lines on Ford cars and trucks, Chrysler and Jeep vehicles.
- Contains the 3/8" and 1/2" fuel line disconnect tool for Ford vehicles.
- Contains the 5/16" and 3/8" fuel line disconnect tools for GM and Chrysler vehicles.
- Contains the transmission oil cooler line disconnect tool used on many GM and Ford vehicles.



6073
Toyota A/C Disconnect Tool

- Used to release the plastic quick-connect fittings on the high- and low-pressure air conditioning lines at the evaporator.
- Services 1998–newer Toyota Corolla, 1998–newer Geo Prizm, 1998-1/2–newer Toyota Land Cruiser and Lexus LX470, 1999–newer Toyota Avalon, Camry, Solara, and Sienna mini vans.
- Easy to use: Plastic fitting on A/C line is rotated to show access to the two release holes in the fitting; tool is inserted into release holes, and pushed to release the fitting.



6509
3/8" & 5/16" Fuel Line Disconnect Tool

Special low-profile design works in close quarters on GM, Ford, and Chrysler vehicles where there is limited clearance between the fuel line fittings and fuel filters, fuel rails, or sending units.



6508
Full-Coverage Disconnect Tool Set

If you're working on Chrysler, Ford, or General Motors vehicles, this set can make your job easier. The tools are designed for heater hoses, transmission oil coolers, air conditioning and fuel lines. They're approved by vehicle manufacturers and will not damage the fittings being disconnected. Tool Nos. 518902, 518896, 518897, 518898, 518899, 518900, and are spring-loaded in the closed position to deflect any spray that occurs when lines are disconnected.

SEE PAGE 27 FOR COMPLETE DETAILS



6703
Line Fluid Stopper Kit

Stop messy fluid leaks and prevent contamination during service.

- Kit seals all types of rubber and steel line found on fuel, brakes, AC, power steering and transmission system.
- Includes two banjo style fitting stoppers, two steel line stoppers, six line plugs, a line disconnect tool, and a long reach line pinch-off tool for hard-to-reach hoses.

6703-1 Banjo Line Fluid Stoppers, 2 pk.

6703-2 Steel Line Fluid Stoppers, 2 pk.

6703-3 Line Plug Fluid Stoppers, 6 pk.



4495
A/C and Fuel Line Disconnect Set

- Used to remove A/C and fuel line quick-disconnect fittings from hard-to-reach areas.
- Six sizes (5/16", 3/8", 1/2", 5/8", 3/4", and 7/8") available to work on many import/domestic vehicles.

BODY SERVICE

Trim, Upholstery, Door Panels, Mirror, 94 – 95
 Lockout Tools, Air bag,
 Windshield tools 95
 Hole Punch Kit, Punch Sets. 97
 Dent Puller. 97
 Collision Repair 98 – 99
 Pry Bars, Slide Hammers 100
 Radio Removal Tools, Hose Removal Sets 101
 Hammers, Wire Crimping & Stripping Tools. 102

FASTENER

Torx® Socket Sets 103 – 104
 Screw Extractor, Drilling Guide System. . . 104 – 105
 Impact Drivers, Thread Chaser, Battery
 Terminal Wrenches, Spanner Wrenches 106
 Torque Wrenches, Torque Multipliers,
 Torque Angle Gauges and Meter 107
 Giant Adjustable Wrenches, Strap Wrenches,
 Chain Wrenches, SmartTech™
 Technician Gloves 108

PLIERS & CUTTERS

Magnetic Pick Up Tool, Clutch Holder 109
 Retaining Ring Pliers. 110 – 111
 Hose & PVC Cutters, Hose Pinch Off Pliers,
 Angled Crimping Pliers 112
 Pry Bars 113
 Hose Removal Set, Pick & Hook Set,
 O-ring Picks. 114

STRIKE / STRUCK

Sledge Hammers 115
 Punch & Chisel Set, Bushing Driver Sets. . 116 – 117

GENERAL PURPOSE

Work Lights 117
 Holder, Ball Hone Set, Air Blow Guns,
 Universal Pulley Holder, Service Cart. 118





2549
Cigarette Lighter Socket Remover

Universal tool removes cigarette lighter socket without damage to socket or dash. Tool end lines up with the two tab windows of the lighter socket for easy, damage-free removal. Handle hole allows for easy hanging or can be used as leverage point for difficult to remove sockets. Similar to J-42059.



2550
Key Fob Fixture

Used for removal and installation of the key blade pins in GM flip key fobs when replacing the fob and retaining the original key blade. Includes holding tray and drift pin for use with a hammer. Eliminates damage to all parts. Similar to BO-51098.



6644
Door Handle Spring Retainer

This tool allows for door handle replacement without having to remove the interior door panel on 2014 and later Cadillac ATS and Escalade, Chevrolet Colorado, Impala, Silverado, Suburban and Tahoe models.

The tool installs into the door handle cavity and under the handle return spring to prevent it from unloading. Similar to BO-51363.



2551
Steering Column Anti-Rotation Pin

Installs into the steering column of most General Motors vehicles to keep the steering wheel orientation correct. Similar to J-42640.



2497
3 Piece Push Pin/Body Clip Pliers Set

Remove plastic body fasteners and clips faster in nearly any location. A set of three push pin / body clip pliers includes straight, 45° and 90° jaws to reach in wheel wells, under bumpers and behind the dash to remove retaining clips. The various jaw angles help access hard-to-reach places while providing maximum leverage to remove clips quickly and without damage. The unique design lifts the center pin and pulls body clips without damaging anchors, eliminating the need to provide replacement clips. Reusing these fasteners saves money and time searching for replacements of various shapes and sizes. The 3-piece set comes with an OTC lifetime warranty against defects in material or workmanship.



4492
E-Clip Tool Set, 5-piece

- Dual operation tool: one end of tool releases e-clip; other end of tool installs e-clip.
- Tools fit four sizes of e-clips: 6 mm, 7 mm, 8 mm, and 9 mm.
- Each tool easily locks into handle provided.



4549
Door Panel & Upholstery Tool Set
Heavy-duty door panel and upholstery tools

- 4549-1** Removes window and door handle clips, and upholstery tucking.
- 4549-2** V-notched door panel clip removal tool
- 4549-3** U-notched door panel clip removal tool



4551
Door Panel & Upholstery Tool Set
Heavy-duty U-notched and V-notched tools with stainless steel blades used for removing small door panels and upholstery clips.



4489
Trim Fastener and Molding Removal Set

- Set includes five different sizes and styles of tools that allow easy removal of trim fasteners, moldings, and wheel hubs.
- Tools are made of plastic to prevent damage to trim, moldings, alloy wheels, or vehicle paint.
- Can be used on trim fasteners and moldings inside, or outside, the vehicle.

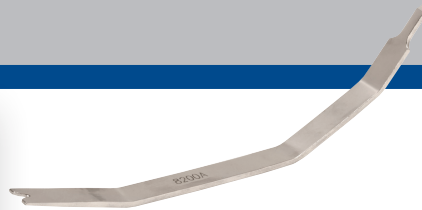

8200A
Ford Mirror Removal Tool

Save shop labor time and cost by allowing mirror to be removed without damaging or removing the mirror assembly.

Works on these outside door mirrors:

Windstar, Crown Vic, Grand Marq, Marauder, Taurus, Sable, Mustang, Town Car, Ranger, Excursion, Super Crew (F-250-F-550), F-650, F-750, Escape, Thunderbird, Explorer, Mountaineer, Expedition, Navigator, F-150, E-Series van, LS, Explorer Sport, Explorer Sport Trac, Aviator, Dual arm mirror used on Excursion, Super, Crew (F-250-F-550), F-650, F-750

- Also works on 1999 and newer Ford interior / rearview.



5945
Air Bag Release Tool Kit

- Use to remove the air bag module from the steering wheel.
- Work on many GM, Ford and Mercedes Benz vehicles.

Applications: Ford 2000-2004 Taurus/Sable, 1999-2003 Windstar Van, GM 1999-2005 Chevrolet Impala, Lumina, Monte Carlo, Venture, Pontiac Bonneville, Grand Prix, Montana, Buick LeSabre, Century, Regal, Olds Intrigue, Cadillac El Dorado, Deville, STS,SLS Mercedes Benz Models 107, 123, 124, 126, 129, 140, 163, 164, 170, 201, 202, 203, 208, 209, 210, 211, 215, 219, 220, 221 and 463.



6642
Trim Tool Kit, 11-Piece

Includes 11 specialty tools designed to remove trim strips, panels, wheel caps, bezels, liners, shrouds, fascia, and more...

- Tools are constructed of durable, impact-resistant nylon that will not damage non-metal interior trim surfaces.
- Cloth pouch rests flat on a dashboard or fender for easy access to tools and then folds up with tools inside for storage.
- Kit has multiple applications in the automotive, aviation marine, and other industries.



6785
Euro Door Handle Kit

- This kit contains the tools needed to service most door hinges and door handles on Audi, Mercedes-Benz, Porsche, and Volkswagen vehicles.
- Kit includes: A ratchet wrench with three 12-point bits (4 mm, 8 mm, 10 mm), one T40 and one T45 TORX® bit; a T30 TORX® long handled driver; and a T20 TORX® T-handle driver.
- T30 driver, 14" long; T20 driver, 9-1/2" long; hex ratchet, 9-1/2" long.



4680
Wiper Puller

The 4680 Wiper Puller from OTC has a unique design where jaws are forged with radius to hug the center screw for minimal spread, and for accessing recessed components. The radius also ensures optimal contact with object being pulled. It comes with 2 pair of legs - 9/16" width and 1" width - for many types of small component applications. The leg shoulders fit easily over the hex bar and can be snugged into position with a simple turn of a wing nut. Where there is minimal clearance, or deeply recessed access, the 4680 is a great tool choice to overcome these obstacles. Spread: 1" to 2-1/2"; Reach: 2-1/2". Lifetime Warranty.



4658
Windshield Spray Nozzle Needle

- Makes quick work of clearing obstructions from the windshield washer spray nozzle.
- Easily pierces corrosion or remove blockage.
- The barrel is knurled for grip and control.
- Threaded end caps keep the needle points covered when not in use. The pocket clip keeps the tool handy.



6676
Truck Windshield Wiper Puller, 18mm

- Designed to remove aluminum wiper arm from the steel stud that often galvanizes, locking the arm and stud together.
- Investment cast design is strong, easier to use, and saves time.
- Live center and more precise alignment save labor. Works on these and many other vehicles: Jeep Liberty, Grand Cherokee, Dodge Caravan, Stratus, Ram Diesels, Dakota & PT Cruiser, Chrysler LHS, Town & Country, Saturn Vue Buick Rendezvous, Cadillac CTS, Ford Focus, Ford Windstar, Honda Civic, Odyssey Toyota Camry.



4676
Windshield Wiper Puller

- Removes wiper arms on many foreign and domestic cars and light trucks.
- Will not damage wiper arm or hood cowl during removal.
- Simply place puller feet under wiper arm and tighten forcing screw against wiper shaft.



4448
Door Buzzer Shutoff Tool

- This simple tool allows for work with the vehicle door open without the annoying door buzzer on.
- High tension spring can be placed in the door jamb to close the door buzzer switch typically found by the hinges.



4449
Air Wedge Lockout Tool

- Air wedge is designed to create working room around the window frame when using other lockout tools.
- Adjustable inflation and release valve provides versatile use.



7956
Air Bag Simulator

Ford air bag simulator. Special two-ohm resistor for use on 1993 and newer Ford system II air bags. When plugged into the vehicle harness connector, power is restored to simulate a complete circuit for diagnostic purposes.



4452
Master Lockout Tool Set

Set includes:

- Lock Knob Puller
- Slide Lock Linkage Hook
- Under Window Knob Puller
- Under Window Lock Button Depressor
- Under Window Slide Lock Puller
- Lockout Wedge
- Porsche Lock Button Depressor
- Toyota/Chrysler Key Hole Lever
- GM/Ford Linkage Slider
- Ford Vent Window Lever
- Vent Window Button Depressor
- Vent Window Lever Puller
- Bell Crank Thin Bar
- Bell Crank Wide Bar
- Mercedes/Vovlo Lock Linkage Puller
- 119-2 Gas Cap Key.
- Instruction Manual



4450
Lockout Tool Set, 6-piece

Set includes:

- Lockout Wedge
- Lock Knob Hook
- Slide Lock Linkage Hook
- Toyota/Chrysler Key Hole Lever
- Vent Window Lever Puller
- Bell Crank Thin Bar
- Instruction Manual



4546
Steering Wheel Holder & Pedal Depressor Kit

- This kit has two applications: 1) holds steering wheel in position for alignment adjustments, and 2) depresses brake pedal for various brake checks, including brake lamp operation.
- Rod easily slides in actuator for fast, easy installation of tool on brake pedal or steering wheel. Simply hand squeeze the actuator to accomplish fine adjustments.
- Kit includes: actuator assembly; extension rod for actuator (use when depressing steering brake pedal); hook assembly (hooks on steering wheel when depressing brake pedal or holding steering wheel); and flat pad (rests on front seal when holding steering wheel).

4546-1 Handle and Rod.

4546-2 Steering wheel and pedal holder.



4485
Spot Weld Cutter Set

- Use with electric drill or air drill to cut 5/16" and 3/8" spot welds.
- Cutter bits have cutting teeth on each end.
- Replacement kit No. 4485-1 consists of (3) 5/16" cutter bits; (3) 3/8" cutter bits; and (4) centering tips.

4485-1 Spot weld cutter bits

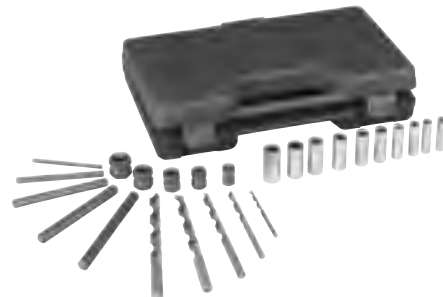

4651
Screw Extractor Set

- Removes broken studs and bolts.
- Includes ten guide bushings, five drill bits and five screw extractors with extractor nuts.
- Drill bits are left handed to help removal.



4602
Brass Punch Set (2 piece)

- Two large, brass non-sparking punches. Ideal for use near precision parts or in locations where sparks from ferrous metal could be hazardous.
- Includes an 8" punch (5/8" hex, tapered to 3/8") and 10" straight punch (3/4" dia., chamfered at both ends).



4606
Brass Hammer and Punch Set

- Brass-head hammer and punches are ideal to use where sparks from ferrous metals would be hazardous, or where precision metal parts could be damaged by steel tools.
- Hammer head weighs 24 oz.; brass drift punch is 10" x 3/4" diameter; brass tapered punch is 8" x 5/8" hex tapered to 3/8" diameter point.



6627
Grip Wrench Adapters

- For grip wrenches using single-lead thread adjusting screw.
- Adapter threads onto a slide hammer with a 5/8"-18 thread.

205378 Grip wrench threads onto a 7/16"-14 end of adapter for pulling use.

557479 Grip wrench threads onto a 5/16"-18 end of adapter for pulling use.

557480 Grip wrench threads onto a 1/4"-20 end of adapter for pulling use.



4383
Hole Punch Kit

- Easy, smooth operation. Will pierce up to 14 gauge steel.
- 7 sets punches and dies. Sizes: 3/32", 1/8", 5/32", 3/16", 7/32", 1/4", and 9/32".



4629
Brass Hammer and Punch Set

- Brass-head hammer and punches are ideal to use where sparks from ferrous metals would be hazardous, or where precision metal parts could be damaged by steel tools.
- Two hammer head weighing 24 and 12 oz.
- Two tapered punches 14" x 5/8", 10" x 5/8".
- One hex tapered punch 8" x 5/8".
- Two drift punches 10" x 3/4", 8" x 1/2".
- Two pin punches 6" x 3/8", 4" x 1/4".



898A
Body and Fender Dent Puller

Often, the biggest time-consuming part of dent removal is the removal and installation of interior panels and upholstery. This tool eliminates those steps. Simply drill a hole at the base of the dent and thread in the tool's self-tapping screw. A few sharp blows of the slide hammer will pull the dent out.

- Puller is 17" long with Pyralin handle grip.
- Replaceable self-tapping screw. Instructions included. 104427-PK5 – Replacement screws (5 pack).



5900A-PLUS
Master Torx Bit Socket Set, 53-piece

Updated 53-piece Master Torx Bit Socket Set plus special 24mm External Torx PLUS Socket (p/n 5932-24) required for Ford Super Duty pick-up beds starting model year 2017. Socket kit includes various sizes of Torx, Torx PLUS, Tamper Resistant Torx, Bit Sockets and External Torx Sockets in 1/4", 3/8" and 1/2" square drive. Stored in a convenient hard plastic clamshell case for protection and organization. Not rated for use with impact tools.

Sizes included:

- Standard Torx: 1/4" Sq Dr T6, T8, T10, T15, T20, T25, T27, T30
- Standard Torx: 3/8" Sq Dr T40, T45, T50, T55
- Standard Torx: 1/2" Sq Dr T60, T70
- External Torx: 1/4" Sq Dr E4, E5, E6, E7, E8
- External Torx: 3/8" Sq Dr E10, E12, E14, E16
- External Torx: 1/2" Sq Dr E18, E20, E22, E24
- Torx PLUS: 1/4" Sq Dr TP8, TP10, TP15, TP20, TP25, TP27, TP30
- Torx PLUS 3/8" Sq Dr TP40, TP45, TP50, TP55
- Torx PLUS 1/2" Sq Dr TP60
- Torx Tamper Resistant 1/4" Sq Dr TT8, TT10, TT15, TT20, TT25, TT27, TT30
- Torx Tamper Resistant 3/8" Sq Dr TT40, TT45, TT50, TT55
- Torx Tamper Resistant 1/2" Sq Dr TT60
- External Torx PLUS 1/2" Sq Dr EP24



4784
Profile Gauge, 10"

This 10" gauge provides an exact copy of a contour or profile needed during bodywork or fabrication. The plastic fingers will not scratch original finish.



**4509
Straight-Blade Hose Cutter**

- Cuts rubber hoses ranging from 1/4" to 1-1/2".
- Simply place hose in tool and squeeze handle to cut.
- Replacement steel cutter blade No. 4509-1 is available.

4509-1 Replacement hose cutter blade.



**4411
Ratcheting Hose & PVC Cutter (Standard)**

- Cuts hose and PVC up to 1-3/8" dia.
- Features metal frame and ergonomic handles for high leverage.
- Compound ratcheting action provides maximum cutting power.
- Will also cut cable and wires.



**4412
Ratcheting Hose & PVC Cutter (Heavy Duty)**

- Cuts hose and PVC up to 1-3/4" dia.
- Features metal frame and rubber padded ergonomic handles for high leverage and comfort.
- Compound ratcheting action provides maximum cutting power.
- Will also cut cable and wires.



**4818
Multi-purpose Scissors**

Will cut hose, wire and cables, wood dowel, PVC, and thin sheet metals in addition to general cutting. The hardened stainless steel blades have an angle ground into one that eliminates slipping when cutting round materials.



Hydraulic Spreaders

- Included as standard equipment with our collision sets, these versatile hydraulic spreader tools are also available individually. Ideal for removing dents and creases, performing straightening jobs, or for use as a clamp. Makes working in tight spots easy.
- Maximum spread is 3-1/4".

9101B

1/2-ton spreader with 1/4" NPT ram half coupler

9102

1/2-ton spreader with 3/8" NPT ram half coupler



4085

Hydraulic Spreader, 1-ton Capacity

This hydraulic spreader is rated at a full 1-ton capacity at 10,000 PSI and that's enough for a wide variety of jobs. Working in tight spots is no problem—it needs only a 9/16" clearance to engage the jaws. With a big 4" spread, it's ready for a variety of applications: straightening work, removing dents and creases from sheet metal, or as a clamp. The device's spring-return jaws are made of high-strength alloy steel. It can be dead-ended at 4" spread under full load. Ideally suited to work with No. 4012 hand pump (not included).



Hydraulic Rams for Collision Repair Sets

These premium quality rams are designed for long, trouble-free service. Backed by a life-time warranty, they are ideal replacements for worn-out, leaky rams. They feature a special piston rod that permits their use with the snap-together components of OTC's collision repair sets, or with most similar competitive products.

4082B

4-ton ram with 5" stroke and special piston rod end designed to fit most collision repair set components.

4083C

10-ton ram with 6-1/8" stroke and special piston rod end designed to fit most collision repair set components.

Specifications

	4082B	4083C
Min. height	10-7/8"	14-5/8"
Max. height	15-7/8"	20-3/4"
Spring return	Yes	Yes
Rod end dia.	.86"	1.3"
Max. operating. Pressure	8,950	9,186
Oil cap. (cu. in.)	4.78	13.69
Oil port	1/4" NPT	1/4" NPT



Hydraulic Rams for Collision Repair Sets

These premium quality rams are designed for long, trouble-free service. Backed by a two-year warranty, they feature a special piston rod that permits their use with the snap-together components of OTC Stinger's new collision repair sets, or with most similar competitive products.

9104B

4-ton ram with 4" stroke and special piston rod end designed to fit most collision repair set components.

9110B

10-ton ram with 6" stroke and special piston rod end designed to fit most collision repair set components.

Specifications

	9104B	9110B
Min. height	10-3/8"	15"
Max. height	14-3/8"	21"
Spring return	Yes	Yes
Rod end dia.	.874"	1.310"
Max. operating. Pressure	8,950	8,950
Oil cap. (cu. in.)	4.97	13.69
Oil port	1/4" NPT	1/4" NPT



1513B – 4-Ton



1515B – 10-Ton

Collision Repair Sets, Stinger Series 4- and 10-Ton

- Very competitively priced, yet high quality sets include single-speed hydraulic hand pump, hose, and ram.
- Components snap together for quick setups to apply pushing, spreading.
- Components include: hydraulic pump, hose, and ram; ram flat base; extension tubes (4); 1/2-ton spreader; tube coupling; ram toe; wedge head; serrated saddle; flex head; plunger toe; 90° wedge head; storage case. The case for the 10-ton set has wheels for mobility.

- 1513B** 4-ton collision repair set. Has single speed hydraulic hand pump and ram with 4" stroke.
- 1515B** 10-ton collision repair set. Has single speed hydraulic hand pump and ram with 6" stroke.



1517B – 4-Ton



1519B – 10-Ton

Collision Repair Sets, OTC Series 4- and 10-Ton

- We've matched our OTC hydraulics with versatile tooling.
- Components snap together, permitting you to apply pushing, spreading.
- Components include: hydraulic pump, hose, and ram; ram flat base; 1/2-ton hydraulic spreader; extension tubes (4); tube coupling; ram toe; wedge head; serrated saddle; flex head; plunger toe; 90° wedge head; storage case. The case for the 10-ton set has wheels for mobility.

- 1517B** 4-ton collision repair set. Has single speed hydraulic hand pump (4000A) and ram (4082B) with 5" stroke.
- 1519B** 10-ton collision repair set. Has two-speed hydraulic hand pump (4012A) and ram (4083C) with 6-1/8" stroke.

5086 Collision Repair Set, 10-Ton

- Exert hydraulic force just where it's needed to lift, spread, bend, or straighten. Handles the high-force jobs you face daily in trailer maintenance or other applications.
- Includes reliable components including 10-ton, 10-1/8" stroke hydraulic ram; air/hydraulic pumping unit; hydraulic hose; four snap-together extension tubes; extension tube coupling; serrated saddle; flat base; 90° wedge head; flex head; storage case.
- All set components are covered by OTC Lifetime Marathon Warranty®.





7176
4 Piece Rolling Head Pry Bar Kit

Here's a set of tools anyone working in the trades will appreciate owning: The 7176, 4 Pc Rolling Head Pry Bar set from OTC! OTC has manufactured some of the very best pry bars in the business and these rolling head designed pry bars are no exception.

Forged, and swaged processing creates the tool, then our special thermal treating process locks in the strength you count on. Won't bend, or break. Backed by our lifetime warranty Includes:

- 7162** 6" Rolling Head Pry Bar
- 7163** 12" Rolling Head Pry Bar
- 7164** 16" Rolling Head Pry Bar
- 7179** 21" Rolling Head Pry Bar
- 5801SGLV-L** SmartTech Work Glove



7179
21-Inch Rolling Head Pry Bar

The OTC 7179 is a 3/4" bar featuring an upset rolling head on one end and an alignment drift on the other.

Made in USA and Lifetime Warranty



7703
Slide Hammer Puller, Ten-Pound

This heavy-duty slide hammer puller gets tough with those really stuck parts. It has all the features of our smaller versions – heat treated, 24" long, and a 5/8"–18 threaded end to adapt to any of OTC's pulling attachments. The difference is the ten-pound hammer that gives you the extra muscle for really stubborn pulling jobs.

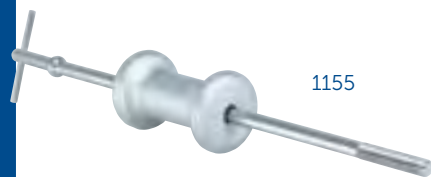

Basic Slide Hammer Units

May be used with an OTC internal pulling attachment (page 127), or with internal or external-internal threaded adapters (page 125).

- 1155** Slide hammer unit is 24" long with a 5 lb. hammer, 5/8"–18 threaded end.
- 1156** Slide hammer unit is 24" long with a 2-1/2 lb. hammer, 5/8"–18 threaded end.



7177
Heavy Duty Extendable Indexing Pry Bar

Designed for heavy duty uses such as positioning/repositioning engines or equipment, aligning heavy steel plates or panels, prying large heavy objects such as decking, grates, covers and general movement of obstructions. The combination extendable reach and pivoting head permits access to many jobs where traditional pry bars may be limited. The prying head is 13/16" wide and can be extended from 34" to 53" using 31 preset positions set in 5/8" increments. Extension and indexing adjustments are done with separate oversized pins allowing length and angle adjustments to be made quickly.

Optimal loading of 1500 lbs. to 2200 lbs. is made possible by the bar's heavy duty 13/16" steel bar and 1-3/8" tubular extension. Knurling has been added at the base of the handle for a strong, secure grip. A must have tool for the next time you need serious leverage for service and maintenance in industry, automotive, construction, agriculture, rigging, or any heavy duty vocational application. Covered by the OTC Limited Lifetime Warranty.



8203L
3-piece Long Handled Pry Bar Set

A set of 3 made-in-the-USA pry bars with comfortable, sturdy rubberized grips. Each bar is drop-forged in Minnesota with a hand-ground chisel end for wedging into tight spaces. Special tempered steel provides extra strength, durability and leverage for tough jobs. A dedicated striking cap provides a big target to drive the pry bar in to help separate components faster. Includes lifetime warranty.

- 8224** 24" handled pry bar
- 8236** 36" handled pry bar
- 8248** 48" handled pry bar



8203S
3-Piece Short Handled Pry Bar Set

A 3-piece Handled Pry Bar Set that includes 8", 12" and 18" lengths for moving or separating components with maximum leverage. Each bar is made from tempered square steel for durability and strength. The dual durometer handle provides a comfortable and secure grip, reducing hand fatigue. A black chrome striking cap will take hammer blows without handle damage, and a polished tip and black oxide finish resists rust and wear during use. Covered by OTC's Lifetime Warranty.

- 8208** 8" handled pry bar
- 8212** 12" handled pry bar
- 8218** 18" handled pry bar



7175
Indexing Pry Bar Set, 3-piece

- Sizes 10", 12" and 15".
- Indexible to 180° for better access.
- 14 locking positions for leverage in multiple applications.
- Knurled handle assures a sure grip.
- Meets or exceeds ANSI specifications for pry bars

- 7172** 10" Indexing Pry Bar
- 7173** 12" Indexing Pry Bar
- 7174** 15" Indexing Pry Bar

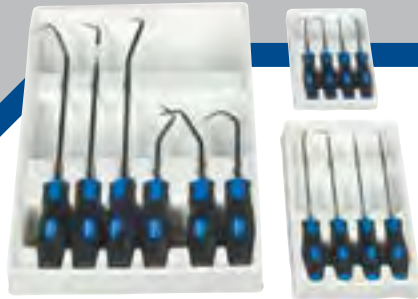

EASILY REMOVE HOSES, CLIPS, WASHERS AND GASKETS

8260M
Short Pick, Long Pick and Hook Set (14-piece)

- Combines 8260, 8262 and 8263 sets.
- Packaged in molded trays which can be placed in tool drawer.



8263
Long Pick and Hook Set (4-piece)

- Consisting of four (4), 6.5", soft-handled picks.
- They are sturdy, with both stainless steel shafts and tips, with assorted tip shapes designed for marking, removing o-rings, accessing snap ring and other assorted applications.
- Ergonomic handle design fits properly in the hand, allowing for easier holding of the tool.
- Multi-use tools to scribe, align pierce, clean or remove o-rings, shaft seals, cv boot and motorcycle fork seals and dust hoods.
- Packaged in a molded tray which can be placed in tool drawer.



4515
Mini Pick and Hook Set – 4-piece

- Sturdy stainless steel points and shafts designed for marking, removing o-rings, accessing snap rings, and performing other tasks. Assorted angle tips allow you to reach awkward locations.
- Knurled shaft design enhances finger control for delicate jobs.

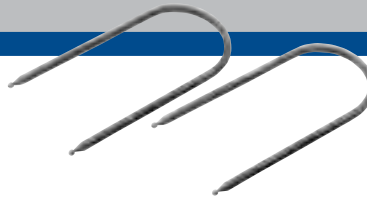

Similar to Ford T87P-19061-A, 415-001

7575
Ford Radio Removal Tool Kit

These dual-purpose tools release the retaining clips of a radio faceplate so you can pull the radio from the instrument panel. For use on 1987 to current Mustang; 1988 and newer Tempo/Topaz; 1989 to current Lincoln Continental; 1990 to current Taurus/Sable, Ranger/Bronco II, Probe, Lincoln Town Car, Mark VII, Crown Victoria/ Grand Marquis, Thunderbird/Cougar, F-series pickups and E-series vans; 1991 to current Explorer; 1995 to 2003 Windstar.

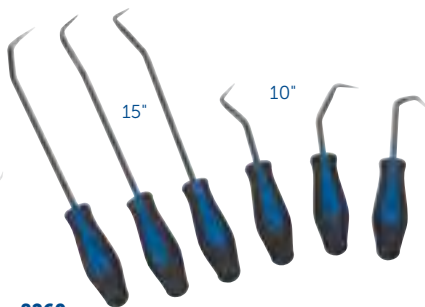

8260
Hose Removal Set, 6-piece

- Consisting of six (6) hose removal tools which consists of three (3) 10", soft-handled tools and three (3) 15", soft-handled tools, each with a hard end-cap.
- They are made of heat-treated, chrome steel with assorted tip shapes.
- Ergonomic handle design fits properly in the hand, allowing for easier holding of the tool.
- Hose removal tools can also be used on upper and lower radiator hoses, clips, washers, gaskets and other items.
- Packaged in a molded tray which can be placed in tool drawer.



4706
Universal Lift Support Clamp (pair)

- Easy-to-use clamps designed for placement on hood/lid strut rods preventing the body component from falling or sagging.
- Great for vehicles & shrouds with weak or dry struts.
- Simply place over strut rod and tighten.
- Small design keeps access to the compartment unobstructed.



4711
Deluxe Radio and Antenna Service Kit

- Eleven-piece kit in molded case.
- Universal antenna wrench.
- Ford radio removal tool.
- Deep sockets to remove and install the tamper-proof radio nuts from many GM, Chrysler, and other aftermarket radios.
- Antenna nut sockets cover most import and domestic antenna nuts.



4712
Euro Radio Removal Tool Kit

- Includes the popular tools needed to remove the radio from the dash on the following European vehicles: BMW, VW, Audi, and Mercedes-Benz.
- Easily removes the radio without damaging the radio or the dash panel.



4715
Deluxe European Radio Tool Set

- 18-piece set of tools used to remove radios on most European vehicles sold in the U.S. and Europe.
 - Quickly and easily removes the radio from the dash without damage to the radio or dash.
- Replacement Parts

- 4715-1** Removal Keys (4 pieces) Audi, Becker, Mercedes-Benz, VW.
- 4715-2** Removal Keys (2 pieces) Becker, Mercedes-Benz, Porsche.
- 4715-3** Removal Keys (2 pieces) VW.
- 4715-4** Removal Keys (2 pieces) Skoda.
- 4715-5** Removal Keys (2 pieces) Becker.
- 4715-6** Pentagon Wrench BMW.
- 4715-7** Bent U-hook (2 pieces) Blaupunkt.
- 4715-8** U-hook (2 pieces) Audi, Blaupunkt, Ford, Grundig, VW.
- 4715-9** Allen Hex Wrench BMW, Opel.

OTC BFH HAMMERS

- Indestructible handle - never needs replacement!
- Ergonomic rubber grip handle reinforced with steel bars resists breaking while absorbing impact and vibration.
- Drop-forged head is induction-hardened for long life, and contains steel locking plates that are specially bonded to ensure the head never becomes loose.



5791ID-412



5792ID-216



5793ID-2414

OTC No.	Head Weight	Handle Length	Total Weight
---------	-------------	---------------	--------------

Club/Hand Drill Hammer, Indestructible Handle

5791ID-312	2.5 lbs.	12"	4 lbs.
5791ID-412	4 lbs.	12"	5.1 lbs.
5791ID-416	4 lbs.	16"	5.5 lbs.

Cross Peen Hammer, Indestructible Handle

5792ID-216	2 lbs.	16"	4.5 lbs.
5792ID-316	3 lbs.	16"	5.4 lbs.

Ball Peen Hammer, Indestructible Handle

5793ID-2414	24 oz.	14"	2.6 lbs.
5793ID-3214	32 oz.	14"	3.0 lbs.



5912

Crimwell™ Angled Crimping Pliers

- Universal crimping design accommodates soft wire – solid or stranded – 10-22 AWG.
- Cutting feature included for quicker preparation.
- 9" (228mm) in length, with protective grips to increase leverage and secure crimp.
- Angled design keeps the connector, the wire, and the crimper "in-line" – improving visibility and access in hard to reach places.
- Designed to not pierce connector insulation and also works on un-insulated connectors.
- Service tech can use as much force as desired to ensure connection and it will not damage connector insulation.
- Easy-to-use: Simply insert the connector into the crimping feature, slip over the connector and squeeze.



4468

Self Adjusting Wire Stripper, 9"

- Strips insulating sheathing from wires ranging from 10 ga. to 22 ga.
- Easy-to-use, just insert wire and squeeze.
- Also cuts and crimps.



5950K

CrimPro™ 4-in-1 Wire Service Set

CrimPro™ 4-in-1 Wire Service Set includes both the OTC 5950S CrimPro™ 4-in-1 Wire Tool and OTC 5950A CrimPro™ 4-in-1 Angled Wire Tool.

5950S

- Compact 7-inch design used 4 ways.
- Gripping nose - to pull, twist, bend, and shape.
- Crimper - crimps 12-20 AWG insulated and non-insulated wire.
- Stripper - strips 12-20 AWG wire.
- Cutter - ability to make cuts below pivot.

5950A

- The angled feature allows access to close quarters and facilitates superior crimps.
- Compact 7-inch design used 4 ways.
- Gripping nose - to pull, twist, bend, and shape.
- Crimper - crimps 12-20 AWG insulated and non-insulated wire.
- Stripper - strips 12-20 AWG wire.
- Cutter - ability to make cuts below pivot.



4467

Automatic Wire Stripper

- Quick removal of insulation on wire AWG 12-20.
- Comes with adjustable depth gauge (8mm to 12mm).
- Sharp v-shaped tooth easily removes insulation without any damage to soft wire strands.
- Cutting tool stored below the stripper.
- Features a space saving locking mechanism for pockets or tool drawer storage.



**5900A-PLUS
Master TORX® Socket Set**

52-piece, professional socket set in a blow-molded case.
Hundreds of applications from front to rear on cars and trucks:

- Seat belt bolts
- Interior and exterior trim screws
- Engine assemblies
- Tail lamp lenses & assemblies
- Bumpers
- Headlight bezels
- Door strikers & latches
- Brake rotor bolts
- GM front-wheel drive front wheel bearings
- Truck box liners

- Styles available: TORX bit sockets, TORX PLUS bits sockets, tamper-resistant TORX bits, and TORX sockets for external bolts.
- Made from superior S2 steel to meet or exceed torque specifications.
- Includes free 5932-24 external TORX plus.

Master Torx Socket Set includes:

TORX® Bit Socket Set T6 to T60 (15-piece)			TORX PLUS® Bit Sockets TP8 to TP60 (12-piece)			TORX® External Socket E4 to E24 (13-piece)			TORX® Tamper-Resistant Bits TT8 to TT60 (12-piece)		
Part No.	Size	Sq. Drive	Part No.	Size	Sq. Drive	Part No.	Size	Sq. Drive	Part No.	Size	Hex Insert
5906	T6	1/4"	5918	TP8	1/4"	5934	E4	1/4"	5919	TT8	1/4"
5908	T8	1/4"	6181	TP10	1/4"	5935	E5	1/4"	5920	TT10	1/4"
6101	T10	1/4"	6182	TP15	1/4"	6151	E6	1/4"	5921	TT15	1/4"
6102	T15	1/4"	6183	TP20	1/4"	6152	E7	1/4"	5922	TT20	1/4"
6103	T20	1/4"	6184	TP25	1/4"	6153	E8	1/4"	5923	TT25	1/4"
6104	T25	1/4"	6185	TP27	1/4"	6154	E10	3/8"	5924	TT27	1/4"
6105	T27	1/4"	6186	TP30	1/4"	6155	E12	3/8"	5925	TT30	1/4"
6106	T30	1/4"	6187	TP40	3/8"	6156	E14	3/8"	5926	TT40	3/8"
6107	T40	3/8"	6188	TP45	3/8"	6157	E16	3/8"	5927	TT45	3/8"
6108	T45	3/8"	6191	TP50	3/8"	5936	E18	1/2"	5928	TT50	3/8"
6109	T47	3/8"	6192	TP55	3/8"	5937	E20	1/2"	5929	TT55	3/8"
6110	T50	3/8"	6193	TP60	1/2"	5938	E22	1/2"	5930	TT60	1/2"
6111	T55	3/8"				5939	E24	1/2"			
6112	T60	1/2"									
6198	T70	1/2"									

**6100
Standard TORX® Socket Set
T10 to T60 (12-piece)**

Set includes one each of the following:

No.	Size	Sq. Drive
6101	T10	1/4"
6102	T15	1/4"
6103	T20	1/4"
6104	T25	1/4"
6105	T27	1/4"
6106	T30	1/4"
6107	T40	3/8"
6108	T45	3/8"
6109	T47	3/8"
6110	T50	3/8"
6111	T55	3/8"
6112	T60	1/2"



**6145
Tamper-Resistant TORX®
Socket Set (7-piece)**

Set includes one each of the following:

No.	Size	Sq. Drive
5920	TT10	1/4"
5921	TT15	1/4"
5922	TT20	1/4"
5923	TT25	1/4"
5924	TT27	1/4"
5925	TT30	1/4"
5926	TT40	3/8"



6160 Fraction Hex Socket Set (7-piece)

Set includes one each of the following:

No.	Size	Sq. Drive
6161	1/8"	3/8"
6162	5/32"	3/8"
6163	3/16"	3/8"
6164	7/32"	3/8"
6165	1/4"	3/8"
6166	5/16"	3/8"
6167	3/8"	3/8"



5905 Tamper-Resistant TORX® Plus Socket Set (11-piece)

Set includes one each of the following:

No.	Size	Sq. Drive
5905-8	8IPR	1/4"
5905-10	10IPR	1/4"
5905-15	15IPR	1/4"
5905-20	20IPR	1/4"
5905-25	25IPR	1/4"
5905-27	27IPR	1/4"
5905-30	30IPR	1/4"
5905-40	40IPR	3/8"
5905-45	45IPR	3/8"
5905-50	50IPR	3/8"
5905-55	55IPR	3/8"



6170 Metric Hex Socket Set (7-piece)

Set includes one each of the following:

No.	Size	Sq. Drive
6171	3 mm	3/8"
6172	4 mm	3/8"
6173	5 mm	3/8"
6174	6 mm	3/8"
6175	7 mm	3/8"
6176	8 mm	3/8"
6177	10 mm	3/8"



5931 External Torx® Plus Socket Set (8-piece)

Set includes one each of the following:

No.	Size	Sq. Drive
5931-6	6EP	3/8"
5931-7	7EP	3/8"
5931-8	8EP	3/8"
5931-10	10EP	3/8"
5931-11	11EP	3/8"
5931-12	12EP	3/8"
5931-14	14EP	3/8"
5931-16	16EP	3/8"



6150 External TORX® Socket Set (7-piece)

Set includes one each of the following:

No.	Size	Sq. Drive
6151	E6 x 25	1/4"
6152	E7 x 25	1/4"
6153	E8 x 25	1/4"
6154	E10 x 32	3/8"
6155	E12 x 32	3/8"
6156	E14 x 32	3/8"
6157	E16 x 32	3/8"



5942 XZN Super Short Socket Bit Set (8-piece)

Set includes one each of the following:

No.	Size	Sq. Drive
5942-4	SP4	1/4"
5942-5	SP5	1/4"
5942-6	SP6	1/4"
5942-8	SP8	1/4"
5942-10	SP10	3/8"
5942-12	SP12	3/8"
5942-14	SP14	3/8"
5942-16	SP16	3/8"



6180 TORX® Plus Socket Set (9-piece)

Set includes one each of the following:

No.	Size	Sq. Drive
6181	TP10	1/4"
6182	TP15	1/4"
6183	TP20	1/4"
6184	TP25	1/4"
6185	TP27	1/4"
6186	TP30	1/4"
6187	TP40	3/8"
6188	TP45	3/8"
6191	TP50	3/8"



5933 MortorQ® Super Bit Set (5-piece)

Set includes one each of the following:

No.	Size	Sq. Drive
5933-0	MTS 0	3/8"
5933-1	MTS 1	3/8"
5933-2	MTS 2	3/8"
5933-3	MTS 3	3/8"
5933-4	MTS 4	3/8"



5940 BMW Head Bolt Socket

- Socket is designed to fit in the cylinder head on M42 and M50 engines to remove and install cylinder head bolts.
- Spring loaded detent ball holds bolt in place.
- Works with 1/2 inch ratchet, breaker bar, or torque wrench. Socket size is E12 for external TORX® bolts.

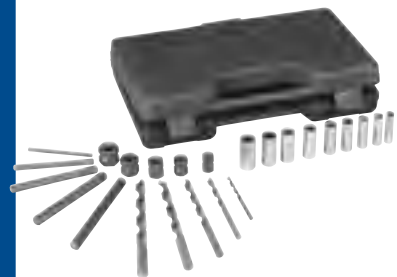

4651 Screw Extractor Set

- Removes broken studs and bolts.
- Includes ten guide bushings, five drill bits and five screw extractors with extractor nuts.
- Drill bits are left handed to help removal.

Similar to Toyota No. 09043-50080



6022 Toyota Head Bolt Socket

- Specially designed socket is needed to tighten or loosen head bolts on Toyota Paseo vehicles with 3S-GE and 3S-FE engines.
- 8 mm socket features a 12-point, 1/2" drive socket.



**5943
9-Piece Power Driver Socket Extensions**

The new 5943, 9 piece Power Driver Socket Extension set from OTC adds versatility to your existing power tools and socket sets. Each extension uses a 1/4" hex shank for adjustable chuck drills with 1/4", 3/8" or 1/2" square drive on the other end for sockets. 3 square drive sizes - 1/4", 3/8" and 1/2" and 3 lengths for each - 2", 6" and 12". Now use your sockets with your cordless power tools for short, medium and long reach applications. The 5943 is a great choice for running up multiple bolts like oil and transmission pans or rear ends instead of ratcheting each one by hand. Save your time for proper torquing instead of hand turning your bolts. Limited lifetime warranty.

- 5943-1** Three 1/2" square drive socket extensions in 2", 6" and 12" lengths
- 5943-2** Three 3/8" square drive socket extensions in 2", 6" and 12" lengths
- 5943-3** Three 1/4" square drive socket extensions in 2", 6" and 12" lengths

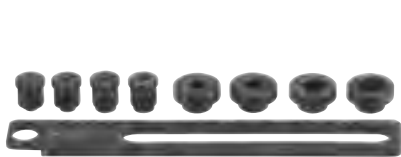

**6982DGS
Drilling Guide System**

- Drill perfectly centered holes in broken studs.
- Anchor rail guide on any open hole within reach of broken stud - 6 inch reach.
- 4 bushings for common stud sizes - 6mm, 8mm, 10mm, and 12mm.
- 4 drilling guides for progressive drilling - 1/16", 3/32", 1/8" and 5/32".
- Conveniently stores in vinyl pouch - includes instructions.
- Made in USA with a Lifetime Warranty.

- 6982DGS-1** 4-Pc Bushing Set
- 6982DGS-2** 4-Pc Guide Set
- 6982DGS-3** Replacement Rail



**6982DEX
3 Pc Double Edge Screw Extractors**

- For unscrewing broken bolts and screws without damaging threads.
- Can be turned in clockwise or counter clockwise direction for right and left handed threads.
- Drive extractor into drill hole for secure fit.
- Hex shank design works with standard hex sockets eliminating rounded corners.
- Industrial Quality - Made from High Strength Steel - Tapered Flute design.

- 6982DEX-1**
No. 1 Dual Edge Screw Extractor (#10 - 1/4")
- 6982DEX-2**
No. 2 Dual Edge Screw Extractor (5/16" - 3/8")
- 6982DEX-3**
No. 3 Dual Edge Screw Extractor (7/16" - 1/2")



**6982ACP
Automatic Center Punch**

- Accurately marks your drill point every time.
- Creates deep center mark to prevent drill bit from wandering.
- Flared top fits comfortably in palm of hand.
- Allows free hand to place marking tip exactly where you want it.
- Press tool until spring releases causing tip to mark your drilling point.





Impact Drivers

- Loosens hard-to-turn screws, bolts or nuts.
- Handle design prevents possibility of hitting hand with hammer when striking impact driver.
- Bit holder has 3/8" drive (No. 4608), 1/2" (No. 4607) drive, and 5/16" hex for Phillips and flat screwdriver bits.
- Includes eight screwdriver bits:
No. 2 Phillips bit, 1-3/8" long with 5/16" hex
No. 2 Phillips bit, 3-1/8" long with 5/16" hex
No. 3 Phillips bit, 1-3/8" long with 5/16" hex
No. 3 Phillips bit, 3-1/8" long with 5/16" hex
5/16" wide x 1-3/8" long with 5/16" hex slotted bit
5/16" wide x 3-1/8" long with 5/16" hex slotted bit
3/8" wide x 1-3/8" long with 5/16" hex slotted bit
3/8" wide x 3-1/8" long with 5/16" hex slotted bit

- 4607** 1/2" Impact Driver
- 4608** 3/8" Impact Driver



**4576
Universal C-Frame Nut Splitter**

- Forged and heat-treated frame with offset handle works where ordinary nut splitters may fail. Smooth action cracks nuts without damaging bolt threads.
- Chisel rotates to line up parallel to bolt. Splits non-heat-treated nuts of 7/16" (11 mm) through 3/4" (19 mm) diameter. Tool is 6-3/4" in length.



**7402
Universal Outside Thread Chaser**

- Quickly restore threads to near new condition without expensive thread cutting equipment.
- Replaceable V-Pads and dies. Use for 1-1/4" to 5" O.D.
- Includes Standard Die Set 216884.
- Metric size dies available 202817, must be purchased separately.

- 216884** **Standard die set.** Includes 6 dies, threads per inch - 4, 5, 6, 7, 7-1/2, 8, 9, 10, 11, 11-1/2, 12, 14, 16, 18, 20, and 24.
- 202817** **Metric die set.** Includes three dies: 1 mm- 1.25 mm-1.5 mm-1.75 mm, 2 mm-2.5 mm-3.0 mm-3.5 mm; 4 mm pitch dies.
- 206803** **V-pad.**



**4614
Side Terminal Battery Wrench**

- Designed for use on GM side-terminal batteries, or any 5/16" hex head battery bolt.
- 5/16", 6 point, box end, 5-1/2" long, ratcheting wrench; insulated handle.



**4615
Long-Side Terminal Battery Wrench**

- Designed for use on GM side-terminal batteries, or any 5/16" hex head battery bolt.
- Long handle allows access to hard-to-reach battery terminal bolts.
- 5/16", 6 point, box end, 10" long, ratcheting wrench; insulated handle.



**4616
Battery Terminal Wrench - 10mm**

- Designed for use on 10 mm battery terminal bolts found on many import and domestic vehicles.
- 10 mm, 12 pt., box-end ratcheting wrench; 5-1/2" long with insulated handle.



**4791
Spanner Wrench, 3/4" - 2"**

This chrome vanadium hardened steel wrench features a 5" handle and slim strong hook to access slotted retaining rings in hard to reach areas.



**4792
Spanner Wrench, 2" - 4 3/4"**

This chrome vanadium hardened steel wrench features a 9" handle and slim strong hook to access slotted retaining rings in hard to reach areas.



**885
Adjustable Hook Spanner Wrench**

- Here's a tool that's needed wherever turret adjusting nuts or packing gland nuts are used.
- Capacity is 1-1/2" to 4".
- Handle is 24" long, 11/16" diameter.



7307

Fed. Spec.: GGG-W-665b



7308

Adjustable Hook Spanner Wrenches

These pieces will replace many fixed-size wrenches needed to service industrial tractors and other equipment. Their drop-forged jaws adjust to 11 positions for a capacity of 4-3/4" to 12-3/4" O.D.

- Handle is 24" long and 1" in diameter.

7307 Spanner wrench with one 3/8" thick jaw.

7308 Spanner wrench with two interchangeable jaws: one 3/8" thick, one 3/4" thick.



Fed. Spec.: GGG-W-665b

**7309
Heavy-Duty Adjustable Hook Spanner Wrench**

Some jobs require beefier tools. Here's a wrench to fill that need. It's drop-forged and features extra heavy construction and a 3/4" thick, 11-position hook jaw that's capable of gripping fasteners from 4-3/4" to 12-3/4" O.D.

- Handle is 25-3/4" long and 15/16" in diameter.



**6719-1
Locking Pliers**
10" straight locking pliers



Accutorq™ Klikker Torque Wrenches

These precision torque wrenches make a loud click when you've reached the torque setting. They feature ratcheting heads, all-metal construction, permanently roll-marked scales, and soft-grip rubber handles that enable you to firmly grasp the wrench for right- or left-hand torquing.

- Includes molded plastic case.
- One-year warranty.

Tool No.	Torque Range	Graduations	Square Drive	Length
7375	100-1000 in.-lb (11-113 N•m)	10 in.-lb	3/8"	15-1/8"
7377	10-150 ft.-lb (14-203 N•m)	2 ft.-lb	1/2"	17-3/4"
7378	25-250 ft.-lb (34-339 N•m)	2 ft.-lb	1/2"	19-3/8"
7379	100-600 ft.-lb (136-813 N•m)	10 ft.-lb	3/4"	42-1/4"



**7367
Torque Multiplier, 1100 ft-lb**

- Drive Input; 1/2", 365 lb-ft Max
- Drive Output; 3/4", 1100 lb-ft Max
- Head Width; 2.9", 3.3:1 Ratio
- Reaction Bar; 13-3/4"
- Includes reaction foot.
- Note; frictional gear loss = 6%



**7368
Torque Multiplier, 2200 ft-lb**

- Drive Input; 3/4", 730 lb-ft Max
- Drive Output; 1", 2200 lb-ft Max
- Head Width; 3.6", 3.3:1 Ratio
- Reaction Bar; 15-5/8"
- Includes reaction foot.
- Note; frictional gear loss = 6%

**4554
Torque Angle Gauge**

Required when servicing many late model engines that use torque-to-yield fasteners. Measures angle of rotation after pre-torque in torque-angle applications.

- The 360° scale is marked in 2° increments and intervals of 10° and 30°; easily zeroed for next application by turning the tool housing.
- Has 1/2" male and female square drives.



**5776
Preset Torque Wrench Set**

These color coded click torque wrenches are pre-set to the most common lug nut torque settings, making them perfect for tire shops. Highly durable design can hold up to the toughest tire shop demands.

- No need for adjustments
 - Durable satin finish
 - 1/2" Drive, 36 tooth
 - Quick release ratchet head
 - Perfect for Wheel / Tire shop
 - Accuracy better than ±3% CW
- Sold Individually:

**5776-1
Preset Torque Wrench, 1/2" 65 lb-ft**

**5776-2
Preset Torque Wrench, 1/2" 80 lb-ft**

**5776-3
Preset Torque Wrench, 1/2" 100 lb-ft**

**5776-4
Preset Torque Wrench, 1/2" 120 lb-ft**

**5776-5
Preset Torque Wrench, 1/2" 140 lb-ft**



**7380-E150
Digital Torque Wrench**

- Displays torque in real time and at peak when torque is released.
- Torque value accuracy is ±1% clockwise (CW) and counterclockwise (CCW) from 10%-100% of full scale.
- Can be used to measure bearing preload torque values.
- Display starts at 1% to 250% of full scale; has a 5-digit, alpha-numeric LCD, and indicator icons for functions, units and battery.
- Indicators include green, yellow and red LED light, an audible buzzer, and vibration.
- 1/4" Drive, 36 tooth ratchet head. Range 1.5 - 150 In Lb.

FASTENER SERVICE AUTOMOTIVE SPECIALTY TOOLS

Giant Adjustable Wrenches

The really big jobs call for really big tools. These wrenches will handle 42 bolt sizes from 1-3/8" to 4-3/4". Together, both wrenches weigh just 41 lbs., but can replace over 1,000 lbs. of fixed-size wrenches.

7640 Giant adjustable wrench. Rated to withstand 2,000 ft. lbs. of torque.

7641 Giant adjustable wrench. Rated to withstand 5,000 ft. lbs. of torque.



Tool No.	Nut / Bolt Size	Increments of Jaw Adjustment	Lgth..	Head Thickness	Wt. (lbs.)
7640	1-3/8" to 2-7/8"	1/8"	24"	7/8"	10.6
7641	2-3/4" to 4-3/4"	1/8"	36"	1-1/8"	30.3

6969 Ratcheting Chain Wrench – 24"

- Ratcheting action makes it possible to re-grip without removing wrench.
- Handles parts of most any shape... round, square, hexagon, or octagon.
- Handle is 24" long; chain grips objects ranging from 3" to 6-1/2" O.D.

516942 Replacement chain

6968 Ratcheting Chain Wrench – 12"

- Works on many different-shaped objects, such as square, round, hexagon, oval, etc.
- Handle is 12" long; chain grips objects ranging from 1/2" to 4-1/2" O.D.

516941 Replacement chain



SmartTech™ Technician Gloves

- Works with touchscreen technology.
- Washable synthetic leather palm with padding ensures comfort and a secure grip.
- Polyester and Lycra material around fingers offer a durable lightweight cover that stretches for a great fit.
- PVC cushions help protect knuckles from injury due to slippage.
- Comfortable polyester back panels include webbing for improved ventilation.

5801SGLV-L Large

5801SGLV-XL Extra large

7400 Ratcheting Chain Wrench

This multi-purpose tool will grip parts of nearly any shape. It features a ratcheting head design that lets you turn in either direction without removing wrench from the work.

- 13" handle with capacity from 1/2" to 4-3/4" O.D.

209199 Replacement chain



7206 Multipurpose Strap Wrench

You'll find many uses for this heavy-duty strap wrench. The 53" long nylon strap won't mar precision surfaces of shafts, pulleys, or other components. Useful on engine, transmission, and drive pulleys up to 16 inches. Special head design self-tightens the strap as force is applied to the lightweight, 12" long handle.

305085 Replacement chain



4804 Heavy Duty Pulley Holder

This strap style universal wrench features a 9" drop forged handle and 23" leather strap for excellent grip on diameters up to 7". The milled foot increases grip on the strap and pulley as handle force is increased.



7401 Ratcheting Chain Wrench

This multi-purpose tool will grip parts of nearly any shape. It features a ratcheting head design that lets you turn in either direction without removing wrench from the work.

- 19" handle with capacity from 3" to 6-3/4" O.D.

209200 Replacement chain



4780
Personal Tool Pack

Includes 1/4" drive ratchet, 2" extension, 16 drive bits, and Universal Spline sockets fit both SAE 3/16" - 9/16" and metric 5mm - 14mm nuts and bolts in a variety of styles; 6 pt., 12 pt., torx, square, spline, etc. All tools included in a travel pouch.



4781
Super Stubby Screwdriver Set

These screwdrivers are perfect for those limited access fasteners typically found on carburetors or in electrical compartments and many other areas.

- 2 Phillips and 2 straight screwdrivers included in set.



4490
Magnetic Parts Tray

- Rectangular, stainless steel tray is 9-1/2" x 5-1/2" and 1-1/4" deep. Holds tools and small metal parts, so they don't get lost or misplaced during repair work.
- Two heavy-duty magnets on bottom of tray, with non-marring contact pads, securely hold tray to metal objects such as a tool box, air cleaner cover, frame rail, fender, etc.

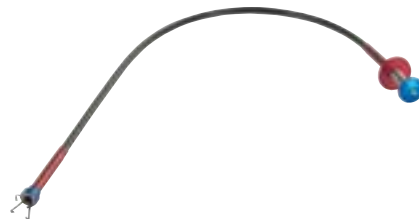

4783
Flexible Magnetic/Claw Pick Up Tool

The 25" flexible spring shaft allows the tool to reach difficult areas and pick up objects either magnetically or with the use of the retractable claw.



4794
Safety Wire Drill Guide Set, SAE & Metric Set

Here is the perfect way to drill those nuts and bolts for use with safety wire without breaking the drill bit. These guide, align, and support the hex head or the bolt threads. The hex fixture fits nuts and bolt heads up to 15/16" (24mm). The SAE fixture bar is threaded for 1/4"-20, 5/16"-18, 5/16"-24, 3/8"-18, 3/8"-24, 7/16"-14 bolts, and the Metric fixture bar covers M6x1.0mm, M8x1.0, M8x1.25mm, M10x1.25mm, M10x1.5mm, M12x1.5mm sizes.



4779
Front Fork & Shock Vice

This vice is designed to hold up to 4" diameter round or oddly shaped components such as forks, shocks, pistons, rods, etc. The V shaped jaws are covered with thick rubber pads to ensure a firm grip without leaving a mark. Comes complete with a table/vice mounting bracket that allows adjustment to any position.

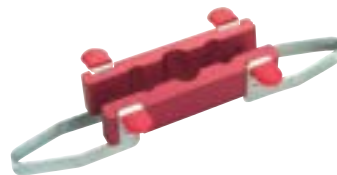

4786
Aluminum Vice Inserts

Essential for every workbench vice. Aluminum jaws have reliefs for 5/16, 3/8, & 9/16 (7mm, 10mm, & 15mm) diameter shafts. Excellent for holding steel shafts without scratching or damage such as shocks, crankshafts, or any threaded bolts and shafts.



4650
Mirror and Magnet Set

- Handles telescope from 6-1/2" to 25". Swivel heads allow access to tight areas.
- Large, rectangular swivel mirror is 2" x 3-1/2", and is attached to one telescoping handle; small mirror is 1-1/4" in diameter, and is interchangeable with magnets on the other handle.
- Magnets can lift up to 8 lbs.



4801
Universal Clutch Holder

Holder arms designed to fit into the external teeth of a clutch hub, but can also be used on gears and sprockets. Opens to handle a 5" OD hub.



4795
Safety Wire Twist Pliers

These versatile 8" pliers will reliably twist safety wire rapidly and consistently. The right hand twist mechanism features an automatic spring return. The forged alloy steel construction features tapered jaws for confined areas and mated cutters to cut safety wire. For use on safety wire applications found on vehicles, machinery, and aircraft.

RETAINING RING PLIERS

Here are a variety of retaining ring pliers, available individually or in sets, to handle many applications.

7053K

Internal/external retaining ring pliers kit. Includes four 90° tips (.038" diameter), four 45° tips (.047" diameter), and eight straight tips (.047" and .070" diameter).

15702

Replacement tip kit. Contains 4 sets, 4 tips per set.



7123K

Convertible retaining ring pliers kit. For internal or external rings. Contains one No. 1120 (.038" diameter) and one No. 1340 (.070" diameter) straight tip pliers.



7125K

Convertible retaining ring pliers kit. For internal or external rings. Contains one No. 1125 (.038" diameter) and one No. 1345 (.070" diameter) 45° pliers.



7300

Internal, straight tip retaining ring pliers. 16" long.

7301

External, straight tip retaining ring pliers. 16" long.



7300 Internal tip

7301 External tip

Replacement tips (pairs):

- 209201** For pliers Nos. 7300 and 7301.
- 222029** 45° for pliers Nos. 7300 and 7301.
- 222030** 90° for pliers Nos. 7300 and 7301.



209201

222029

222030

INTERNAL		CONVERTIBLE		EXTERNAL	
No. 0100	No. 7300	No. 1120	No. 1340	No. 0200	No. 7301
No. 0300		No. 1125	No. 1345	No. 0400	
No. 0500				No. 0600	

How to select the correct pliers:

1. If ring number is known, locate ring number in chart —pliers are listed in right-hand column.
2. Or, measure diameter of shaft bore and locate size in chart—pliers are in right-hand column.

Ring Series No.	Size Range (Ring Size No.)	Bore of Shaft Dia. Range ("Inch" equiv.)	Pliers No.	
	12 to 87	1/8" to 7/8"	0200	
	12,15,25 to 66	1/8" to 21/32"	1120, 1125	
	25 to 143	1/4" to 1-7/16"	7053K, 7123K, or 7125K	
	93 to 143	15/16" to 1-7/16"	1340, 1345, or 0400	
	5100 5101 5102 555	31 to 75 150 to 350 75	5/16" to 3/4" 1-1/2" to 3-1/2" 3/4"	0600
	354 to 650	3-35/64" to 6-1/2"	7301	
	50 to 100	1/2" to 1"	0200	
	50 to 78	1/2" to 25/32"	1120	
	50 to 200	1/2" to 2"	7053K, 7123K, or 7125K	
	5108	106 to 200 215 to 334 350 to 400	1-1/16" to 2" 2-1/8" to 3-11/32" 3-1/2" to 4"	1340, 1345, or 0400 0600 7301
	37 to 102	3/8" to 1-1/32"	0100	
	37 to 56	3/8" to 9/16"	1120, 1125	
	37 to 200	3/8" to 1-3/4"	7053K, 7123K, or 7125K	
	N5000 N5001 N5002	106 to 175 181 to 300	1-1/16" to 1-3/4" 1-13/16" to 3-1/2"	1340, 0300 0500
		306 to 625	3-1/16" to 6-1/4"	7300
	75 to 137	3/4" to 1-3/8"	0100	
	75 to 100	3/4" to 1"	1120, 1125	
	75 to 200	3/4" to 2"	7053K, 7123K, or 7125K	
	5008	143 to 200 206 to 300 315 to 400	1-7/16" to 2" 2-1/16" to 3" 3-5/32" to 4"	1340, 1345, or 0300 0500 7300

0100

.038" tip diameter straight for removing internal rings.



0200

.038" tip diameter straight for removing external rings.



0300

.070" tip diameter straight for removing internal rings.



0400

.070" tip diameter straight for removing external rings.



0500

.115" tip diameter straight for removing internal rings.



0600

.090" tip diameter straight for removing external rings.



7295

Retaining Ring Pliers

The "squeeze-lock" ratchet action of this tool locks retaining rings in position, making removal and installation easy. It features cushioned handles to ensure a secure grip.

- Will handle rings 3/16" thick and up to 4" in diameter.
- Pliers is 12" long.



211051

Two replacement tips.

7313

Retaining Ring Pliers

This tool removes the external retaining rings used in transmissions, differentials and other automotive components.

- Maximum spread is 1-1/16" and 7-3/4" long.

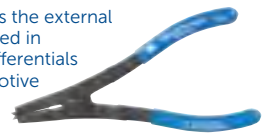

714

Horseshoe Lock Ring Pliers

This ruggedly built pliers is designed to spread and remove horseshoe lock rings used on hydraulic brakes, differentials, transmissions, and CV joints.

- Handles are 8" long.



7412K

Retaining Ring Pliers Set

This set includes 12 of our most popular retaining ring pliers, in sizes for automotive applications. Tips include straight, 45°, and 90° angles in four different sizes (.038, .047, .070, and .090" diameter).

- Includes a sturdy plastic organizer box.



4512

Snap Ring Pliers Set – Internal/External

- For internal or external snap rings; thumbscrew permits quick conversion.
- Made of heavy-gauge tempered steel.
- Includes two stainless steel handled picks.
- Contained in a blow-molded plastic storage case.

4513

Heavy-Duty Snap Ring Pliers Set (2 piece)

- Heat treated steel "circlip" pliers for large equipment repair.
- Replaceable tips and spring ratchet locking mechanism to securely hold against snap ring tension.
- Internal pliers' capacity 3-1/16" to 6-1/4" (78 mm to 159 mm) snap rings.
- External pliers' capacity 3-1/2" to 6-1/2" (89 mm to 165 mm) snap rings.
- Blow-molded storage case includes extra sets of replaceable tips.
- Overall length 16"; handle length 12-1/2".

No. 7412K Includes:

Tool No.	Description
1120	.038" dia., straight
1125	.038" dia., 45°
1131	.038" dia., 90°
1320	.047" dia., straight
1325	.047" dia., 45°
1329	.047" dia., 90°
1340	.070" dia., straight
1345	.070" dia., 45°
1349	.070" dia., 90°
1560	.090" dia., straight
1565	.090" dia., 45°
1569	.090" dia., 90°

All items can be purchased separately.

No. 4512 includes:

Tool No.	Description
4512-1	.090" tip, straight pliers
4512-2	.090" tip, 90° pliers
4512-3	.070" tip, straight pliers
4512-4	.070" tip, 90° pliers
4512-5	.047" tip, straight pliers
4512-6	.047" tip, 90° pliers
4512-7	.038" tip, straight pliers
4512-8	.038" tip, 90° pliers
4512-9	straight tip pick
4512-10	90° tip pick

All items can be purchased separately.



No. 4513 includes:

Tool No.	Description
4513-1	Internal snap ring pliers
4513-2	External snap ring pliers
4513-3	(2) .12" (3 mm) straight tip

Tool No.	Description
4513-4	(2) .12" (3 mm) 45° tips
4513-5	(2) .12" (3 mm) 90° tips
4513-6	4 tip retaining screws

7410

Retaining Ring Pliers with replaceable tips

An ideal tool for any transmission shop, this 13" long pliers with a maximum spread of 2.5" features replaceable tips and a spring-return handle.

214903

Set of replacement tips.

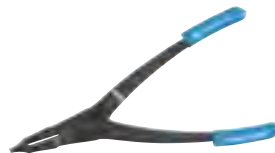

4514

Mini Snap Ring Pliers Set, 4-piece

Service S-ring and R-ring clips, internal or external, straight or angled. Ruggedly built of heat-treated chrome molybdenum steel.

- Set includes two internal snap ring pliers (one straight, one 45°) and two external snap ring pliers (one straight, one 45°).
- All pliers have .038" (1.0mm) diameter tips.
- Overall length 3"; handle length 2".



PLIERS & CUTTERS AUTOMOTIVE SPECIALTY TOOLS



4509 Straight-Blade Hose Cutter

- Cuts rubber hoses ranging from 1/4" to 1-1/2".
- Simply place hose in tool and squeeze handle to cut.

4509-1 Replacement hose cutter blade.



4411 Ratcheting Hose & PVC Cutter (Standard)

- Cuts hose and PVC up to 1-3/8" dia.
- Features metal frame and ergonomic handles for high leverage.
- Compound ratcheting action provides maximum cutting power.
- Will also cut cable and wires.



4412 Ratcheting Hose & PVC Cutter (Heavy Duty)

- Cuts hose and PVC up to 1-3/4" dia.
- Features metal frame and rubber padded ergonomic handles for high leverage and comfort.
- Compound ratcheting action provides maximum cutting power.
- Will also cut cable and wires.



4818 Multi-purpose Scissors

Will cut hose, wire and cables, wood dowel, PVC, and thin sheet metals in addition to general cutting. The hardened stainless steel blades have an angle ground into one that eliminates slipping when cutting round materials.



5912 Crimpwell™ Angled Crimping Pliers

- Universal crimping design accommodates soft wire – solid or stranded – 10-22 AWG.
- Cutting feature included for quicker preparation.
- 9" (228mm) in length, with protective grips to increase leverage and secure crimp.
- Angled design keeps the connector, the wire, and the crimper "in-line" –improving visibility and access in hard to reach places.
- Designed to not pierce connector insulation and also works on un-insulated connectors.
- Service tech can use as much force as desired to ensure connection and it will not damage connector insulation.
- Easy-to-use: Simply insert the connector into the crimping feature, slip over the connector and squeeze.

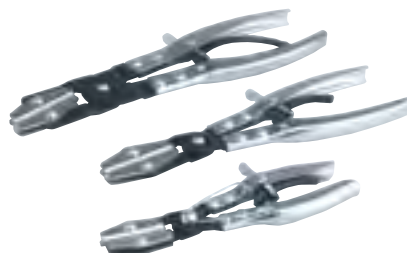

4510 Hose Pinch Off Pliers Set, 3 Piece

- Shuts off flow through vacuum lines, fuel lines, coolant lines, etc.
- Cocking ratchet mechanism holds pivoting jaws tightly in place. Heavy-duty swivel jaws pivot to assure parallel pinching.



4802 Universal Pulley Holder Locking Pliers

This adjustable locking pliers can be used to hold pulleys, clutch hubs, flywheels, gears, and sprockets with internal or external teeth up to a 4" diameter. Can also be used on applications with slots or holes with the 5/16" pins.



4613 Battery Pliers

- Serrated jaws firmly grip the battery terminal nut or bolt.
- Offset handles allow access in hard-to-reach areas.
- Works on top-post and side-post battery terminals.



4493 Angle-Tip Relay Pliers

- Designed to remove and install relays, which are usually located in confined, hard-to-reach areas.
- Specially coated tips offer a solid grip on the relay.

4477 3/8" Cable Cutters,

Perfect choice for cutting heavier copper and aluminum cables.

- This tool is especially valuable for battery service where replacing a terminal is required.
- Clean cut with minimal mashing of wire strands.



Handled Pry Bars

Heavy-duty pry bar made of tempered square steel that you can hit without damaging the handle.

- Black chrome striking cap allows hitting the bar without damage to the handle.
- Ergonomic handle – dual durometer composite handle for user comfort; reduces hand fatigue.
- Polished tip with black oxide finish.
- Long-life finish resists rust and wear during use.
- OTC Lifetime Warranty.



8203L
3-piece Long Handled Pry Bar Set

- 8224** 24" handled pry bar
- 8236** 36" handled pry bar
- 8248** 48" handled pry bar

8203S
3-Piece Short Handled Pry Bar Set

- 8208** 8" handled pry bar
- 8212** 12" handled pry bar
- 8218** 18" handled pry bar



Jimmy Bars

We've forged these bars from chrome alloy steel, then heat-treated them to resist bending and breaking.

- 7166** 5/8" diameter, 18" long
- 7167** 3/4" diameter, 24" long
- 7168** 7/8" diameter, 30" long
- 7420** 7/8" diameter, 46" long

7177
Heavy Duty Extendable Indexing Pry Bar

- The prying head is 13/16" wide and can be extended from 34" to 53" using 31 preset positions set in 5/8" increments.
- Extension and indexing adjustments are done with separate oversized pins allowing length and angle adjustments to be made quickly.
- Optimal loading of 1500 lbs. to 2200 lbs. is made possible by the bar's heavy duty 13/16" steel bar and 1-3/8" tubular extension. Knurling has been added at the base of the handle for a strong, secure grip.
- OTC Lifetime Warranty.



7176
4 PC Rolling Head Pry Bar Kit

- Set includes 4 OTC Rolling Head Pry Bars (6", 12", 16" and 21" lengths)
- Upset head design provides optimal leverage
- Tapered end designed for hole alignment
- Proprietary thermal treatment provides superior strength and durability
- Chrome finish resists corrosion
- Comes with free pair of OTC SmartTech Gloves (Large)



Rolling Head Pry Bars

You'll have a lot of leverage using one of these rolling head pry bars. The long, tapered body will also serve as an aligning drift.

- 7162** 6" Rolling Head Pry Bar
- 7163** 12" Rolling Head Pry Bar
- 7164** 16" Rolling Head Pry Bar
- 7165** 18" Rolling Head Pry Bar (not shown)
- 7179** 21" Rolling Head Pry Bar



7175
Indexing Pry Bar Set, 3-piece

- Sizes 10", 12" and 15".
- Indexible to 180° for better access.
- 14 locking positions for leverage in multiple applications.
- Knurled handle assures a sure grip.
- Meets or exceeds ANSI specifications for pry bars

- 7172** 10" Indexing Pry Bar
- 7173** 12" Indexing Pry Bar
- 7174** 15" Indexing Pry Bar

7171
Pry Pac

Three pry bars in one economical pack. You get 12" and 18" rolling head pry bars and a 24" jimmy bar.

- Heat-treated chrome alloy steel.



7687A
Pry Bar Head

- Turns any 3/8" drive ratchet or breaker bar into a rolling head pry bar.
- Gives you the versatility of a pry bar without the storage problems.



9900A
Persuader Pry Bar Merchandiser

- Includes 10 Chisel and Alignment Jimmy Bars:
- 30" in length; 7/8" diameter.
- Forged and chromed alloy steel.
- Designed and heat-treated to resist bending and breaking.
- Made in USA.
- Lifetime warranty.

The sturdy cardboard merchandiser is 52" high, 18" wide and 12" deep, specifically designed for the Jimmy Bars, is free with purchase.



9901A
MAJOR Persuaders Pry Bar Merchandiser

- Includes two 30" 7168 Jimmy Bars.
- Includes two 46" 7420 Jimmy Bars.
- Includes one 54" 7421 Jimmy Bar, covering almost any medium and heavy-duty application.

The sturdy cardboard merchandiser is 64" high, 16" wide and 18" deep.





EASILY REMOVE HOSES, CLIPS, WASHERS AND GASKETS

8260M

Short Pick, Long Pick and Hook Set, 14-piece

- Combines 8260, 8262 and 8263 sets.
- Packaged in molded trays which can be placed in tool drawer.



8262

Short Pick and Hook Set, 4-piece

- Consisting of four (4), 6.5", soft-handled picks.
- They are sturdy, with both stainless steel shafts and tips, with assorted tip shapes designed for marking, removing o-rings, accessing snap rings and other assorted applications.
- Ergonomic handle design fits properly in the hand, allowing for easier holding of the tool.
- Multi-use tools to scribe, align pierce, clean or remove o-rings, shaft seals, cv boot and motorcycle fork seals and dust hoods.
- Packaged in a molded tray which can be placed in tool drawer.



4508

Professional Style Seal Puller

- Designed to remove oil and grease seals when servicing cars, SUVs, and light trucks without damaging the housing or bearing.
- Hook tips in two sizes and professional handle design allows removal of hard-to-get-at seals by getting under them.
- The tool is 12" long and the hook tip is double-secured (versus competitors' designs), for durability.
- An extra blade is included, and additional replacements (No. 4508-1) may be ordered.

4508-1 Replacement blade for 4508



8263

Long Pick and Hook Set, 4-piece

- Consisting of four (4), 6.5", soft-handled picks.
- They are sturdy, with both stainless steel shafts and tips, with assorted tip shapes designed for marking, removing o-rings, accessing snap ring sand other assorted applications.
- Ergonomic handle design fits properly in the hand, allowing for easier holding of the tool.
- Multi-use tools to scribe, align pierce, clean or remove o-rings, shaft seals, cv boot and motorcycle fork seals and dust hoods.
- Packaged in a molded tray which can be placed in tool drawer.

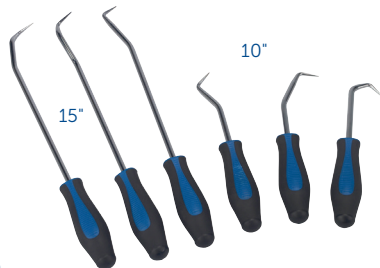

8260

Hose Removal Set, 6-piece

- Consisting of six (6) hose removal tools which consists of three (3) 10", soft-handled tools and three (3) 15", soft-handled tools, each with a hard end-cap.
- They are made of heat-treated, chrome steel with assorted tip shapes.
- Ergonomic handle design fits properly in the hand, allowing for easier holding of the tool.
- Hose removal tools can also be used on upper and lower radiator hoses, clips, washers, gaskets and other items.
- Packaged in a molded tray which can be placed in tool drawer.

7103

O-Ring / Oil Seal Pick Set

Fishing a stubborn o-ring or oil seal out of its seat is easy if you have this pair of picks in your toolbox.

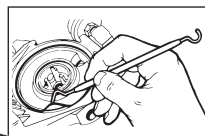

7312

O-Ring / Oil Seal Pick

Here's an extremely handy tool that makes quick work of oil seal and o-ring removal and installation.

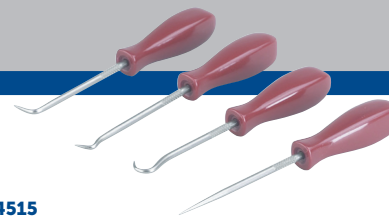

4515

Mini Pick and Hook Set, 4-piece

- Sturdy stainless steel points and shafts designed for marking, removing o-rings, accessing snap rings, and performing other tasks. Assorted angle tips allow you to reach awkward locations.
- Knurled shaft design enhances finger control for delicate jobs.



4658

Windshield Spray Nozzle Needle

- Makes quick work of clearing obstructions from the windshield washer spray nozzle.
- Easily pierces corrosion or remove blockage.
- The barrel is knurled for grip and control.
- Threaded end caps keep the needle points covered when not in use. The pocket clip keeps the tool handy.



4600

Punch and Chisel Set, 16 piece

- Durable set of heat-treated chrome vanadium steel punches & chisels. Storage tray included. Contents of set, Also Available separately.

No.	Part No.	Description
1	4600-15	Taper Punch, 1/4" x 6-3/4"
2	4600-14	Taper Punch, 3/16" x 6-1/4"
3	4600-13	Taper Punch, 5/32" x 6"
4	4600-3	Cold Chisel, 3/8" x 5-1/2"
5	4600-2	Cold Chisel, 1/2" x 6"
6	4600-1	Cold Chisel, 5/8" x 6-1/2"
7	4600-4	Center Punch, 3/16" x 8"
8	4600-5	Center Punch, 1/8" x 5"
9	4600-12	Taper Punch, 1/8" x 5-3/4"
10	4600-11	Taper Punch, 3/32" x 5-1/4"
11	4600-10	Pin Punch, 3/32" x 4-1/4"
12	4600-9	Pin Punch, 1/8" x 4-3/4"
13	4600-8	Pin Punch, 5/32" x 5"
14	4600-7	Pin Punch, 3/16" x 5-1/4"
15	4600-6	Pin Punch, 1/4" x 5-3/4"
16	4600-16	Chisel Gauge

OTC BFH HAMMER LINE

OTC No.	Head Weight	Handle Length	Total Weight
Double Face Sledge Hammer, Indestructible Handle			
5790ID-616	6 lbs.	16"	7.6 lbs.
5790ID-624	6 lbs.	24"	9.4 lbs.
5790ID-630	6 lbs.	30"	10.4 lbs.
5790ID-812	8 lbs.	12"	8.9 lbs.
5790ID-816	8 lbs.	16"	9.7 lbs.
5790ID-824	8 lbs.	24"	11.2 lbs.
5790ID-830	8 lbs.	30"	12.4 lbs.
5790ID-1030	10 lbs.	30"	14.0 lbs.
5790ID-1230	12 lbs.	30"	16.6 lbs.
5790ID-1430	14 lbs.	30"	18.5 lbs.
Club/Hand Drill Hammer, Indestructible Handle			
5791ID-312	2.5 lbs.	12"	4.0 lbs.
5791ID-412	4 lbs.	12"	5.1 lbs.
5791ID-416	4 lbs.	16"	5.5 lbs.
Cross Peen Hammer, Indestructible Handle			
5792ID-216	2 lbs.	16"	4.5 lbs.
5792ID-316	3 lbs.	16"	5.4 lbs.
Ball Peen Hammer, Indestructible Handle			
5793ID-2414	24 oz.	14"	2.6 lbs.
5793ID-3214	32 oz.	14"	3.0 lbs.
Tire Service Hammer, Indestructible Handle			
5789ID-1032	10 lbs.	32"	14.4 lbs.
5789ID-520	5 lbs.	20"	7.3 lbs.

5790-PACK Hammer Display
Includes 23 popular hammers for everyday use:



Part Number	Qty
5790ID-624	2
5790ID-630	1
5790ID-824	2
5790ID-830	1
5790ID-1030	1
5790ID-1230	1
5790ID-1430	1
5791ID-312	2
5791ID-412	2
5791ID-416	2
5792ID-216	2
5792ID-316	2
5793ID-2414	2
5793ID-3214	2
5700-DISPLAY	1

5700-DISPLAY Hammer & Tire Service Display Rack

- Designed to display various products in the framed rack, complete with removable rear sign holder.
- Sturdy display framed with heavy 5/16" rod with heavy steel base eliminates tipping.
- Black powder coat finish for a rust free, durable finish.
- Contains 2" x 2" = 52 slots and 2" x 4" = 6 slots.
- Includes 4 side hooks (not pictured).
- Assembled dimensions; W 18.5", D 19", H 44".
- Weighs approx. 35 lbs.



BFH Hammer

- Indestructible handle - never needs replacement
- Ergonomic rubber grip handle reinforced with steel bars resists breaking while absorbing impact and vibration.
- Drop-forged head is induction-hardened for long life, and contains steel locking plates that are specially bonded to ensure the head never becomes loose.
- Tire Service Features for 5789ID-1032 and 5789ID-520.
 - Use top hook as a wheel tipper; sledge end hook to drag tire into position.
 - Bead breaking wedge has grooves and a convex shape to help drive tire lube into the bead.



6939 Broken Bolt Extractor Tool

- Remove frozen, broken or cut off bolts within steering or suspension bushings.
- Can also be used to remove and install wheel studs and other general pressing needs.



6939-1 Broken Bolt Extractor Adapter Set

Available for use with the 7248 C-Frame.



7248 C-Frame Press

- Used for removing/installing; universal joints with needle bearings, pressed in wheel studs, and brake anchor pins on heavy-duty vehicles. Suitable for general pressing operations.





4605 Interchangeable Punch and Chisel Set

- Safety protective handle allows easy grip and protects hand from being hit by hammer.
- 12 punches and chisels included: 5 flat chisels: 1/2", 5/8", 3/4", 7/8", and 1" wide blades 1 cape chisel: 1/4" wide blade 2 taper punches: 1/8" and 1/4" diameter 2 pin punches: 3/16" and 1/4" diameter 2 center punches: 1/8" and 3/16" diameter
- Double locking ball detent holds punch or chisel securely in the driver handle.

- Replacement parts available:
- 4605-1** Drive handle
 - 4605-2** 1/2" wide flat chisel
 - 4605-3** 5/8" wide flat chisel
 - 4605-4** 3/4" wide flat chisel
 - 4605-5** 7/8" wide flat chisel
 - 4605-6** 1" wide flat chisel
 - 4605-7** 1/4" cape chisel
 - 4605-8** 1/8" taper punch
 - 4605-9** 1/4" taper punch
 - 4605-10** 3/16" pin punch
 - 4605-11** 1/4" pin punch
 - 4605-12** 1/8" center punch
 - 4605-13** 3/16" center punch



Impact Drivers

- Loosens hard-to-turn screws, bolts or nuts.
- Handle design prevents possibility of hitting hand with hammer when striking impact driver.
- Bit holder has 3/8" drive (No. 4608), 1/2" (No. 4607) drive, and 5/16" hex for Phillips and flat screwdriver bits.

• Includes eight screwdriver bits:

- No. 2 Phillips bit, 1-3/8" long with 5/16" hex
- No. 2 Phillips bit, 3-1/8" long with 5/16" hex
- No. 3 Phillips bit, 1-3/8" long with 5/16" hex
- No. 3 Phillips bit, 3-1/8" long with 5/16" hex
- 5/16" wide x 1-3/8" long with 5/16" hex slotted bit
- 5/16" wide x 3-1/8" long with 5/16" hex slotted bit
- 3/8" wide x 1-3/8" long with 5/16" hex slotted bit
- 3/8" wide x 3-1/8" long with 5/16" hex slotted bit

- 4607** 1/2" Impact Driver.
- 4608** 3/8" Impact Driver.



4406 Adjustable Bearing Race and Seal Driver

- Universal and fully adjustable.
- Twist head to adjustable from 3/4" to 3.5" (19mm to 89mm).
- Lock bolt holds jaws to preferred diameter.
- Steel striking cap mounted on aluminum handle and head provides a weight under 2 lbs.

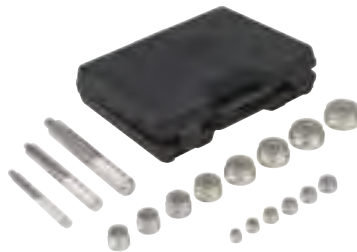

4407 Metric Bushing Driver Set

- 14-piece tool kit for motorcycles, Asian and European vehicles contains adapters: 10-12 mm, 14-16 mm, 15-17 mm, 16-18 mm, 18-20 mm, 20-22 mm, 22-24 mm, 25-27 mm, 28-30 mm, 30-34 mm, 32-36 mm, 35-40 mm, 38-42 mm; one small driver handle; one medium driver handle; one large driver handle.
- Aluminum construction won't mar the bushing or affect bushing tolerance, which is critical for efficient operation of the engine, transmission, and hubs.



4408 Bearing Race and Seal Driver Kit

- The Bearing Race and Seal Driver Kit provides a convenient way to smoothly and quickly position a bearing in the inner hole of an axle.
- The kit includes a handle grip and six heavy-duty bearing drivers. The drivers have different diameters in order to match different-sized bearings, and three of the drivers are formed with two different diameters.
- Bearing Driver Sizes:
1.555" (39.5 mm) 1.752" (44.5 mm)
1.968" (50.0 mm) 2.322" (59.0 mm)
2.48" (63.0 mm) 2.559" (65.0 mm)
2.834" (72.0 mm) 2.992" (76.0 mm)
3.189" (81.0 mm)



4410 Master Bushing Drive Set (33 piece Metric & Standard)

- Enables you to remove and install bushings ranging from 10mm to 42mm in diameter, and 3/8" to 1-3/8" in diameter, as used import cars, trucks, tractors, construction equipment, electric motors, and many other components having bushings.
- Includes large, medium, and small driver handles and adapters all made of steel.
- Housed in a blow-molded storage case.



4505 Bushing Driver Set, 19 piece

- Enables you to remove and install bushings ranging from 3/8" to 1-3/8" in diameter, as used in cars, trucks, tractors, construction equipment, electric motors, & many other components having bushings.
- Includes: Large, medium, and small driver handles with nuts; sixteen bushing adapters ranging from 3/8" to 1-3/8".
- Housed in a blow-molded storage case.



4507 Bearing Race and Seal Driver Set, 10 piece

- This aluminum constructed set permits installation of tapered bearing races and seals without damage to the component or housing.
- Tapered side of driver is used to install races. Invert the driver to the flat side to install seals.
- Set is housed in a blow-molded plastic storage case.
- Includes driver handle with bolt, plus these tool sizes: 1.565", 1.750", 1.965", 2.325", 2.470", 2.555", 2.830", 2.995", and 3.180".

SEAL & BEARING DRIVER SET

Now you can have the proper-size driver for nearly any automotive seal, bearing, or bushing installation job. These sets include discs and handles, spacers and drivers.

- Discs range from 1/2" to 4-1/2" in diameter, in 1/16" increments.

- 27793** Starter set. Includes a handle and discs (5/8" to 2" diameter) specially selected to provide the driver sizes usually needed in automotive service. Includes plastic storage box.
- 27794** Basic set. Includes two handle sizes and 41 discs, ranging from 1/2" to 3" diameter along with plastic storage box and insert.
- 27795** Big-job set for servicing large components. Includes a handle and 24 discs, ranging from 3-1/16" to 4-1/2" diameter.
- 27796** Intermediate set. Includes a handle and 25 discs, ranging from 2" to 3-1/2" diameter.
- 27797** Master set. Includes three handle sizes and 65 discs, ranging from 1/2" to 4-1/2" diameter.
- 27810** Tool organizer board for holding all components in No. 27797 master set.



27810



Starter Set 27793

Tool No.	Description	Tool No.	Description	Tool No.	Description
10012*	Cap Screw	27508	Disc, 1-9/16" dia.	27534	Disc, 3-3/16" dia.
10020*	Cap Screw	27509*	Disc, 1-5/8" dia.	27535	Disc, 3-1/4" dia.
10854*	Cap Screw	27510	Disc, 1-11/16" dia.	27536	Disc, 3-5/16" dia.
10855*	Cap Screw	27511*	Disc, 1-3/4" dia.	27537	Disc, 3-3/8" dia.
12001*	Cap Screw	27512	Disc, 1-13/16" dia.	27538	Disc, 3-7/16" dia.
27487*	Small Handle	27513*	Disc, 1-7/8" dia.	27539	Disc, 3-1/2" dia.
27488	Medium Handle	27514	Disc, 1-15/16" dia.	27540	Disc, 3-9/16" dia.
27489	Large Handle	27515*	Disc, 2" dia.	27541	Disc, 3-5/8" dia.
27490	Extension Tube	27516	Disc, 2-1/16" dia.	27542	Disc, 3-11/16" dia.
27491	Disc, 1/2" dia.	27517	Disc, 2-1/8" dia.	27543	Disc, 3-3/4" dia.
27492	Disc, 9/16" dia.	27518	Disc, 2-3/16" dia.	27544	Disc, 3-13/16" dia.
27493*	Disc, 5/8" dia.	27519	Disc, 2-1/4" dia.	27545	Disc, 3-7/8" dia.
27494	Disc, 11/16" dia.	27520	Disc, 2-5/16" dia.	27546	Disc, 3-15/16" dia.
27495*	Disc, 3/4" dia.	27521	Disc, 2-3/8" dia.	27547	Disc, 4" dia.
27496	Disc, 13/16" dia.	27522	Disc, 2-7/16" dia.	27548	Disc, 4-1/16" dia.
27497*	Disc, 7/8" dia.	27523	Disc, 2-1/2" dia.	27549	Disc, 4-1/8" dia.
27498	Disc, 15/16" dia.	27524	Disc, 2-9/16" dia.	27550	Disc, 4-3/16" dia.
27499*	Disc, 1" dia.	27525	Disc, 2-5/8" dia.	27551	Disc, 4-1/4" dia.
27500	Disc, 1-1/16" dia.	27526	Disc, 2-11/16" dia.	27552	Disc, 4-5/16" dia.
27501*	Disc, 1-1/8" dia.	27527	Disc, 2-3/4" dia.	27553	Disc, 4-3/8" dia.
27502	Disc, 1-3/16" dia.	27528	Disc, 2-13/16" dia.	27554	Disc, 4-7/16" dia.
27503*	Disc, 1-1/4" dia.	27529	Disc, 2-7/8" dia.	27555	Disc, 4-1/2" dia.
27504	Disc, 1-5/16" dia.	27530	Disc, 2-15/16" dia.	7350*	Allen Wrench
27505*	Disc, 1-3/8" dia.	27531	Disc, 3" dia.		
27506	Disc, 1-7/16" dia.	27532	Disc, 3-1/16" dia.		
27507*	Disc, 1-1/2" dia.	27533	Disc, 3-1/8" dia.		

NOTE: All discs are 1/2" thick. *Included in set No. 27793.

5550
Spectrum Solar 10W
LED Work Light with
UV Top Light



5550 Specifications

10W LED Work light with UV Top Light
LI-ION Rechargeable Battery – 3.6V 2250 mA, AC/DC
Charger Input AC 100 ~ 240V; 50/60Hz; DC12V ~ 24V
Power Output: 5.0V 1000 mA
Charger Time: 3.5 ~ 4.0 hours
Active Time: 2.5 hours
Storage Temperature: -4°F to 158°F; -20°C to 70°C
Operating Temperature: 23°F to 122°F; -5° to 50°C
PS: LED Sector: 170°
At 50 cm: 350 LUX (750 LM)
Waterproof Grade IP65

5551
Spectrum Trio 9W LED
Work Light with 3W
LED Top Light



5551 Specifications

9W LED Work light with 3W LED Top Light
LI-ION Rechargeable Battery – 3.6V 2250 mA, AC/DC
Charger Input AC 100 ~ 240V; 50/60Hz; DC12V ~ 24V
Power Output: 5.0V 1000 mA
Charger Time: 3.5 ~ 4.0 hours
Active Time: 3.0 hours
Storage Temperature: -4°F to 158°F; -20°C to 70°C
Operating Temperature: 23°F to 122°F; -5° to 50°C
PS: LED Sector: 25°
At 50 cm: 4000 LUX
Waterproof Grade IP65

5552
Spectrum 30+4
30 Pc. LED Work Light
with 4 Pc. LED Top
Light



5552 Specifications

30 Piece LED Work light with 4 Piece LED Top Light
LI-ION Rechargeable Battery – 3.6V 2250 mA, AC/DC
Charger Input AC 100 ~ 240V; 50/60Hz; DC12V ~ 24V
Power Output: 5.0V 1000 mA
Charger Time: 3.5 ~ 4.0 hours
Active Time: 4.0 to 5.0 hours
Storage Temperature: -4°F to 158°F; -20°C to 70°C
Operating Temperature: 23°F to 122°F; -5° to 50°C
PS: LED Sector: 15°
At 50 cm: 2250 LUX
Waterproof Grade IP65

- AC/DC Rechargeable
- Li-Ion battery
- Magnetic base
- Bright LEDs - 50,000 hour life
- Adjustable 60° angle
- Slip resistant textured body
- Impact & Waterproof Grade IP65
- Limited Lifetime Warranty



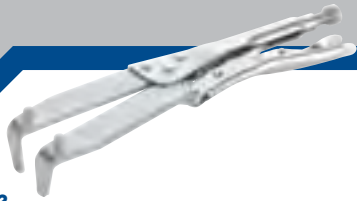

**4802
Universal Pulley Holder Locking Pliers**

This adjustable locking pliers can be used to hold pulleys, clutch hubs, flywheels, gears, and sprockets with internal or external teeth up to a 4" diameter. Can also be used on applications with slots or holes with the 5/16" pins.

**4803
Universal Pulley Holder Locking Pliers Set**

This adjustable locking pliers can be used to hold pulleys, clutch hubs, flywheels, gears, and sprockets with internal or external teeth up to a 4" diameter. Can also be used on applications with slots or holes with the addition of the interchangeable 5, 6, 7, 10, and 16mm pin sets. Complete with metal carry case.



Tool No.	Size
7011-1	.375" 10 mm
7011-2	.500" 13 mm
7011-3	.625" 16 mm
7011-4	.750" 19 mm
7011-5	.875" 22 mm
7011-6	1.00" 25 mm
7011-8	1.25" 32 mm
7011-10	1.50" 38 mm
7011-12	1.75" 44 mm
7011-14	2.00" 51 mm

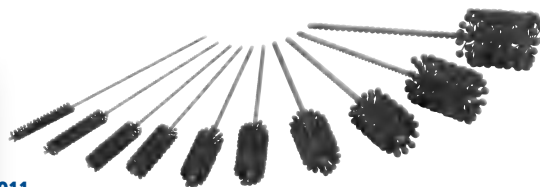

**7011
Ball Hone Set (10 piece)**

- Ball Hones can be used for refinishing and resizing bores such as found in brake calipers, engine lifters, and u-joint yokes. Also useful for any bearing or bushing application.
- All hones are 180 grit Silicone Carbide for excellent cutting and finish.



**4804
Heavy Duty Pulley Holder**

This strap style universal wrench features a 9" drop forged handle and 23" leather strap for excellent grip on diameters up to 7". The milled foot increases grip on the strap and pulley as handle force is increased.



**4491
Mechanic's Stethoscope**

- Quick and accurate way to locate vehicle noise.
- Spring diaphragm on end of hose amplifies noise.
- Includes two hose ends: long rod helps pinpoint noises in hard-to-access areas; short adapter helps locate noise in a broader area of the vehicle.



**2423
Stainless Steel Tip Blow Gun**

- Designed for operating pressure of 50 PSI to 235 PSI and temperature range of 14° to 158°F.
- When inlet pressure is 90 PSI, venting design prevents pressure exceeding 30 PSI if tip becomes blocked - conforming to OSHA Std. 1-13.1
- When inlet pressure is 100 PSI, the noise level is held below 80 db conforming to OSHA Std. 1910-95 (b), quieter than an electric drill
- 4-1/2" Stainless Steel Nozzle and Variable Speed Trigger for full control of amount of air dispensed
- Impact & Weather resistant materials and drop resistant construction
- Brass threaded air inlet



**2424
PRO Series Safety Blow Gun (Standard Tip)**

- Die Cast Aluminum body is non corroding and made to last in the harshest environments
- Ergonomic body design and dip coated operating lever reduce fatigue
- Exclusive venturi mechanism uses side ports to create higher volume of usable output
- Tamper-Proof design reduces output to safe levels if ports are blocked
- Meets OSHA standards for Safety and Noise



**1630
OTC 2-Drawer Service Cart**

The cart features 5" oversized casters (2-locking; 2-non-locking), an ergonomic grip handle, screw driver storage, locking top and gas shocks to support the lid. The cart has a 500-pound load capacity and stands 39.5" tall, 33.25" wide and 20" deep. The bottom tray is perfect for bulkier storage items, like rags, cleaners and solvents. The top bin is 5" tall and houses the drawer locking mechanism. The first drawer is 3.25" tall and the second drawer is 4.25" tall, both with a generous 20" depth. Safely store diagnostic hardware, cameras and expensive tools securely and within arms reach. OTC Lifetime Warranty.



**6043
Cooling System Power Flush Gun**

Perfectly suited for quick and efficient cooling system flushing. Simply attach it to radiator or heater hoses and you're in business. Also usable in washing engines and even shop floors. Two simple connections: one to shop air and one to a typical water faucet. No. 6043 creates a unique vortex air/water blast for powerful cleaning applications.

Note: While normal water pressure will handle the majority of a cooling system flush, short blasts are sometimes needed to loosen some contaminants from within the system.



PULLERS

Puller "How-to" Information	120 – 121
Puller Safety Tips	121
Protective Blankets	121
Mechanical "Grip-O-Matic" Pullers	122
Mechanical Push-Pullers and Pulling Adapters	123
Hydraulic Push-Pullers	124 – 125
Hydraulic "Grip-O-Matic" Pullers	126
Bearing Splitters and Pulling Attachment	127
Slide Hammer Pullers	128 – 129
Differential Bearing Pullers	130
Blind Hole Pullers, Bearing Pullers, and A/C Clutch Pulley	131 – 132
Flange-Type Pullers	133
17-1/2 – 50-Ton Puller Sets	134 – 136

YOU CAN SOLVE THE 3 BASIC PULLING PROBLEMS...

The first thing you have to do is identify exactly what your particular pulling problem is. Once you recognize the problem, you can go on to select the right tool to solve it.

HOW TO SELECT THE RIGHT PULLER

- 1: Determine the type of puller or puller combination. Which puller type is best for "getting a grip" on the part? Is a combination of puller types required?
- 2: Determine the "REACH" needed. The puller you select must have a "reach" equal to or larger than the corresponding sizes of the part.
- 3: Determine the "SPREAD" needed. The width of the part to be pulled will determine the "spread" required.
- 4: Estimate the force required. A puller with the correct "reach" and "spread" will usually have enough power. When in doubt, always use the next larger size. More power may be needed for rusted parts, or when the "area of resistance" is large.

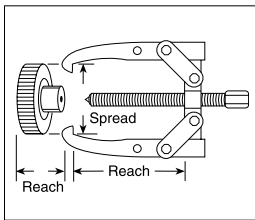

GENERAL RULE OF THUMB:

Manual pullers require that the puller screw be at least half as large (in diameter) as the shaft of the pulling job.

Hydraulic pullers need the maximum force exerted in tons to be 7–10 times the diameter of the shaft in inches.

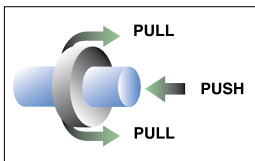

1 PULLING SOMETHING OFF A SHAFT.

Removing a gear, bearing, wheel, pulley, etc., to replace it or get at another part.

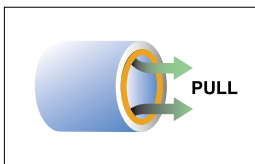

2 PULLING SOMETHING OUT OF A HOLE.

Internal bearing cups, retainers, or oil seals are usually press-fitted and are difficult to remove.

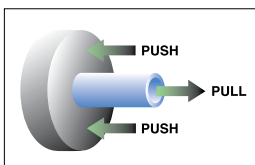

3 PULLING A SHAFT OUT OF SOMETHING.

A transmission shaft or pinion shaft is often hard to remove from a bore or housing. Use a Push-Puller with adapters if you can "get a hold of" the threaded end of the shaft. Sometimes it's possible to push a shaft through a housing, rather than pull it out. In applications of this type, the puller legs must be securely fastened to the housing and the screw may simply bear against the shaft.

The tools to use when pulling something off a shaft:

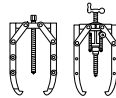

Jaw-type puller, either manual or hydraulic. (For extra force and convenience use a hydraulic puller.) Both are available in 2- or 3-jaw versions and are used to grip the outer circumference of an attachment.

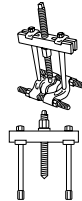

Bearing pulling attachment. Provides "knife-like" edges to get behind the component, or when there isn't a good gripping area on the part to be pulled. The splitter gets behind the component to prevent damage to the part.

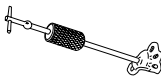

Push-Puller® with attachments. External-internal adapters can thread directly into tapped holes on a component.



Slide hammer puller with selected attachments for multiple light-duty pulling tasks.

A variety of OTC adapters can be used to protect a shaft, bridge a hole, thread into tapped holes, or assist installation.

The tools to use when pulling something out of a hole:

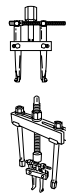

Internal pulling attachments have narrow jaws which extend through the center of the part to be pulled. They provide a straight pull and avoid damage to housings. Designed for use with Push-Pullers or slide hammer pullers.

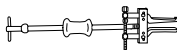

Push-Puller in combination with internal pulling attachment. Both mechanical and hydraulically powered versions are available.



Here a slide hammer puller is combined with an internal pulling attachment. Ideal for removing parts from blind holes, especially when there is no housing to brace puller legs against.

When there is a shaft to bear against, a forcing screw of the correct size may be used in combination with an internal pulling attachment.

The tools to use when pulling a shaft out of something:



Push-Puller® with threaded adapter. Use a mechanical or hydraulic puller, depending on the size of the shaft to be pulled.



When the housing lacks sufficient surface for the puller legs to bear against, a pulling attachment may be used to provide support.

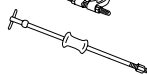

Slide hammer puller with threaded adapter – either external-internal or internal can be used.



Internal adapters are fastened to the external threaded end of the shaft to pull while pushing against the housing.

External-internal adapters are threaded into the shaft to pull it while pushing against the housing.

SAFETY PRECAUTIONS

⚠ WARNING: TO PREVENT PERSONAL INJURY WHEN USING PULLERS,

- Wear approved eye protection, such as safety glasses, goggles, or a face shield.
- Inspect puller for dents, cracks, or excessive wear before use. Inspect forcing screw for signs of galling or seizing. Replace worn or damaged components.
- Do not exceed puller's rated capacity, spread, or reach. Use correct size of puller for application.
- Ensure puller is correctly aligned with application and seated on component to be removed. Jaws must be parallel to forcing screw.
- Do not use wrench extensions when applying a load.
- Cover application with a shield or protective blanket before force is applied to contain flying debris should breakage occur.
- Apply force gradually. Do not use an impact wrench to apply force unless instructions specify use with an impact wrench.
- Do not strike or "sledge" puller or component.
- Do not modify puller by grinding, heating, or other means that could weaken puller strength.



ABOUT MECHANICAL PULLERS

A pulling system can exert tons of force and it is difficult to predict the exact force required for a pulling application. It is important to observe safety precautions when using a puller.

The OTC pulling system is versatile. For that reason, it is possible that various components in a pulling setup will have different tonnage ratings. The lowest capacity component determines the capacity of the entire setup. For example, when an accessory having a capacity of one ton is used with a 10-ton capacity puller, the puller setup can be used at a force of only one ton.

If you are unsure which puller or attachment to select for an application, contact your OTC tool representative or Service Solutions, LLC.

PULLER OPERATION

1. Mount the puller so its grip is tight. When using a jaw-type puller, tighten the adjusting strap bolts. For a better grip and more even pulling power, use a 3-jaw puller when possible.
2. Align puller legs and jaws. Verify the setup is rigid and the puller is square with the application.
3. Use the correct size of puller for the application. If you have applied maximum force and the component has not moved, switch to a larger capacity puller.

4. Apply force gradually. The component should give a little at a time. Do not try to speed up the application by using an impact wrench on the forcing screw.
5. Do not couple puller legs. The tonnage capacity of the puller is reduced when longer-than-standard legs are used or when legs are compressed, increasing the chance of breakage.
6. Keep reach to a minimum. Use the shortest legs possible to reach the component to be removed.
7. Install threaded puller legs evenly into the component, attachment, or adapter. Uneven legs result in greater force applied to one side of the puller, which can result in breakage.
8. Sliding plates must be on the opposite side of the cross block from the forcing screw nut or hydraulic cylinder.
9. Bearing pulling attachments may not withstand the full tonnage of the pullers with which they are used. The shape and condition of the component being pulled affects the tonnage at which puller blocks and / or studs may bend or break. Select the largest attachments that fit the component being pulled.

PULLER MAINTENANCE

Keep the puller clean, and frequently lubricate the forcing screw from threads to tip.

Protective Blankets

Think of them as "security blankets." They wrap around pulling, pressing, and other high-force jobs to protect you and your employees from work-related injuries as much as possible. They're made of high tensile, tear resistant ballistic nylon – similar to military flak jackets – that, when tested, withstood the shattering of a neck-down grade 8 bolt without any visible damage.

NOTE: Always reduce the force from the work piece prior to removing the blanket. Protective blankets may afford protection from injuries to users and others should part breakage occur. Because of the variety of situations that require guarding, it is the user's responsibility to determine the best method of protection.

1230PB

Protective blanket. 12" x 30"

2036PB

Protective blanket. 20" x 36"

2860PB

Protective blanket. 28" x 60"



1230PB



**FOR MORE DETAILS VISIT
OTCTOOLS.COM**

GRIP-O-MATIC® PULLERS

PROVIDING AUTOMOTIVE SERVICE SOLUTIONS FOR OVER 80 YEARS

Mechanical Grip-O-Matic® Pullers

OTC has developed the most complete line of gear and bearing pullers, enabling you to remove and install parts for fast, effective repairs. The pullers are forged from quality steel, heat treated, and subjected to rigorous tests which exceed their rated capacity.

No. 1020–1050

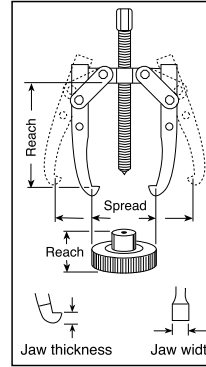
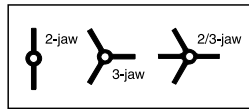

WARNING

Wear approved eye protection when using pullers. See page 121 for protective blankets for your pulling jobs.

	Tool No.	Capacity Style and Weight	Max Reach	Spread	Screw Size	Jaw Thickness	Width
	1020	1-Ton, 2-Jaw; 5 oz.	2-1/8"	3-1/4"	5/16"–24 x 3-7/8"	9/64"	1/4"
	1021	1-Ton, 3-Jaw; 8 oz.	2-1/8"	3-1/4"	5/16"–24 x 3-7/8"	9/64"	1/4"
	1022	2-ton, 2-Jaw; 14 oz. (Reversible Jaws)	3-1/4"	4"	3/8"–24 x 4-7/8"	Upper 3/16" Lower 1/8"	Upper 1/4" Lower 1/2"
	1023	2-ton, 2/3-Jaw; 1 lb., 5 oz. (Reversible Jaws)	3-1/4"	4-3/4"	3/8"–24 x 4-7/8"	Upper 3/16" Lower 1/8"	Upper 1/4" Lower 1/2"
	1024	5-Ton, 2-Jaw; 1 lb., 12 oz. (Reversible Jaws)	3-1/4"	6"	9/16"–20 x 6-15/16"	Upper 5/16" Lower 1/4"	Upper 3/8" Lower 3/4"
	1026	5-Ton, 2/3-Jaw; 2 lbs., 12 oz. (Reversible Jaws)	3-1/4"	7"	9/16"–20 x 6-15/16"	Upper 5/16" Lower 1/4"	Upper 3/8" Lower 3/4"
	1025	5-Ton, Long 2-Jaw; 2 lbs. (Reversible Jaws)	5-1/2"	6"	9/16"–20 x 6-15/16"	Upper 5/16" Lower 1/4"	Upper 3/8" Lower 3/4"
	1027	5-Ton, Long 2/3-Jaw; 3 lbs., 10 oz. (Rev. Jaws)	5-1/2"	7"	9/16"–20 x 6-15/16"	Upper 5/16" Lower 1/4"	Upper 3/8" Lower 3/4"
	1035	7-Ton, 2-Jaw; 4 lbs., 8 oz. (Reversible Jaws)	5"	9"	11/16"–18 x 9"	Upper 5/16" Lower 11/32"	Upper 1" Lower 1"
	1037	7-Ton, 2/3-Jaw; 6 lbs., 2 oz. (Rev. Jaws)	5"	10-1/2"	11/16"–18 x 9"	Upper 5/16" Lower 11/32"	Upper 1" Lower 1"

	Tool No.	Capacity Style and Weight	Max Reach Spread		Screw Size	Jaw Thickness	Width
	1036	7-Ton, Long 2-Jaw; 5 lbs., 6 oz.	8-3/4"	9-1/2"	11/16"-18 x 9"	11/32"	1"
	1038	7-Ton, Long 2/3-Jaw; 8 lbs., 2 oz.	8-3/4"	11"	11/16"-18 x 9"	11/32"	1"
	1039	13-Ton, 2-Jaw; 10 lbs., 13 oz.	11"	12"	13/16"-16 x 12"	9/16"	1"
	1041	13-Ton, 2/3-Jaw; 16 lbs., 4 oz.	11"	12"	13/16"-16 x 12"	9/16"	1"
	1040	13-Ton, Long 2-Jaw; 13 lbs.	15-1/4"	15-1/2"	13/16"-16 x 12"	9/16"	1"
	1042	13-Ton, Long 2/3-Jaw; 18 lbs., 12 oz.	15-1/4"	17"	13/16"-16 x 12"	9/16"	1"
	1043	17-1/2-Ton, 2-Jaw; 23 lbs.	14-1/2"	14"	1"-14 x 131/2"	13/16"	1-9/32"
	1045	17-1/2-Ton, 3-Jaw; 33 lbs.	14-1/2"	14"	1"-14 x 13-1/2"	13/16"	1-9/32"
	1044	17-1/2-Ton, Long 2-Jaw; 26 lbs.	18-3/4"	16"	1"-14 x 13-1/2"	13/16"	1-9/32"
	1046	17-1/2-Ton, Long 3-Jaw; 37 lbs.	18-3/4"	16"	1"-14 x 13-1/2"	13/16"	1-9/32"
	1047	25-Ton, 2-Jaw; 37 lbs., 8 oz.	15-1/2"	18"	1-1/4"-12 x 15-15/16"	1-1/16"	1-1/2"
	1049	25-Ton, 3-Jaw; 54 lbs.	15-1/2"	18"	1-1/4"-12 x 15-15/16"	1-1/16"	1-1/2"
	1048	25-Ton, Long 2-Jaw; 42 lbs., 12 oz.	22-1/4"	20"	1-1/4"-12 x 15-15/16"	1-1/16"	1-1/2"
	1050	25-Ton, Long 3-Jaw; 60 lbs.	22-1/4"	20"	1-1/4"-12 x 15-15/16"	1-1/16"	1-1/2"

PUSH PULLERS & THREADED ADAPTERS PULLERS

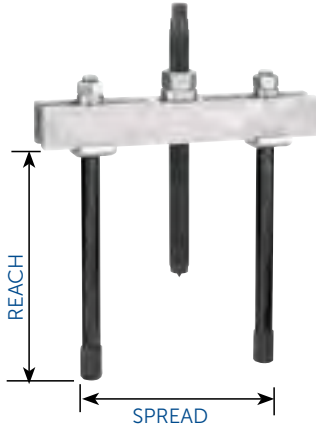

Push-Pullers®

927 10-Ton Capacity Can be used with No. 1123 bearing pulling attachment or No. 679 pulley pulling attachment. May also be used with Nos. 1150, 1151, 1152, or 1153 internal pulling attachments.

938 17-1/2 Ton Capacity Can be used with Nos. 1124 and 1130 bearing pulling attachments or Nos. 679 and 680 pulley pulling attachments. May also be used with Nos. 1150, 1151, 1153, 1165, or 1166 internal pulling attachments.

939 30-Ton Capacity Can be used with Nos. 1126 and 1127 bearing pulling attachments or No. 680 pulley pulling attachment (two 8012 adapters are required to connect 680 to puller). Can be used with No. 1165 internal pulling attachment.

Push-Pullers® Leg Extensions

Tool No.	Max. Reach	Max. Spread	Screw Size	Notes / Weight
927	8-1/4"	2-1/8" – 7-1/4"	3/4"–16 x 12"	1/2" of forcing screw tip end is threaded 5/8"–18. No. 1100 legs and No. 24827 leg ends included. Wt., 7 lbs.

Extra Legs (pair) for No. 927 Push-Puller (Reach equals leg length plus 1-1/2" with leg end caps.)

Tool No.	Leg Length & Wt.	Tool No.	Leg Length & Wt.
1103	4-3/4" 1 lb.	1102	11-3/4" 2 lbs., 4 oz.
1100	6-3/4" 1 lb., 8 oz.	1101	15-3/4" 3 lbs., 4 oz.

Tool No.	Max. Reach	Max. Spread	Screw Size	Notes / Weight
938	11-1/2"	3-1/8" – 11-3/4"	1"-14 x 13-1/4"	Leg ends threaded 5/8"–18. No. 1106 legs and No. 24827 leg ends included. Wt., 20 lbs., 12 oz.

Extra Legs (pair) for No. 938 Push-Puller (Reach equals leg length plus 2" with leg end caps.)

Tool No.	Leg Length & Wt.	Tool No.	Leg Length & Wt.
1107	4-1/2" 2 lbs., 8 oz.	1105	22-1/2" 9 lbs.
1106	9-1/2" 4 lbs., 8 oz.	1108	30" 11.5 lbs.
1104	16-1/2" 6 lbs., 8 oz.		

Tool No.	Max. Reach	Max. Spread	Screw Size	Notes / Weight
939	10-1/2"	7"–16-1/4"	1-1/2"–12 x 17-1/4"	Leg ends threaded 1"–14. No. 1109 legs and No. 28390 leg ends included. Wt., 44 lbs.

Extra Legs (pair) for No. 939 Push-Puller (Reach equals leg length plus 2" with leg end caps.)

Tool No.	Leg Length & Wt.	Tool No.	Leg Length & Wt.
1109	8" 8 lbs.	1111	28" 22 lbs.
1110	18" 15 lbs.		

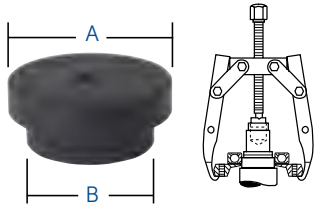

**8074, 8076 & 8075
Step Plate Adapter Sets**

Necessary for pulling and installing bearings, gears, or other parts found on hollow shafts or housings. They may be used with Grip-O-Matic® pullers and Push-Pullers®, as well as shop presses. All adapters are available separately.

Tool No.	Set No.	Dia. "A"	Dia. "B"
8057	•	1"	3/4"
8058	•	1-1/8"	7/8"
8059	•	1-1/4"	1"
8060	•	1-3/8"	1-1/8"
8061	•	1-5/8"	1-1/4"
8062	•	1-3/4"	1-3/8"
8063	•	1-7/8"	1-1/2"
8064	•	2"	1-5/8"
8065	•	2-1/8"	1-3/4"

Tool No.	Set No.	Dia. "A"	Dia. "B"
8066	•	2-3/8"	1-7/8"
8067	•	2-1/2"	2"
8068	•	2-5/8"	2-1/8"
8069	•	2-3/4"	2-1/4"
8070	•	2-7/8"	2-3/8"
8071	•	3"	2-1/2"
8072	•	3-1/4"	2-3/4"
8073	•	3-1/2"	3"

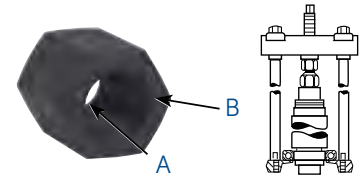

**8044
Internal Threaded Adapter Set**

For use on the ends of Push-Puller legs or forcing screws to aid in the removal and installation of shafts, axles, and housings.

Tool No.	Internal End "A"	Internal End "B"
8035*	1/2"-20	5/8"-18
8036*	1"-14	1"-14
8037	5/8"-18	5/8"-18
8038	5/8"-18	3/4"-16
8039	5/8"-18	7/8"-14
8040	5/8"-18	1"-14
8041	5/8"-18	1-1/8"-12
8042	5/8"-18	1-1/4"-12
8043*	5/8"-18	1-1/2"-12

* Not included in set No. 8044. Order separately. All adapters are available separately.

Metric and standard External-Internal Threaded Adapters

For use on the ends of Push-Puller legs or forcing screws when pulling shafts, bearing caps, pinions, etc.

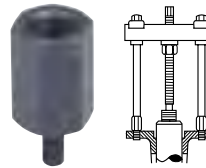

Tool No.	Internal End	External End	Length
Metric Threaded Adapters			
8111	5/8"-18	M6 x 1.0	2-1/4"
8112	5/8"-18	M8 x 1.0	2-1/4"
8113	5/8"-18	M8 x 1.25	2-1/4"
8114	5/8"-18	M10 x 1.25	2-1/4"
8115	5/8"-18	M10 x 1.5	2-1/4"
8116	5/8"-18	M12 x 1.25	2-1/4"
8117	5/8"-18	M12 x 1.75	2-1/4"
8121	5/8"-18	M14 x 1.5	2-1/4"
8122	5/8"-18	M14 x 2.0	2-1/4"
8123	5/8"-18	M16 x 1.5	2-3/4"
8124	5/8"-18	M16 x 2.0	2-3/4"
8125	5/8"-18	M20 x 1.5	2-3/4"
8126	5/8"-18	M20 x 2.5	2-3/4"
8131	5/8"-18	M6 x 1.0	1-5/8"
8132	5/8"-18	M8 x 1.25	1-5/8"
8133	5/8"-18	M10 x 1.5	1-5/8"
8134	5/8"-18	M12 x 1.75	1-5/8"
8135	5/8"-18	M14 x 2.0	1-5/8"
8136	5/8"-18	M16 x 2.0	1-5/8"
8137	5/8"-18	M20 x 2.5	1-5/8"
8141	1"-14	M16 x 1.5	3"
8142	1"-14	M16 x 2.0	3"
8143	1"-14	M18 x 1.5	3"
8144	1"-14	M20 x 1.5	3"
8145	1"-14	M20 x 2.5	3"
8146	1"-14	M22 x 1.5	3"
8147	1"-14	M24 x 2.0	3"
8148	1"-14	M24 x 3.0	3"

Tool No.	Internal End	External End	Length
Standard Threaded Adapters			
206437	1/2"-20	5/8"-18	2-1/4"
8000	5/8"-18	1/4"-20	2-1/4"
8001	5/8"-18	5/16"-18	2-1/4"
8002	5/8"-18	7/16"-14	2-1/4"
8003	5/8"-18	7/16"-20	2-1/4"
8004	5/8"-18	3/8"-24	2-1/4"
8005	5/8"-18	3/8"-16	2-1/4"
8006	5/8"-18	1/2"-20	2-1/4"
8007	5/8"-18	1/2"-13	2-1/4"
8008	5/8"-18	9/16"-18	2-1/4"
8009	5/8"-18	9/16"-12	2-1/4"
8010	5/8"-18	5/8"-11	2-1/4"
8013	5/8"-18	3/4"-16	2-1/4"
8015	5/8"-18	3/4"-10	2-1/4"
8017	5/8"-18	7/8"-14	2-1/4"
8018	5/8"-18	7/8"-9	2-1/4"
8019	5/8"-18	1"-14	2-1/4"
8022	5/8"-18	1/8" pipe	2-1/4"
8012	1"-14	5/8"-18	3-3/16"
8011	1"-14	5/8"-11	2-1/2"
8014	1"-14	3/4"-16	2-1/2"
8016	1"-14	3/4"-10	2-1/2"
8020	1"-8	5/8"-18	3"
8021	1"-8	1"-14	3"
8023	1-1/4"-12	1"-14	4-1/2"
8024	1-1/4"-12	1-3/4"-12	4-3/4"
8025	1-1/4"-7	5/8"-18	4"
8027	1-1/4"-7	1"-14	4"
8029	1-5/8"-51/2	1"-14	4"
8028	1-5/8"-51/2	1"-8	4"
8030	3/4"-16	5/8"-18	2-1/4"

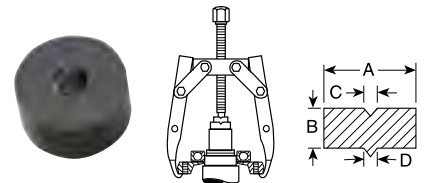

**8056
Shaft Protector Set**

Designed to protect shaft centers from distortion when extreme pressures are applied with either Grip-O-Matic® pullers or Push-Pullers. Shaft protectors are available separately.

Tool No.	"A"	"B"	"C" (60°)	"D" (60°)
8050	1-1/2"	3/4"	3/8"	7/16"
8051	1-1/4"	3/4"	3/8"	3/8"
8052	1"	3/4"	3/8"	5/16"
8053	3/4"	3/4"	1/4"	1/4"
8054	5/8"	5/8"	1/4"	1/4"
8055	5/8"	5/8"	3/16"	3/16"

HYDRAULIC PULLERS PULLERS



No. 1062 & 1063

Usable reach equals leg length minus 4-7/8" when using leg ends.

No. 1070 & 1071

Usable reach equals leg length minus 5-7/8" when using leg ends.

No. 1076

Usable reach equals leg length minus 10-5/8".

No. 1076 – 50-Ton Capacity Can be used with Nos. 1128 bearing pulling attachments. Ends of legs are threaded 1-1/4"-12. Usable reach: 13-3/8". See page 125 to order threaded adapters for use with these pullers.

Hydraulic Push-Puller®

No. 1062, 1063 – 17-1/2" Ton Capacity Can be used with Nos. 1124 and 1130 bearing pulling attachments or No. 680 pulley pulling attachment. May also be used with No. 1154 internal pulling attachment. Ends of legs are threaded 5/8"-18. Usable reach: 11-5/8".

Tool No.	Max. Reach	Max. Spread	Screw Size	Notes / Weight
1063	18-1/2"	5-3/4"-11-3/4"	1"-8 x 20"	Puller with No. 1104 legs, No. 24827 leg ends, No. 4120 hyd. ram, No. 32118 adjusting screw, and No. 24814 adjusting crank. 38 lbs.
1062	18-1/2"	5-3/4"-11-3/4"	1"-8 x 20"	Puller only. 22 lbs.

Extra Legs (pair) for No. 1062, 1063 (Reach equals leg length plus 2" with leg end caps.)

Tool No.	Leg Length & Wt.	Tool No.	Leg Length & Wt.
1107	4-1/2" 2 lbs., 8 oz.	1105	22-1/2" 9 lbs.
1106	9-1/2" 4 lbs., 8 oz.	1108	30" 11.5 lbs.
1104	16-1/2" 6 lbs., 8 oz.		

Note: 3/4"-14 thread on leg upper end.

LEG LENGTH

No. 1070, 1071 – 30-Ton Capacity Can be used with Nos. 1126 and 1127 bearing pulling attachments or No. 680 pulley pulling attachment (two No. 8012 adapters are required to connect No. 680 to puller). Also may be used with No. 1166 internal pulling attachment. Ends of legs are threaded 1"-14. Usable reach: 12-1/8".

Tool No.	Max. Reach	Max. Spread	Screw Size	Notes / Weight
1071	20-1/2"	7"-16-1/4"	1-1/4"-7 x 24"	Puller with No. 1110 legs, No. 28390 leg ends, No. 4121 hyd. ram, No. 34758 adjusting screw, and No. 27198 adjusting crank. 90 lbs.
1070	20-1/2"	7"-16-1/4"	1-1/4"-7 x 24"	Puller only. 56 lbs.

Extra Legs (pair) for No. 1070, 1071 (Reach equals leg length plus 2-5/8" with leg end caps.)

Tool No.	Leg Length & Wt.	Tool No.	Leg Length & Wt.
1109	8" 8 lbs.	1111	28" 22 lbs.
1110	18" 15 lbs.		

Note: 1"-14 thread on leg upper end.

Tool No.	Max. Reach	Max. Spread	Screw Size	Notes / Weight
1076	24"	8-1/2"- 20-1/2"	1-5/8"- 5-1/2" x 30-3/8"	Puller only. 106 lbs.

Extra Legs (pair) for No. 1076 (Reach equals leg length plus 1-1/4"-12 thd. on both leg ends.)

Tool No.	Leg Length & Wt.	Tool No.	Leg Length & Wt.
1112	24" 34 lbs.	1113	34" 47 lbs.

Hydraulic Grip-O-Matic® Puller

No. 1060-1080 Available in 10 to 50-ton capacities. Reliable single-acting Power Twin ram is matched with a versatile 2-jaw or 3-jaw puller. Lightweight ram can be used in other applications. You also get an adjusting screw, speed crank, and coupler where applicable. Hydraulic pump is not included; see index for pump listings.

Tool No.	MAX		Ram Capacity & Number	JAW		Screw Size & Crank No.	Style and Weight
	Reach	Spread		Thickness	Width		
1060	10"	17"	N/A	9/16"	1"	N/A	10-Ton, 2/3-Jaw; Puller Only; 17 lbs.
1065	11-1/2"	16"	17-1/2 Ton, No. 4120	13/16"	1-9/32"	1"-8 x 20" No. 24814	17-1/2 Ton, 2-Jaw; 40 lbs.
1064	11-1/2"	16"	N/A	13/16"	1-9/32"	N/A	17-1/2 Ton, 2-Jaw Puller Only; 24 lbs.
1067	11-1/2"	20"	17-1/2 Ton, No. 4120	13/16"	1-9/32"	1"-8 x 20" No. 24814	17-1/2 Ton, 3-Jaw; 53 lbs.
1066	11-1/2"	20"	N/A	13/16"	1-9/32"	N/A	17-1/2 Ton, 3-Jaw Puller Only; 37 lbs.
1073	19-7/16"	26"	30-Ton, No. 4121	1-1/8"	1-5/8"	1-1/4"-7 x 24" No. 27198	30-Ton, 2-Jaw; 91 lbs.
1072	19-7/16"	26"	N/A	1-1/8"	1-5/8"	N/A	30-Ton, 2-Jaw Puller Only; 59 lbs.
1075	19-7/16"	34"	30-Ton, No. 4121	1-1/8"	1-5/8"	1-1/4"-7 x 24" No. 27198	30-Ton, 3-Jaw; 122 lbs.
1074	19-7/16"	34"	N/A	1-1/8"	1-5/8"	N/A	30-Ton, 3-Jaw Puller Only; 90 lbs.
1080	19-7/16"	44"	N/A	1-1/8"	1-5/8"	N/A	50-Ton, 3-Jaw Puller Only; 187 lbs.

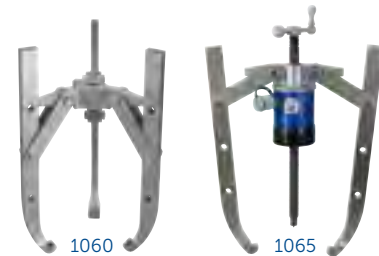

Puller components

No.	Description	Capacity
24814	Speed Crank	17-1/2 Ton
27198	Speed Crank	30 Ton
29595	Speed Crank	50 Ton
32118	Adjusting Screw	17-1/2 Ton
34758	Adjusting Screw	30 Ton
32698	Adjusting Screw	50 Ton
39448	Lube for pullers	

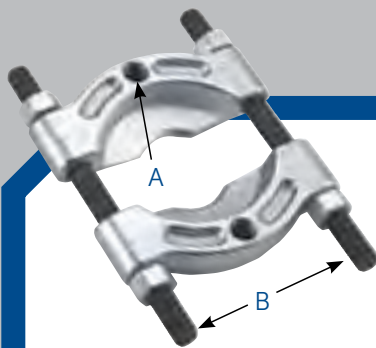

Bearing Splitters

No. 1121-1130 These versatile accessories feature "knife-like" edges which are easily placed behind the part to secure a gripping surface, even when clearances are extremely limited. When used with an OTC Grip-O-Matic® puller, puller jaws grip attachment's outer edge; when used with a Push-Puller, puller legs are threaded into the attachment's two tapped holes.

Tool No.	MAX. Spread	MIN. Spread	A	B	Weight	Application
1121	15/16"	1/4"	15/16"-18	1-11/16"	12 oz.	Use with puller Nos. 1020, 1022, & 1023.
1122	2"	1/8"	3/8"-16	2-7/16"	1 lb., 4 oz.	Use with puller Nos. 1024, 1025, 1026, 1027, 7392, & 7393.
1123	4-5/8"	1/2"	5/8"-18	4-3/8"	5 lbs.	Use with puller Nos. 1035, 1036, 1037, 1038, & 927.
1124	5-3/4"	1/2"	5/8"-18	6"	12 lbs.	Use with puller Nos. 1035, 1040, 1041, 1042, 1065, 1063, & 938.
1130	9"	1/2"	5/8"-18	6"	12 lbs., 9 oz.	Use with puller Nos. 1035, 1040, 1041, 1042, 1065, 1063, & 938.
1126	8"	5/8"	1"-14	7-1/8"	19 lbs., 12 oz.	Use with puller Nos. 1047, 1043, & 939.
1127	13-3/8"	3/4"	1"-14	10-1/4"	41 lbs., 12 oz.	Use with puller Nos. 1047, 1073, & 939.
1128	12-7/8"	5"	1-3/4"-12	13"	100 lbs.	Use with puller Nos. 1073, 1079.

A = Thread of tapped hole in adapter.
B = Distance between adjusting screws.

Pulley Pulling Attachments

Attachment clamps down into V-groove to distribute load. Use with Grip-O-Matic® pullers or Push-Pullers.

Tool No.	MAX. Spread	MIN. Spread	A	B	Weight	Application
679	5-7/8"	1-3/4"	5/8"-18	6"	4 lbs., 4 oz.	Use with puller Nos. 1035, 1036, 1037, 1038, and 927.
680	10"	1-5/8"	5/8"-18	10-1/16"	22 lbs., 4 oz.	Use with puller Nos. 1039, 1040, 1041, 1063, 1065, and 938.

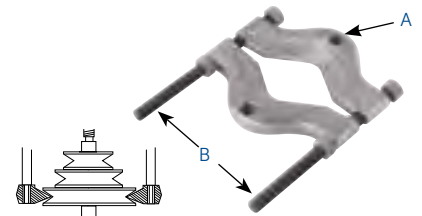

A = Thread of tapped hole in adapter.
B = Distance between adjusting screws.

Internal Pulling Attachments

Approved by leading bearing manufacturers, OTC's internal pulling attachments remove bearing cups, oil seals, bushings, and other parts from blind holes quickly and easily. Each attachment is designed for use with a corresponding Push-Puller or slide hammer assembly.

Tool	JAW Spread	JAW Reach	A	B	Weight	Application
1153	1-1/2"-5"	2-1/8"	1"-14	5/8"-18	4 lbs., 4 oz.	Use with Nos. 927 and 938 Push-Pullers, 1155 and 1156 slide hammer pullers, or 24832 and 24833 puller screw.
1150	1-1/2"-6"	4"	1"-14	5/8"-18	4 lbs., 4 oz.	
1152	1-1/2"-6"	4"	-	5/8"-18	3 lbs., 8 oz.	
1151	1-1/2"-7"	5-1/4"	1"-14	5/8"-18	4 lbs., 8 oz.	Use with Nos. 927 and 938 Push-Pullers, 1155 and 1156 slide hammer pullers, or 24832 puller screw.
1165	3"-9"	5-7/8"	1-1/2"-12	1"-14	13 lbs., 8 oz.	Use with No. 939 Push-Puller.
1154	1-1/2"-9"	4"	1"-8	5/8"-18	4 lbs., 8 oz.	Use with No. 1063 hyd. Push-Puller.
1166	3"-9"	5-7/8"	1-1/4"-7	1"-14	13 lbs., 8 oz.	Use with No. 1071 hyd. Push-Puller.

Puller Screws

24832	13-3/4" long		5/8"-18	1 lb.	Use with Nos. 1150, 1151, 1152, and 1153. Acts as a regular forcing screw when threaded directly into the block of pulling attachment.
24833	5-1/2" long		5/8"-18	6 oz.	Use with Nos. 1150, 1152, and 1153. Acts as a regular forcing screw when threaded directly into the block of pulling attachment.



1150-1166

A = Thread of tapped hole in adapter.
B = Distance between adjusting screws.

4420

Pilot Bearing Pulling Attachment

- Use to pull a pilot bearing from the end of the crankshaft.
- Interchangeable jaws. One set of jaws covers a spread of 1/2" to 1-1/2". Other set of jaws covers a spread of 3/8" to 1-3/8". Both sets of jaws have a reach of 1".
- Reach has a min/max range of 3/16" to 1".
- Puller attaches to OTC and other slide hammers with 5/8"-18 thread.



4421

Pilot Bearing Pulling Attachment

- Removes pilot bearings, thrust washers, and smaller bearings hidden in a shaft or housing.
- Jaws require a minimum of 5/8" opening and can range up to a max of 1-1/2" diameter.
- Min/Max reach is 1/8" to 1".
- Works with both 5/8 - 18 as well as M18-1.5 threaded hammer shanks.



4422

Pilot Bearing Puller

- Use to pull a pilot bearing from the end of the crankshaft.
- A restriction plate catches the bridge and prevents the jaws from spinning when force is engaged.
- The "Tee Handle" design is easy-to-use and eliminates need for other tools.
- Spread covers ranges of 1/2" to 1-1/2" and 3/8" to 1-3/8".
- Reach has a min/max range of 3/16" to 1-1/4".



REVERSIBLE-JAW SLIDE HAMMER PULLERS

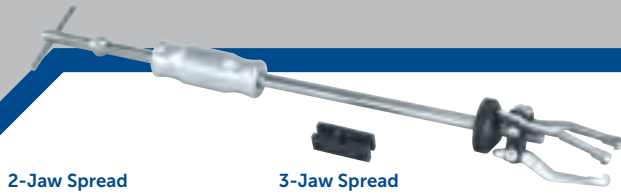

2-Jaw Spread				3-Jaw Spread				Overall Length
Inside		Outside		Inside		Outside		
Min.	Max.	Min.	Max.	Min.	Max.	Min.	Max.	
1-1/4"	3-1/2"	1"	4-1/2"	1-1/2"	4-1/4"	1-1/2"	4-1/2"	27"

Reversible-Jaw Slide Hammer Pullers

Here are two extremely versatile pullers, which will accomplish many pulling jobs involving gears, bearings, outer races, grease retainers, oil seals, etc. Either two or three puller jaws may be used to handle "inside" pulling jobs such as bearing cups and outer races, as well as regular "outside" pulling jobs. The basic slide hammer unit can be removed and used independently. The No. 1177 slide hammer puller has a 5 lb. hammer, and the No. 1176 has a 2-1/2 lb. hammer.

- 1176** Puller with 2-1/2 lb. hammer, 2-way and 3-way head, 27" long.
- 1177** Same as 1176, except has a 5 lb. hammer.



Spread		Reach	Overall Length
Min.	Max.		
1-5/8"	6"	4"	28"

Slide Hammer Pullers with Cup Pulling Attachments

These pullers combine a basic slide hammer unit with a No. 1152 internal pulling attachment (described on page 127). Ideal for removing bearing cups, outer races, and oil seals from blind holes. Upon removal of the internal pulling attachment, the basic slide hammer unit, which has a 5/8"-18 threaded end, may be used with various adapters for a multitude of pulling jobs.

- 1157** Slide hammer puller, consisting of an 1152 internal pulling attachment and an 1156 basic slide hammer unit with a 2-1/2 lb. hammer.
- 1158** Slide hammer puller (not shown), consisting of an 1152 internal pulling attachment and an 1155 basic slide hammer unit with a 5 lb. hammer.

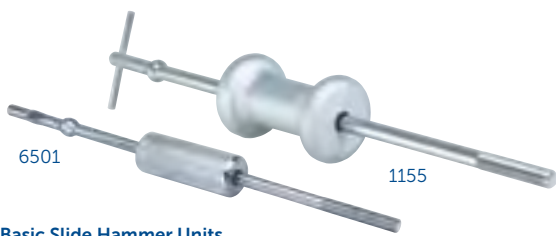

Basic Slide Hammer Units

May be used with an OTC internal pulling attachment (page 127), or with internal or external-internal threaded adapters (page 125).

- 1155** Slide hammer unit is 24" long with a 5 lb. hammer, 5/8"-18 threaded end.
- 1156** Slide hammer unit is 24" long with a 2-1/2 lb. hammer, 5/8"-18 threaded end.
- 6501** Slide hammer unit is 17" long with a 1-3/4 lb. hammer, 1/2-20 threaded end.

6541 Pulling Hook

- This slide hammer puller attachment is used to remove seals, bearings, and other press-fit parts.
- Designed to be used with OTC No. 1155 (5 lb.) or No. 1156 (2-1/2 lb.) slide hammer, or other slide hammers having 5/8-18 threads.



27315 Pulling Hook

- This slide hammer puller attachment is used oil seals and bearing in situations where conventional methods won't work.
- Designed to be used with OTC No. 1155 (5 lb.) or No. 1156 (2-1/2 lb.) slide hammer, or other slide hammers having 5/8-18 threads.



Sliding Hammers

- 22185** 2-1/2 lb. sliding hammer.
- 34331** 5 lb. sliding hammer.

Pilot Bearing Pullers

These very versatile pullers are built specially light duty for inside pulling jobs, and particularly for removing flywheel pilot bearings on automobiles, trucks, and tractors. Also very practical for pulling motor, generator, and magneto bearings.

Slide hammer unit is 17" long with a 1-3/4 lb. hammer, 1/2-20 threaded end.

Tool No.	Reach	I.D. Spread		Wt. (lbs./oz.)
		Min.	Max.	
1170	3/4"	1/2"	1-1/2"	4 / 14
1171	1"	7/8"	2-1/8"	4 / 14
1172	1-3/4"	1/2"	2"	4 / 14

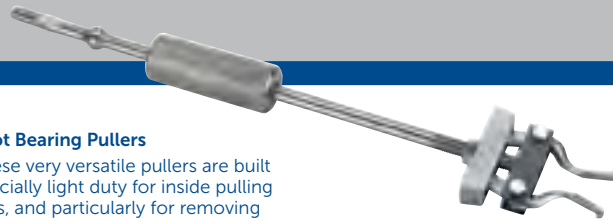

Special Slide Hammer Puller

Ideal for pulling jobs in very close quarters, as in removal of small-bore bushings, bearings, oil seals, etc. Internal pulling attachment has a jaw spread of 1/2" to 1-3/8", adjusted by turning the slide hammer handle. Handle end has a 1/2"-20 thread.

- 1173** Slide hammer unit is 17" long with a 1-3/4 lb. hammer, 1/2-20 threaded end. with 1174 head assembly.
- 1174** Head assembly only.

5028 Slide Hammer Puller

Just 8-1/2" long to fit into tight spots, but its 1-1/2 pound hammer gives you a little extra muscle for stubborn jobs. It's perfect for pulling injector nozzles. The shank is threaded 1/2"-20 and has a 5/8"-18 threaded adapter included. Works with many OTC pulling attachments.



7703 Ten-Pound Slide Hammer Puller

This heavy-duty slide hammer puller gets tough with those really stuck parts. It has all the features of our smaller versions - heat treated, 24" long, and a 5/8"-18 threaded end to adapt to any of OTC's pulling attachments. The difference is the ten-pound hammer that gives you the extra muscle for really stubborn pulling jobs.

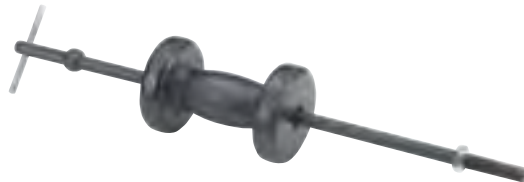



1176 Slide Hammer Puller Set

This useful set contains OTC's popular No. 1176 reversible-jaw slide hammer puller, plus an assortment of special jaws and adapters. You get all the versatility of the No. 1176 (described fully on page 128), plus attachments for pulling various size pilot bearings, oil seals, bushings, timing gears, harmonic balancers, and other tightly fitted parts!

Set No. 1178 consists of:

No.	Description
1176	Reversible-jaw slide hammer puller with 2-1/2 lb. hammer
44195	Medium jaw (3 include)
32054	Pilot bearing jaw (3 include)
34698	Short jaw (3 include)
44148	Long jaw (3 include)
27315	Puller hook. Removes oil seals, bearings, etc.
27241	2-way cross head
36578	Uses cap screws up to 3/8" diameter. Spread with 3/8" dia. cap screws: 1-7/8" - 5-5/8".

2-Jaw Spread

Tool No.	Inside		Outside	
	Min.	Max.	Min.	Max.
44195	1-1/2"	4-1/2"	3/4"	5"
32054	3/4"	2-3/8"	-	-
44148	2-3/4"	5-1/2"	3/4"	7-1/2"
34698	1-1/4"	3-1/2"	1"	4-1/2"

3-Jaw Spread

Tool No.	Inside		Outside	
	Min.	Max.	Min.	Max.
44195	1-1/2"	4-3/4"	1"	4-1/2"
32054	1"	2-3/4"	-	-
44148	3-1/4"	6-1/4"	1"	6-1/4"
34698	1-1/2"	4-1/2"	1-1/2"	4-1/2"

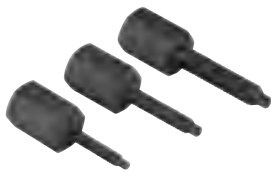

6627

Grip Wrench Adapters

- For grip wrenches using single-lead thread adjusting screw.
- Adapter threads onto a slide hammer with a 5/8"-18 thread.

205378 Grip wrench threads onto a 7/16"-14 end of adapter for pulling use.

557479 Grip wrench threads onto a 5/16"-18 end of adapter for pulling use.

557480 Grip wrench threads onto a 1/4"-20 end of adapter for pulling use.



1179 "Silver Slapper" 8-Way Slide Hammer Puller Set

You can pull flange-type rear axles, stubborn oil seals and bearings, and other press-fit parts. Jaws can be set up for 2/3-way internal or external pulling jobs.

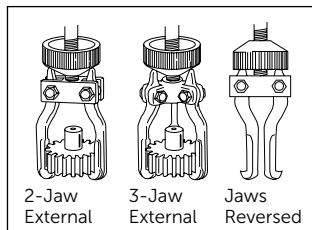

Application Examples

Set No. 1179 consists of:

No.	Description
1155	Slide hammer with 5 lb. hammer
7372	Rear axle pulling attachment
24544	3-way cross-head
24545	Cone
27241	2-way cross-block
27315	Puller hook attachment
34698	Pulling jaws (3) for internal or external pulling jobs
205378	Grip wrench adapter w/single lead (wrench not included)
205377	Dent puller attachment

5 lb. Hammer in Polished Chrome Finish.



4579

9-Way Slide Hammer Puller Set

- Pulls flange-type rear axles and most front-wheel drive hubs.
- Internal and external jaws provide a variety of combinations to pull bearings, gears and seals.
- Two- and three-way cross blocks and cone provide the perfect jaw configuration for most jobs.
- Set also includes a grip wrench adapter and a dent puller attachment for sheet metal or other unique pulling requirements.
- Designed for use with other OTC 5/8"-18 thread slide hammer attachments.
- Packaged in blow-molded case.



7792 Rear Axle Puller Set

The tools you need for flange-type rear axle and bearing removal on most late model passenger cars and light trucks. Set includes the No. 7374 rear axle pulling plate and a 5 lb. slide hammer. The axle bearing pullers, used with the slide hammer, make short work of removing semi-floating rear axle bearings.

Set No. 7792 consists of:

No.	Description
7374	Rear axle pulling plate with a 5 lb. slide hammer.
7495A	Rear axle bearing puller. Fits a min. bearing tube I.D. of 1" and a max. axle tube I.D. of 1-7/8".
7496A	Rear axle bearing puller. Fits min. bearing tube I.D. of 5/16" and max. axle tube I.D. of 2-3/8".
7497A	Rear axle bearing puller. Fits min. bearing tube I.D. of 1-3/8" and max. axle tube I.D. of 2-7/8".
27315	Puller hook for use with 5 lb. slide hammer in set. Removes oil seals, bearings, etc.



8-Way and 10-Way Slide Hammer Puller Sets

Our two most popular slide hammer puller sets—the Silver Slapper and the Silver Slapper Plus—now come packaged in a convenient plastic, blow-molded carrying/storage case. They're the same great sets with the same versatile pullers and attachments, now made even better with the addition of an organizer case. Or, if you already own either our No. 1179 or No. 1189 puller sets, we offer the plastic case separately. The case will hold either set.

7947 Eight-way slide hammer puller set. Same contents as No. 1179 Silver Slapper set, but includes plastic carrying/storage case.

7948 Ten-way slide hammer puller set.

63106 Puller storage case. Blow-molded plastic.

DIFFERENTIAL BEARING PULLERS PULLERS

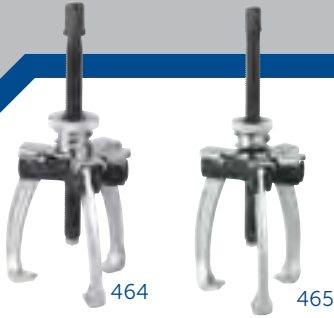

OTC "GripLock" Pullers

Manufactured to our rigorous specifications to ensure the quality professionals expect from OTC.

- Pressure bearing yoke cap holds jaws in place for ease of set up - in any orientation.
- 2 or 3 jaw application.
- Both external and internal pulling action.
- "Live Center" action forcing screw.
- Professional finished for long lasting durability...

464 Puller with a 4" maximum reach, 3" to 4" spread.

465 Puller with a 7" maximum reach, 3" to 7" spread.

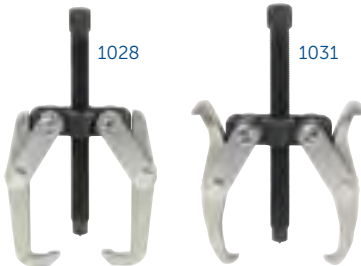

Differential Bearing Pullers

For removing differential side carrier bearings on a wide variety of passenger cars and light trucks. Use with step plate adapter Nos. 8060, 8061, 8063, and 8064. (Step plate adapters are not included with 1028 or 1031. See page 125.)

1028 Puller with a 3-1/2" maximum reach, 1-1/4" to 4-1/2" spread. Primarily for servicing Ford products.

1031 Puller with a 3-1/4" maximum reach, 6" maximum spread. For servicing most General Motors, American Motors, and Chrysler products.

Bearing Cup Remover

Ideal for servicing hubs on today's popular front-wheel-drive small cars. The cone holds the jaws in place during pulling. Perfect for pulling internal bearing cups, seals, bushings, etc. Jaw spread: 15/16" to 3-1/4", reach to 3-1/2". Use with any slide hammer having a 5/8"-18 thread (OTC No. 1155 or No. 1156 or the No. 927 Push-Puller).

6542 Bearing Cup Remover.

7136 Bearing Cup Remover. Similar to Ford 308-047.



4520 Differential Side Bearing Pullers

- Use to remove differential side carrier bearing. Works on a wide variety of cars and light-duty trucks.
- Includes four step plate adapters to fit carrier bearings.
- Reach: 1-5/8". Spread: 2-5/8" to 3-3/8". Forcing screw is 3/4"-16 x 6-11/16" lg.

Set includes:

4520-1 Forcing Screw / Cross Block Assembly

4520-2 Puller Jaws / Pins (set of two each)

4520-3 Puller Jaws Retaining Yoke

4520-4 Step Plate Adapters (set of four)

15/16" - 1-11/32" diameter

1-1/8" - 1-1/2" diameter

1-1/4" - 1-5/8" diameter

1-1/8" - 1-3/4" diameter

1181 Multipurpose Puller Set

This assortment of puller tools gives you a wide range of job versatility. You get a 5 lb. slide hammer puller, hub puller, two sizes of OTC Grip-O-Matic® jaw-type pullers, a bearing pulling attachment, plus a cross-bar gear and pulley puller, all contained in a handy plastic storage case.

Set No. 1181 consists of:

No.	Description
1177	Slide hammer puller with a 5 lb. hammer, 2-way and 3-way heads. Reversible: either two or three jaws may be used to handle both "inside" and "outside" pulling jobs.
7208A	Front hub puller for servicing front-wheel-drive cars. Includes a spare locknut, which permits use with a No. 1177 slide hammer for rear axle flanges.
1023	2-ton combination 2- or 3-jaw Grip-O-Matic puller. Has 3-3/8" max. reach, 4-3/4" max. spread.
1027	5-ton combination 2- or 3-jaw Grip-O-Matic puller. Has 5-1/2" max. reach, 7" max. spread.
7393	Bar-type gear and pulley puller with a 5-1/2" long screw. Includes two hex head cap screws, 3/8"-16 x 3" long. Spread range: 1-1/2" to 4-1/4".
1122	Bearing pulling attachment for use with No. 1027 and No. 7393 pullers. Has 2" max spread, 1/8" min. spread.



1184 Cone-type Puller

Reversible jaws permit handling of both internal and external pulling jobs. The 2-way/3-way head permits assembly of puller to suit the job at hand. Turning the cone on the puller head securely locks its jaws on the part to be removed. Puller reach: 2-7/8"

2-jaw spread:
Inside: 1-1/2" to 4-1/2"
Outside: 3/4" to 5"

3-jaw spread:
Inside: 1-1/2" to 4-3/4"
Outside: 1" to 4-1/2"



Specifications

Reach: 1-5/8"

Spread: 2-5/8" on inside holes in crossbar
3-3/8" on outside holes in crossbar

Forcing screw: 3/4"-16 mm x 6-11/16" lg.

Adapter sizes: 15/16" to 1-3/4" diameter

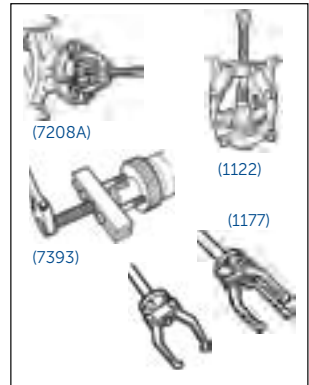

Pilot Bearing Pullers

Designed to pull flywheel pilot bearings in close quarters where a slide hammer cannot be used. Operates on many models with engine in chassis.

7318 Pilot bearing puller. Capacity: 1/2" to 1-1/2". I.D. reach: 3/4".

7319 Pilot bearing puller. Capacity: 7/8" to 2". I.D. reach: 1".

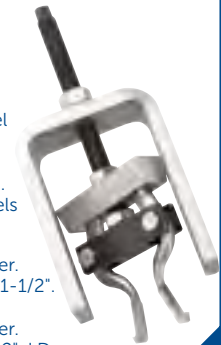



6981 Blind Hole Puller Set

Pilot bearings and pilot bushings are one of the most critical components in a transmission clutch system. Damage, wear, or contamination can result in binding on the input gear and may be revealed as the clutch drag symptoms or even a growling sound when clutch pedal is fully released. Address these problems with the 6981 blind hole puller set from OTC.

- 5 - collet actuator combinations cover 5/16" to 1-1/4" I.D.
- Use collets with Pulling Bridge or as Slide Hammer Attachment.
- Easy to read component application chart and instructions.
- Conveniently laid out in rugged blow mold storage case.
- Forged and machined in Owatonna Minnesota, U.S.A

Set No. 6981 consists of:

- 577564** Pin .140"
- 577565** Pin .200"
- 577566** Pin .280"
- 577567** Pin .400"
- 577568** Pin .500"
- 577569** Collet .300 to .350 (1.5" reach)
- 577570** Collet .350" to .438" (1.5" reach)
- 577571** Collet .438" - .563" (1.75" reach)
- 577572** Collet .563" - .865" (2.5" reach)
- 577573** Collet .865" - 1.25" (3" reach)
- 577574** Pin Adapter



4581 Blind Hole Bearing Puller Set

- For pulling jobs requiring an internal pull.
- Set includes four collets, which fit a wide range of applications. Select the appropriate sized collet by comparing it with the application. Insert the collet, expand it to fit the hole, then attach the slide hammer.
- Four collet sizes: 7/16" to 1/2", 9/16" to 11/16", 5/8" to 1", and 1" to 1-1/4".
- Set includes a 2-1/2 lb. slide hammer with a T-handle.
- Housed in a blow-molded plastic storage case.



4536 A/C Clutch Pulley Puller Set

- For removal of stubborn air conditioning clutch pulleys. Also can be used on many alternator, generator, power steering, and crankshaft pulleys, harmonic balancers, and fiber timing gears.
- Set includes drop-forged components: one 3/4"-16 x 5" live center forcing screw, 5-1/2" crossbar with 3 spread settings, two pairs of jaws, and a clamp bolt.
- Spread: 3" to 5"; Reach: 1" to 5".
- Includes a blow-molded plastic case.



4517 7-Ton Bar-Type Puller/Bearing Separator Set

- Includes a Bearing Splitter with 4" capacity, two sets of hex push puller legs, a 8" bar type puller head mated with a custom thread forcing screw.
- Now service and maintenance professionals have a Puller/Bearing set for tough jobs, up to 7-tons, larger applications, and greater reach 8" to 16".
- As a stand alone puller/bearing splitter set or as a compliment to the 4518 version, the 4517 7-Ton Puller/Bearing Separator Set gives your maintenance/service shop the expanded capability to keep more business in house.



4532 7-Ton Multi Purpose Bearing and Puller Set

- Offers a bearing/pulley tool solution featuring a classic "H" Bar style puller block accommodating 7" to 11" application spread.
- Comes with 2 sets of forged jaws for a pulling each range of 5" to 9" - tempered for heavy-duty applications. (Jaws from OTC's 4534 are interchangeable) Two forcing screws are included for short and long pulls.
- Where a Push Puller is the best pulling choice and threaded holes are not available, the 4532 provides technicians and shops with a solution for many applications like heavy-duty pinion bearings, side bearings, alternators, generators, power steering and crankshaft pulleys, timing gears and harmonic balancers.
- Deep set transmission gears and A/C clutches. Roller gears on tracked vehicles, locking collars on pivot shafts.

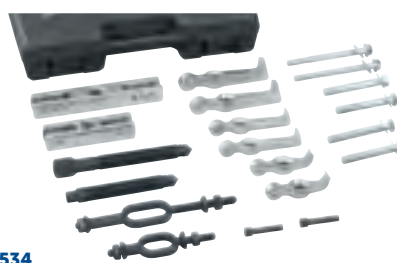

4534 Multipurpose Bearing and Pulley Puller Set

- For a wide range of pulling jobs, including: bearings, alternators, generators, power steering and crankshaft pulleys, timing gears, and harmonic balancers.
- Set includes drop-forged components, which can be used in a variety of combinations. Contents of Set: 2 - Forcing Screws (Live Center): 3/4"-16 x 6-11/16" and 3/4"-16 x 5" 2 - Cross-bar Yokes: 3 pin-hole @ 3-1/4" to 5-1/2", 2 pin-hole @ 2-3/8" to 3-3/8" 2 - Clamp Bolts 3 - Pairs of Puller Jaws: 1-3/8" Max, 1-5/8" Max, 1-3/4" Max 1 - Pair of Jaw Pins with Ball Spring 3 - Pairs of Capped Bolts
- Spread: 3" to 5", Reach: 1" to 2-1/4"
- Housed in a blow-molded plastic storage case.



4518 5-Ton Bar-Type Puller/Bearing Separator Set

- This combination set includes our two most popular bearing "splitters" (2" and 3"), four sets of hex push-puller legs and a bar-type puller head with a 9/16" forcing screw. Separator tools are used with bar puller and legs for a wide variety of pulling jobs.
- The 5" puller cross-bar with a 6-1/4" forcing screw or each of the bearing separators may also be used separately or in combination with other pullers or tools.
- A blow-molded plastic storage case keeps set contents organized and protected from loss.

Tool No.	Min. Spread	Max. Spread	Tapped Holes	Distance Between Adj. Screws
4518-2	3/16"	2-3/8"	3/8-16	2-3/8"
4518-3	1/2"	2-3/8"	3/8-16	3-9/16"



1182 Lock-on, Jaw-type Puller Set

Components can be assembled to create several versatile puller versions for both internal and external pulling tasks. The puller head is turned to securely lock the jaws onto the part being removed. Both a 2-way and 3-way puller head are included, plus three long-reach and three short-reach puller jaws. Plastic storage box included. Easily removes gears, bearings, timing gears, harmonic balancers, and other press-fitted parts.

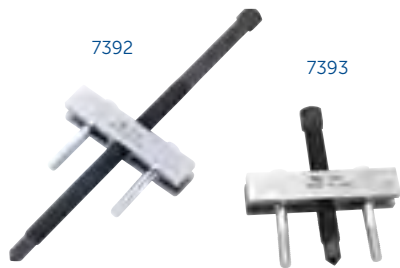

Gear and Pulley Pullers

These tools are perfect for removing timing gears, fan pulleys, harmonic balancers, and many other parts having tapped holes.

- Each puller will spread from 1-1/2" to 4-1/4". The puller blocks are 4-7/8" wide, tapped 5/8" - 18 UNF.
- Two hex head cap screws, 3/8"-16 x 3" long.

- 7392** Puller with 13" long screw
- 7393** Puller with 5-1/2" long screw



Similar to Ford D80L-522-A, 303-D025

522 Large Gear and Pulley Puller

Using this tool, you can easily remove a wide range of gears, pulleys, or other parts that have tapped holes.

- The spread is 2" to 7-3/4". Its block is 8-1/4" wide, and its forcing screw is 3/4"-16 x 11-5/8" long.
- Accommodates any cap screws up to 1/2" diameter.



1183 Bearing Splitter Combo Set

This combo pack contains four of OTC's most popular bearing splitters, plus a pulley pulling attachment. A rugged organizer case is included, enabling you to keep the tools together for instant use.

Set No. 1183 consists of:

No.	Description
1121	Bearing splitter. Has 15/16" max. spread and 1/4" min. spread.
1122	Bearing splitter. Has 2" max. spread and 1/8" min. spread.
1123	Bearing splitter. Has 4-5/8" max. spread and 1/2" min. spread.
1130	Bearing splitter. Has 9" max. spread and 1/2" min. spread.
679	Pulley pulling attachment with a 5-7/8" max. and 1-3/4" min. spread.



4526 Heavy-Duty Single Pressure Beam Bearing Splitter Set

- Single point of adjustment allows quick attachment of splitter to the application.
- Pressure beam provides the ultimate in secure gripping surface.
- Push Puller is thread matched to the splitter.
- Interchangeable legs shorten or lengthen the range of pull.
- Designed of high quality tool grade materials for a lifetime of use.
- For use on most bushing or bearing jobs up to 4" in diameter.

6614 Heavy-Duty Gear Puller

The OTC 6614 Heavy Duty Gear Puller will remove gears up to 7-1/4" in diameter, including most cam gears. Rated at 8 tons, this puller is stout enough for almost any heavy-duty application and includes a pair of metric bolts for most applications. The slimmer design of the cross block gives more room to set up in tight quarters.

The tempered steel, rust inhibitor-coated bolts are graded 10.9 and are sized M12x1.75" and are 90mm in length. Cam gears giving you fits? Covered by OTC's Lifetime Warranty.



1180 10-Ton Capacity Push-Puller Set

Contains three popular OTC bar-type pullers in one versatile set, packed in a handy plastic storage case. Tools included permit damage-free pulling of gears, bearings, harmonic balancers, and other parts having tapped holes. Ideal for servicing heavy-duty trucks, off-road construction equipment, and machinery.

Set No. 1180 consists of:

No.	Description
927	10-ton Push-Puller, 8-3/8" reach, 2-1/8" to 7-1/4" spread. 6-3/4" puller legs. Other leg sizes are available separately. (See pages 124, 126.)
522	Gear and pulley puller; spread range when used with 1/2" cap screws: 2" to 7-3/4". Cap screws not included.
7393	Gear and pulley puller with standard 5-1/2" forcing screw, plus special 13" forcing screw. Includes two hex head cap screws, 3/8"-16 x 3" long. Special range: 1-1/2" to 4-1/4".



4527 5-Ton Single Pressure Beam Bearing Splitter Set

- Single point of adjustment allows quick attachment of splitter to the application.
- Pressure beam provides the ultimate in secure gripping surface.
- Push Puller is thread matched to the splitter.
- Interchangeable legs shorten or lengthen the range of pull.
- Designed of high quality tool grade materials for a lifetime of use.
- For use on most bushing or bearing jobs up to 3" in diameter.

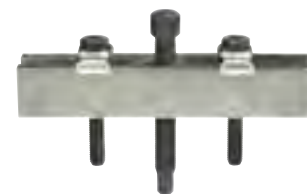



7790

Flange-Type Puller Set (Grade 5)

- Versatile puller capable of removing a wide variety of components having tapped pulling holes, including harmonic balancers, gears, crankshaft pulleys, etc.
- Capable of handling 2- or 3-way bolt pulling applications.
- Works on many cars, pickups, SUVs, and small engines.
- Carries the OTC Lifetime Marathon Warranty® against defects in workmanship and material.

Contents of set:

- Puller flange: adapts to bolt circle dia. of 1-1/2" to 4-5/8".
- Forcing screw: 5-5/8" lg., 5/8-18 thread.
- Shaft protector: 1-3/16" dia. x 3/4" thick.
- Three each of the following flat washers: 1/4"; 5/16"; 3/8".
- Three each of the following bolt sizes:

- 1/4"-28 x 3" lg.	- M8 x 1.25 x 45 mm lg.
- 5/16"-24 x 3" lg.	- M8 x 1.25 x 65 mm lg.
- 5/16"-18 x 3-1/2" lg.	- M8 x 1.25 x 90 mm lg.
- 5/16"-18 x 6" lg.	- M8 x 1.25 x 30 mm lg.
- 3/8"-24 x 1-1/2" lg.	- M10 x 1.5 x 35 mm lg.
- 3/8"-16 x 2" lg.	
- 3/8"-16 x 3" lg.	
- 3/8"-16 x 4-1/2" lg.	



525

Flange-Type Puller Combination

Two specialty pullers in one box. You get a flange-type puller for removal of harmonic balancers, timing gears, and other parts with two or three tapped holes. You also get a steering wheel, pulley, and flywheel puller.

525 includes: flange-type puller and steering wheel puller with four sets of cap screws.

3/8"-16 UNF x 3.5". 3/8"-24 UNF x 3.0". 5/16"-18 UNF x 3.5". 5/16"-24 UNF x 3.5".



7793

Master Bolt Grip Set (Grade 8)

- Multi-Purpose applications such as steering wheels, flywheels, harmonic balancers, pulleys and gears with tapped holes.
- Includes special stepped bolts for 1990-2005 GM 3300-3800 V6 crankshaft pulleys.

Contents of set:

- 4-way slotted puller yoke and 2 lengths of hardened "live-center" forcing screws - a set of 3 interchangeable forcing screw tips is included to optimize pressure and prevent "walking".
- Blow molded case to prevent spilling and each bolt size is molded into the storage compartment.
- Three each of the following bolt sizes:

- M8 x 1.25 x 90mm	- 3/8"-24 UNF x 1.5"
- M8 x 1.25 x 45mm	- 3/8"-16 UNC x 2"
- 1/4"-28 UNF x 3"	- 3/8"-16 UNC x 3"
- M8 x 1.25 x 65mm	- 3/8"-16 UNC x 4.5"
- 5/16"-24 UNF x 3"	- M10 x 1.5 x 35mm
- 5/16"-18 UNC x 3.5"	
- Special Stepped Bolts - 1990 & Newer



7403

Steering Wheel, Pulley, and Flywheel Puller

Here's a puller that works in a variety of applications. It pulls steering wheels on most late model cars. It also works as a regular 2/3-way puller to remove pulleys and small engine flywheels. Cap screws included (pairs): 3/8"-16 x 3-1/2 in.; 5/16"-18 x 3-1/2 in.; 5/16"-24 x 3-1/2 in.; M8-1.25 x 90 mm; and 5/16"-18 x 4 in. (SIR).

- Works on domestic cars with or without collapsible steering columns.

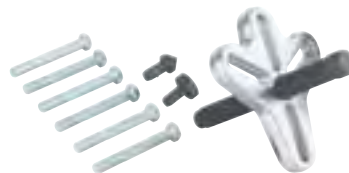

6930

Flange-Type Puller Combination

Heavy-duty flange puller features a live center forcing screw. Includes two live center forcing screw tips and two sets of commonly used automotive bolts. Puller will work on bolt circles from 1-1/2" to 4-1/4". Three cap screws, 3/8"-24 x 3" long, and three cap screws, 3/8"-16 x 3" long.



PA7

7-Ton Capacity Four-In-One™ Puller Set

With the parts included in the PA7, you can quickly assemble a 2/3-jaw puller with standard or long reach. 7-ton capacity, the max. reach of 8-3/4", and max. spread of 11" make it ideal for hundreds of pulling jobs. PA7 includes: 7-ton cap. Standard jaw max. reach: 5". Max. spread: 10-1/2". Long jaw max. reach: 8-3/4". Max. spread: 11".



518

Flange-type Puller

- Pulls harmonic balancers, timing gears, and other parts having two or three tapped holes.
- Slotted holes in puller body permit cap screws to be positioned to handle bolt circle diameters from 1-1/2" to 4-5/8"
- Three each of two cap screw sizes included: 3/8"-24 x 3" long and 3/8"-16 x 3" long.



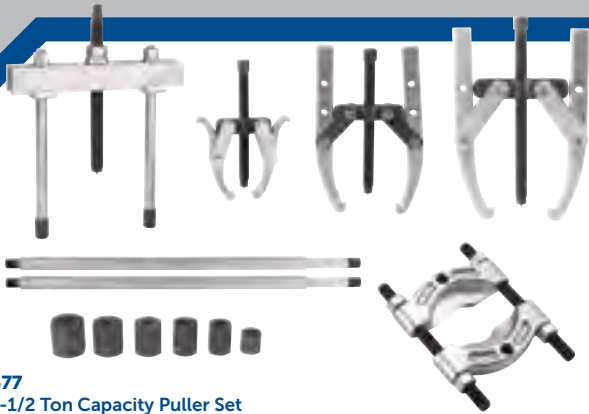

1677
17-1/2 Ton Capacity Puller Set

This puller set gives you the versatility you want and the tonnage capacity you need to tackle parts removal and installation on many models of cars, trucks, tractors, power shovels, road building machinery, etc. Maintenance operations involving the removal and replacement of gears, bearings, wheels, and other press-fit parts can be done with ease.

Set No. 1677 consists of:

No.	Description	No.	Description
938	Push-Puller with 9-1/2" legs		Internal threaded adapters
1104	16-1/2" legs for 938 (pair)	8037	5/8"-18 x 5/8"-18
1024	2-jaw puller	8038	5/8"-18 x 3/4"-16 (2)
1036	2-jaw puller	8039	5/8"-18 x 7/8"-14
1039	2-jaw puller	8040	5/8"-18 x 1"-14
1130	Bearing splitter	8041	5/8"-18 x 1-1/8"-12
		8043	5/8"-18 x 1-1/2"-12



1676
Strong Box Puller Set

Here's a set of pullers that gives you almost unheard of versatility. You get eight pullers, five attachments, and extra puller jaws. They enable you to pull gears, bearings, pulleys, wheels, and more on cars and light trucks. All these tools are contained in a rugged, lockable metal storage cabinet you can either mount on a wall or stand on a work bench, so they are handy when you need them. Just imagine the jobs you can do with this set!

18886
Storage box only. 29-1/2" wide x 25-3/4" high x 10" deep.

Set No. 1676 consists of:

No.	Description	No.	Description
1026	2/3-jaw puller	7311A	Pitman arm puller
1037	2/3-jaw puller	1122	Bearing splitter
7392	Gear and pulley puller	1123	Bearing splitter
518	Flange-type puller	7372	Rear axle pulling adapter
7403	Steering wheel puller	43888	Long jaws for No. 1026 (3)
1170	Pilot bearing puller		
1177	Slide hammer puller	43892	Long jaws for No. 1037 (3)
		18886	Metal storage box

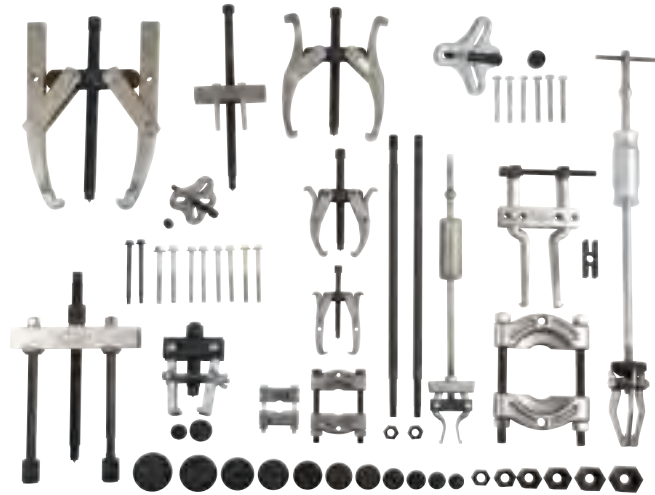

1675
13-Ton Capacity Puller Set

This versatile 13-ton capacity puller set removes gears, bearings, shafts, pinions, bearing outer races, and other tightly fitted parts. The set includes a Push-Puller, Grip-O-Matic® pullers, bearing pulling attachments, specialized pullers, and many accessories. You can work on all makes and models of cars and light trucks with this set.

1620
Board (3' x 4') for storing No. 1675 set (not included with set).

Set No. 1675 consists of:

No.	Description	No.	Description
927	Push-Puller with 6-3/4" legs	7310A	Pitman arm puller
1101	15-3/4" legs for 927 (pair)	8075	Step plate adapter set
1022	2-jaw puller	8035	Internal threaded adapter: 1/2" -20 x 5/8" -18 (2)
1024	2-jaw puller	8044	Internal threaded adapter set
1035	2-jaw puller	1152	Bearing cup pulling attachment
1039	2-jaw puller	1121	Bearing splitter
7392	Gear and pulley puller	1122	Bearing splitter
518	Flange-type puller	1123	Bearing splitter
7403	Steering wheel puller		
1170	Pilot bearing puller		
1176	Slide hammer puller		

Hydraulic Puller Sets

17-1/2, 30-, and 50-Ton Capacity – Individual items in the sets are fully described elsewhere in this catalog. . . consult index.

1688 17-1/2 ton capacity hydraulic puller set

1689 30-ton capacity hydraulic puller set

1690 50-ton capacity hydraulic puller set

No.	Description	1688	1689	1690
HYDRAULICS				
4012A	Single stage hydraulic hand pump assy.	x	x	x
4120A	17-1/2 ton ram with threaded insert	x		
4121A	30-ton ram with threaded insert		x	
4122A	50-ton ram with threaded insert			x
24815	Tee adapter	x	x	x
9650	Pressure gauge	x	x	x
9767	Hydraulic hose – 6 foot	x	x	x
9798	Hose half coupler with dust cap	x	x	x
PULLERS				
1062	17-1/2 ton Push-Puller with 16-1/2" legs	x		
1066	17-1/2 ton 3-jaw hydraulic puller	x		
1070	30-ton hydraulic Push-Puller with 18" legs		x	
1074	30-ton 3-jaw hydraulic puller		x	
1076	50-ton hydraulic Push-Puller with 24" legs			x
1080	50-ton 3-jaw hydraulic puller			x
ACCESSORIES				
1105	Puller leg – 22-1/2"	x		
1111	28" legs for No. 1070		x	
1113	34" legs for No. 1076			x
1127	Bearing pulling attachment		x	x
1130	Bearing pulling attachment	x		
1154	Bearing cup pulling attachment	x		
1166	Bearing cup pulling attachment		x	
201454	Pushing adapter	x		
24814	Speed crank	x		
27198	Speed crank		x	
28228	Pushing adapter	x		
28229	Ram cap		x	
28230	Ram cap for No. 1076			x
29595	Speed crank			x
32118	Ram adjusting screw	x		
32698	Adjusting screw			x
34510	Pushing adapter		x	
34755	Pushing adapter			x
34758	Adjusting screw		x	
41226	2-way head for No. 1074		x	
41224	2-way head for No. 1066	x		
50449	2-way head for No. 1080			x
8020	1"–8 F. x 5/8"–18 M. threaded adapter	x		
8023	1-1/4"–12 F. x 1"–14 M. threaded adapter (2)			x
8028	1-5/8"–5-1/2 F. x 1"–8 M. threaded adapter			x
8029	1-5/8"–5-1/2 F. x 1"–14 M. threaded adapter			x
8036	Female threaded adapter 1"–14 x 1"–14 (2)		x	
8038	Female threaded adapter 5/8"–18 x 3/4"–16 (2)	x		



1688 17-1/2 ton capacity hydraulic puller set



1689 30-ton capacity hydraulic puller set



1690 50-ton capacity hydraulic puller set

HYDRAULIC PULLER SETS PULLERS



Photo for illustrative purposes only. For complete set contents, see chart below. Individual items in the sets are fully described elsewhere in this catalog, consult index.

Hydraulic Puller Sets

- 1679** 17-1/2 ton hydraulic puller set
- 1680** 17-1/2 ton hyd. farm implement service set
- 1681** 17-1/2 ton and 30-ton hydraulic puller set.
- 1682** 17-1/2 ton, 30-ton, & 50-ton master puller set
- 1683** 17-1/2 ton & 50-ton hydraulic construction equipment service set

No.	Description	1679	1680	1681	1682	1683
HYDRAULICS						
4012A	Single-stage hydraulic hand pump assembly	x	x	x	x	x
4008	2-stage hyd. hand pump w/3-way control valve				x	
9650	2-stage hyd. hand pump w/3-way control valve	x	x	x	(2)	x
9798	Hose half coupler with dust cap	x	x	x	(2)	x
9767	Hydraulic hose – 6 ft.	x	x	x	(2)	x
RAMS						
4120A	17-1/2 ton ram with threaded insert	x	x	x	x	x
4121A	30-ton ram with threaded insert			x	x	
4122A	50-ton ram with threaded insert				x	x
PULLERS						
1025	2-jaw puller		x			
1027	5-ton capacity 2/3-jaw puller	x		x	x	x
1035	2-jaw puller		x			
1039	2-jaw puller		x			
1062	17-1/2 ton cap. hyd. Push-Puller w/16-1/2" legs	x	x	x	x	x
1105	22-1/2" legs for No. 1062 (pair)	x	x	x	x	x
1106	9-1/2" legs for No. 1062 (pair)				x	
1107	4-1/2" legs for No. 1062 (pair)				x	
1070	30-ton cap. hyd. Push-Puller with 18" legs			x	x	
1109	8" legs for No. 1070 (pair)				x	
1111	28" legs for No. 1070 (pair)			x	x	
1076	50-ton cap. hyd. Push-Puller with 24" legs				x	x
1113	34" legs for No. 1076 (pair)				x	x
1066	17-1/2 ton 3-jaw Grip-O-Matic® puller	x	x	x	x	x
41224	17-1/2 ton 2-jaw puller head	x	x	x	x	x
1074	30-ton 3-jaw hyd. puller			x	x	
1080	50-ton 3-jaw hyd. puller				x	x
50449	50-ton 2-jaw puller head				x	x
1037	Combination 2/3-jaw puller	x		x	x	x
41226	30-ton 2-jaw puller head			x	x	
43892	Long jaws for No. 1037 (3)			x	x	x
1041	Combination 2/3-jaw puller	x		x	x	x
30902	Long jaws for No. 1041 (3)			x	x	x
1170	Pilot bearing puller		x			
1176	Slide hammer puller		x			
7392	Gear and pulley puller		x			x
24833	Short forcing screw for No. 7392		x			x
Accessories						
8005	5/8"–18 F x 3/8"–16 M threaded adapter (2)	x	x	x	x	x
8006	5/8"–18 F x 1/2"–20 M threaded adapter (2)	x	x	x	x	x
8007	5/8"–18 F x 1/2"–13 M threaded adapter (2)	x	x	x	x	x
8010	5/8"–18 F x 5/8"–11 M threaded adapter (2)	x	x	x	x	x
8013	5/8"–18 F x 3/4"–16 M threaded adapter (2)	x	x	x	x	x
8015	5/8"–18 F x 3/4"–10 M threaded adapter (2)	x	x	x	x	x

No.	Description	1679	1680	1681	1682	1683
8017	5/8"–18 F x 7/8"–14 M threaded adapter (2)	x		x	x	
8018	5/8"–18 F x 7/8"–9 M threaded adapter (2)	x		x	x	
8019	5/8"–18 F x 1"–14 M threaded adapter (2)	x	x	x	x	x
8020	1"–8 F x 5/8"–18 M threaded adapter (1)	x	x	x	x	x
8021	1"–8 F x 1"–14 M threaded adapter (1)	x	x	x	x	x
8012	1"–14 F x 5/8"–18 M threaded adapter (2)			x	x	
8025	1-1/4"–7 F x 5/8"–18 M threaded adapter (2)			x	x	
8027	1-1/4"–7 F x 1"–14 M threaded adapter (2)			x	x	
8023	1-1/4"–12 F x 1"–14 M threaded adapter (2)				x	x
8024	1-1/4"–12 F x 1-3/4"–12 M threaded adapter (2)				x	
8028	1-5/8"–5-1/2 F x 1"–8 M threaded adapter (1)				x	x
8029	1-5/8"–5-1/2 F x 1"–14 M threaded adapter (1)				x	x
8036	1"–14 F x 1"–14 F threaded adapter (2)			x	x	
8038	5/8"–18 F x 3/4"–16 F threaded adapter (2)	(2)	x	(2)	(2)	x
8056	Shaft protector set	x	x	x	x	x
8075	Step plate adapter set	x	x	x	x	x
8076	Step plate adapter set	x	x			
679	Pulley pulling attachment	x		x	x	
680	Pulley pulling attachment			x	x	
8044	Internal threaded adapter set	x	x	x	x	x
10215	Hex nut: 3/4"–16 (2)					x
1154	Bearing cup pulling attachment	x	x	x	x	x
32136	Long jaws for No. 1154 (2)				x	x
1166	Bearing cup pulling attachment			x	x	x
34479	Reducing adapter for use with No. 1166	x	x	x	x	x
1122	Bearing splitter	x	x	x	x	x
1123	Bearing splitter	x	x	x	x	x
1126	Bearing splitter			x	x	x
1127	Bearing splitter				x	x
1128	Bearing splitter				x	
1130	Bearing splitter	x	x	x	x	x
24814	Speed crank	x	x	x	x	x
24815	Tee adapter	x	x	x	x	x
24829	Short bolt (2)					x
24832	Special puller forcing screw	x		x	x	
27198	Speed crank			x	x	
29595	Speed crank					x
28228	Ram cap	x	x	x	x	x
28229	Ram cap			x	x	
28230	Ram cap				x	x
32118	Ram adjusting screw	x	x	x	x	x
32698	Ram adjusting screw	x	x	x	x	x
34758	Ram adjusting screw				x	x
34510	Pushing adapter			x	x	
34755	Pushing adapter				x	x
201923	Pushing adapter	x	x	x	x	x



ENGINE / FUEL / OIL

Oil Filter Wrenches 138
Hose Pliers..... 138
Piston and Valve Tools..... 139
Cam & Timing Tools..... 139 – 140
Engine Testing Tools, Vacuum Test Kit 141

DRIVELINE / TRANSMISSION

Flywheel / Clutch / Primary Tools 142 – 146
Chain / Belt Tools 144
Flange-Type Pullers 145 – 146

CHASSIS / BODY

Steering & Suspension Tools..... 147
Bearing / Body Tools 148

WHEEL / BRAKE

Tire / Brake / Spoke Tools 149 – 150

ELECTRICAL

Battery / Wire / Testing Tools 151 – 152

FASTENERS

Torx® Bits / Allen Wrenches 153

GENERAL

Bushing / Hose / Press / Lift 154 – 158
Torque Wrenches 156
Hammers / Punches / Chisels 156 – 157
Works Lights / Holding Fixture 158



- 4565 Swivel Handle Oil Filter Wrench**
- Fits filters ranging from 2-1/2" to 3-1/8" (64 mm to 80 mm) in diameter.
 - Features a 1" wide stainless steel band for positive grip on the filter; swivel handle makes it easy to turn filters in hard-to-reach areas.



- 4568 Oil Filter Wrench, 2 way, 3 leg**
- Fits filters ranging from 2-1/2" to 5-1/4" (65 mm to 135 mm) in diameter.
 - To turn the tool, use a 1/2" ratchet in the ratchet drive or a 13/16" wrench on the nut.
 - Knurled legs provide extra gripping power.



- 4896 Oil Filter Ring**
- Slim wrench provides clearance around oil coolers and crank position sensor. Use on 14 flute HD filters. 3/8" square drive.

- 6901 Oil Filter Socket**
- Fits Wix oil filters on S&S Engine applications, as well as other filters with 74mm x 15 flutes.



- 6905 Oil Filter Socket**
- Fits Polaris oil filters, as well as other filters with 66.5mm x 14 flutes.



- 4898 Oil Filter Socket**
- Fits Polaris oil filters, as well as other filters with 64mm x 14 flutes. Similar to Polaris No. PU-50105.



- 6906 Oil Filter Wrench**
- For HD Street models as well as other filters with 65mm x 14 flutes. Similar to HD-51453.

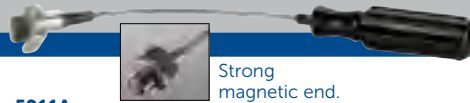

- 5911A Drain Plug PRO**
- The OTC 5911A magnetically attaches to pre-loosened oil pan drain plugs so you can remove them without dropping and avoid getting burned with hot oil.
 - The patented design provides universal application to hex heads. A flexible shaft can be used in virtually any location and still turn the plug as desired.
 - Removable magnetic end with 1/4" square drive. When removed, the drain plug pro becomes a flexible-shaft 1/4" bit driver.
 - Use for sockets and bit holders to get into hard-to-reach places including under dashboards and in engine bays to remove bolts once loosened. Designed for repetitive daily use with a Lifetime warranty.

Strong magnetic end.



- 4848 Flexible Spout Funnel**
- Many oil, transmission, and coolant fluid fill caps are located in hard to access areas. This aluminum 5 1/2" funnel features a removable debris screen in the base flowing to a 25" flexible spout designed to reach these difficult fill locations.

- 4521 Hose Removal Tool**
- Unique tip easily fits between hose and fitting to break stubborn hoses loose.
 - Large handle provides a reliable grip on tool during hose removal.
 - Works on fuel and oil lines – any place a rubber hose is clamped to a fitting.

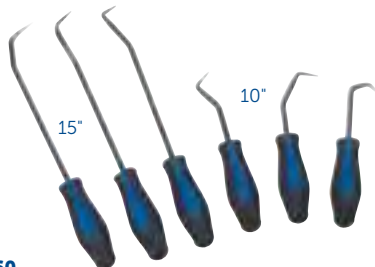
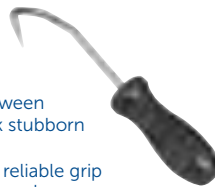

- 8260 Hose Removal Set (6-piece)**
- Consisting of six (6) hose removal tools which consists of three (3) 10", soft-handled tools and three (3) 15", soft-handled tools, each with a hard end-cap.
 - They are made of heat-treated, chrome steel with assorted tip shapes.
 - Ergonomic handle design fits properly in the hand, allowing for easier holding of the tool.
 - Hose removal tools can also be used on upper and lower radiator hoses, clips, washers, gaskets and other items.
 - Packaged in a molded tray.



- 4496 Hose Clamp Pliers Set**
- Contains five different styles of hose clamp pliers, which will service most flat-band and ring-style hose clamps. Also contains a hose removal tool.
- Set Contains:
- Straight hose clamp pliers set
 - Hose removal tool
 - Flat-type hose clamp pliers
 - Offset hose clamp pliers
 - 45° hose clamp pliers

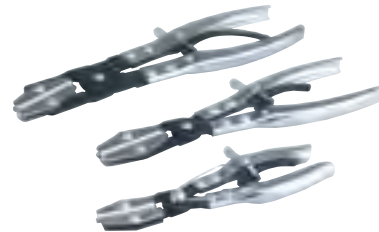

- 4510 Hose Pinch Off Pliers Set, 3 Piece**
- Shuts off flow through vacuum lines, fuel lines, coolant lines, etc.
 - Cocking ratchet mechanism holds pivoting jaws tightly in place. Heavy-duty swivel jaws pivot to assure parallel pinching.
 - Available separately:



- 4522 Vacuum Hose & Fuel Line Removal Tool**
- Designed to remove vacuum hose or fuel lines (3/16" to 1/2") from fittings or tubing.



- 4839 Adjustable Piston Ring Expander Pliers**
- These simple pliers include tips designed to capture the ends of piston rings to hold and expand them securely while installing onto pistons.



4437
8-Piece Sensor Socket Set

Includes:

- 4673-1** 29 mm Vacuum Switch and O2 Socket, 1/2" drive
- 4673-2** 7/8" Vacuum Switch and O2 Socket (wide slot), 3/8" drive
- 4673-3** 27 mm Thermal Sensor Switch, 1/2" drive
- 4673-4** 7/8" Vacuum Switch and O2 Socket (narrow slot), 3/8" drive
- 4673-5** 1-1/16" & 1" Oil Pressure Sending Unit Socket, 3/8" drive
- 4673-6** 7/8" O2 Sensor Socket, offset 1/2" drive
- 4673-7** 7/8" O2 Sensor Socket (low profile), offset 3/8" drive.
- 4437-8** 1-1/16" and 1" Oil Pressure Socket (short access), 3/8" drive



4480
Basic Fuel Injection Service Kit

Performs running, residual, rail and flow rate pressure tests on fuel injected engines. Kit includes adapters, hoses, fittings, and a professional dual scale gauge that reads 0-100 PSI and 0-700 kPa with relief valve. All packaged in a professional, heavy-duty, blow molded carrying case.



7991
Cooling System Pressure Tester

Now you can pressure test the cooling system on motorcycles, ATVs, and even snowmobile applications. The tester's universal fit eliminates the need for multiple adapters.



4842
Heavy Duty Valve Spring Compressor

Used to compress valve springs for removal or installation. The heavy duty C-frame has a 9" opening and a 5" throat. Kit includes 16mm, 19mm, 23mm, 25mm, and 30mm valve spring retainer adapters.

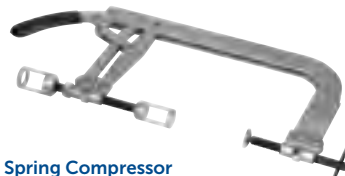

4572
Valve Spring Compressor

- Designed to compress valve springs on overhead valve engines.
- Includes two valve spring adapters, which fit valve spring retainers up to 1" (25 mm) and 1-3/16" (30 mm).
- Unique, direct action compressor lever gives better visibility of valve spring retainers located in difficult access areas.
- Jaw opening of 1-3/8" to 5-5/8" (35 mm to 142 mm); throat clearance of 5-7/8" (150 mm).



Similar to PU-43506-A

7211
Fuel Pressure Gauge Kit

For fuel system diagnosis. It features a sturdy 3-1/2" dial that reads 0-100 psi. It also has a built-in (100-150 psi) retard to prevent excess pressure damage. Check valve to lessen chance of fuel spray.

- Includes 6-ft. bleed hose and 30" pressure hose.
- Bleed valve eliminates air from injection system and can be used to reduce pressure when disconnecting hoses
- Bleed valve also allows gauge assembly to be used to check fuel pump volume.

306905 Optional pressure hose, 70" long.



7602
 Similar to HD-34730-2E

7602
Noid Light

For HD Port Fuel Injection models.



518542
 Similar to PS-48762

518542
Fuel Injection Shradder Fitting

Used for connecting to fuel system for diagnosis.

7361
Fuel Line Disconnects

Disconnect tool designed to fit quick-connect fuel line fasteners. Use to separate fuel lines without damaging the connectors. Tools fit 5/16" and 3/8" lines.

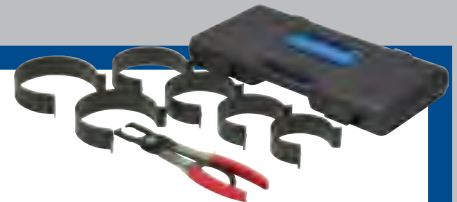

4838
Piston Ring Compressor Set, 6 Piece

This 6 ring set covers 2-7/8" thru 4-3/8" piston diameters. The ring compressor pliers feature a ratcheting lock to hold the handles in position for easy piston installation.



4840
Piston Ring Compressor Set with Ring Expander

This complete set includes 12 chrome plated compressor sleeves covering 1-3/8" thru 4-3/8 diameter piston applications. Both the ring compressor and ring expander pliers feature a ratcheting lock to hold the handles in position for easy piston and ring installation. Complete with a metal carry case.



4875
 Similar to HD-47941



4876
 Similar to HD-42314

Cam/Crank Locking Tool

- Designed to lock the cam and crank sprockets together for removal, replacement and proper torquing of the sprocket bolts.

4875 Application; Dyna 2006 & Later

4876 Application; Twin Cam 88/B 1999 & Later



4844
Cam/Crank Locking Tool, Twin Cam & Dyna

- Designed to lock the cam and crank sprockets together for removal, replacement and proper torquing of the sprocket bolts.
- Double end design covers;
- Twin Cam 88/B 1999 & Later
- Dyna 2006 & Later

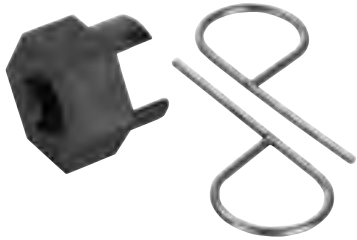

4849
Cam Chain Tensioner Unloader Tool

- These tools are used to unload the pressure of the primary and secondary chain tensioners when servicing HD Twin Cam 88 engines.
- Tools can also be used to check spring loads on chain tensioners.
- Applications include 99-06 FL, 99-05 FXD, 00-06 FXST.
- Similar to HD-42313.



7419
Timing Tensioner Locking Pin Set

- This pin set is used to lock timing belt or chain tensioners once they have been compressed, required during the service procedure.
- Once the belt or chain service is complete, the pin is simply pulled out to return the tensioner to functional.
- 6 pin set with clip to cover most all applications.



4723
Ear Type Clamp Pliers

- Used to crimp the type of clamps used on fuel and cooling system hoses.
- Ensures even, precise crimping, and eliminates possibility of damage to the clamp, boot, or hose.



6589
Electronic Ignition Spark Tester

Use to quickly check spark on 2 and 4 stroke gasoline engines with electronic ignition systems.



4845
Wrist Pin Installer & Remove Tool

- Removes and installs piston wrist pins without having to hold the piston in position and use a drift.
- Applications include HD stock and aftermarket engines, including Twin Cam, and other engine makes with similar piston pin diameter sizes.



4846
Tappet Block Alignment Set

- These adapter screws provide perfect alignment of the oil hole from the crank case to the tappet block on Shovel and Evo style engines.
- Align rocker boxes on Evo heads.
- Also align twin cam oil pump.
- Applications include all HD Big Twin single cam engines, stock and aftermarket, 76 – Present.
- Similar to HD-33443.



4851
Tappet Oil Filter Screen Plug Tool

- A simple tool to remove the tappet oil filter screen plug without removing the exhaust pipes on HD applications. Can also be used on any slot type plug.



4847A
Twin Cam Inner Cam Bearing Remover/Installer Kit

- This kit contains the tools to remove and install inner cam bearings without damage to the crankcase.
- The bearing puller is designed to trap the needle bearings and keep them from falling into the crankcase.
- The installation tools are designed to press on the outer most diameter of the bearing, eliminating damage to the bearing, cam, or case. The press adapter will also set the bearing to its proper depth.
- Removes and installs both 7/8" and 1" ID bearings.
- Similar to HD-42325-B.



4866
Timing Plug

- This threaded clear acrylic timing plug used in conjunction with a timing light allows for viewing the crankshaft timing marks without oil spraying out of the crankcase, typical during full advance RPM.
- Fits all HD models.
- Similar to HD-96295-65D.



4948
Water Pump Drive & Rotor Puller

- Installs the water pump drive gear on the rotor and removes the rotor from the crankshaft. This tool also works on RZR XP.
- Similar to Polaris No. PA-49316.



5604
Motorcycle Compression Tester Kit

Designed specifically for testing motorcycle and small engines, this kit features a specially designed compression gauge and hose assembly, plus three different size hose adapters. Compression Tester and hose lengths are designed for optimal viewing along side engine. Covers most popular motorcycle and small engine plug sizes.

Features and benefits:

- Corrosion resistant nickel plated finish
- 10" flex hose gauge assembly with quick coupler.
- 2-1/2" gauge features chrome bezel and rugged protective outer boot
- Dual scale gauge reads 0-300 psi and 0-2100 kPa
- 12" flex hose -14 mm standard/plus reach (extra length supports V-Twin applications)
- 12" flex hose -12 mm standard reach
- 12" flex hose -10 mm standard reach
- Rugged blow molded hard case with removable lid
- Repair parts kit



5613
Vacuum/Pressure Gauge Kit

Ideal for testing vacuum lines and components. Accurately tests low-pressure fuel systems. Quickly diagnose internal engine problems such as bad rings, valves and leaking head gaskets. Kit comes complete with adapter for most applications. Pin point hard to find problems such as cracked lines.

Features and benefits:

- Large 3-1/2" gauge features a chrome bezel and rugged protective outer boot.
- Dual purpose gauge reads vacuum and pressure.
- Dual scale gauge reads 0-30 in. Hg vac and 0-70 cm Hg, also reads 0-15 psi and 0-100 kPa.
- Built in rear hook allows gauge to be hung at eye level.
- Adapters for most applications.
- Blow molded hard case with removable lid.
- Detailed instruction chart.



5609
Cylinder Leakage Tester Kit

Quickly diagnose internal engine problems such as bad rings, valves and leaking head gaskets. Kit come complete with adapters for most applications.

Features and benefits:

- Dual 2-1/2" gauges feature chrome bezel and rugged protective outer boot.
- Scales read 0-100 psi and 0-700 kPa.
- Pressure regulated manifold includes quick couplers.
- Long flex 24" 14 mm hose.
- 10 mm, 12 mm and 18 mm thread adapters.
- Blow molded hard case with removable lid.
- Detailed instruction chart.



6978
Vacuum Test Kit

OTC 6978 Test-Vac Vacuum Test Kit allows fast, efficient testing and monitoring of many vacuum operated components and also allows one man brake bleeding. The new kit can help find vacuum leaks, test fuel, engine and exhaust valves, door locks, and heating/cooling system performance. Included in the kit are the vacuum pump, fluid container, transfer cap, hoses and fittings, packaged in a convenient blow molded storage case and covered by OTC's Lifetime Warranty.

Includes:

- Vacuum pump with integrated vacuum gauge
- Fluid container with transfer cap
- 2 lengths of vacuum hose
- 12 assorted vacuum hose fittings
- 3 brake bleed fittings
- Instruction Manual
- Blow Molded Storage Case



**4742
Flywheel Puller Kit**

- Developed for many small engines in the ATV, and Motorcycle service markets, these tools are machined from high quality tool grade steel and are packaged in a convenient blow-molded case.
- Each part is marked with size for reference and has a corresponding location in the storage case.
- Works on many makes like Honda, Suzuki, Kawasaki, Yamaha, Ducati and others. For street, performance or off-road.



**4800
Clutch Hub and Alternator Puller**

Removes clutch on Big Twins with 3, 5, and 10 fingers. Also works on Sportster transmission sprocket and clutch. Pulls motor sprockets, alternator covers, and many general pulling applications.

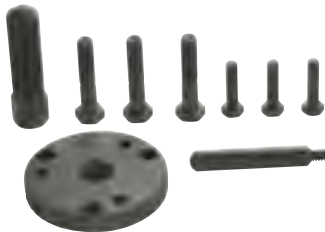

**4850
Flywheel Puller**

Designed to pull magneto flywheel, clutch hubs, or starter gears. Works on wet or dry clutches. 6x25mm and 8x40mm bolts included.



**4860
Transmission & Steering Bearing Puller/Installer Kit**

- This combination kit works on transmission main-shaft and steering stem bearings on HD motorcycles.
- Removes; Fork stem bearings on most applications. Flywheel bearing 00-03 XL. Removes/Installs; Inner bearing race on trans main-shaft Big twin 84 & later.
- Aftermarket trans main-shaft bearings & bushings on 5 & 6 spd. LSD and RSD trans.



**4864-1
Flywheel Puller**

- M33x1.5 RH Internal threads.

Applications

- KTM 625 SMC 2006, 640 LC4 Adventure 04-07, 640 LC4E 2001, 690 RFR 2008
- Suzuki GSXR 1000 01-08, GSXR 600 01-09, GSXR 750 00-08
- Yamaha WR 450F 04-08, YFZ 450 04-09.



**4864-6
Flywheel Puller**

- M38x1.5 RH Internal threads.

- Includes crankshaft protector.

Applications

- Arctic Cat DVX 400 04-07
- Kawasaki KLX & KSF 400 03-06
- Suzuki AN & LT-Z 400 03-07, DR-Z 250 01-07, LTZ 90 2007, LT-Z 250 04-07, LT-F 300F 99-01, DR-Z 400 01-06, DR-Z 400E 00-07, DR-Z 400S 00-06, DR-Z 400SM 05-07, LT-R 450 06-08.



**4864-2
Flywheel Puller**

- M50x1.5 RH Internal threads

- Includes crankshaft protector.

- Fits Suzuki.



**4864-3
Flywheel Puller**

- M24x1.5 RH Internal threads.

- Includes 12mm shaft protector cap.

- Fits Honda, Kawasaki, and Suzuki motorcycle applications.



**4864-4
Flywheel Puller**

- M26x1.0 RH Internal threads.

- Includes 12mm shaft protector cap.

- Fits KTM 4 stroke motorcycles.

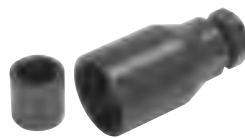

**4864-5
Flywheel Puller**

- M30x1.0RH Internal threads.

- Fits Yamaha WR 250F.

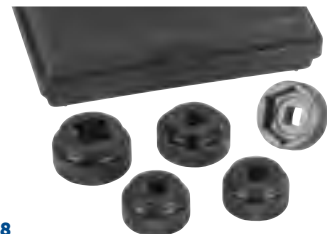

**4888
Flywheel Socket Set**

- The best flywheel sockets available. These offer a low profile design that provides full nut to socket contact to eliminate rounding off the nut and slippage. Made from heat-treated chrome moly steel.

Set includes:

Socket fits pinion shaft nut on big twin 81-89. Size 1-1/4" with 1/2" square drive.

Socket fits crank pin nut on big twins 54 - early 81. Size 1-5/16" with 1/2" square drive.

Socket fits crank pin nut on Sportster 81-99 and Buell 87-99. Can also be used on top fork nut on glide forks. Size 1-3/8" with 1/2" square drive.

Socket fits crank pin nut on big twin 83-99 single cam. Size 1-1/2" with 1/2" square drive.

Socket fits sprocket shaft nuts on big twins 72-99 single cam. Size 1-5/8" with 3/4" square drive.



4970
Heavy Duty Flywheel Puller

- Extremely heavy duty puller to pull the most stubborn flywheels. Includes 2 drive screws and bolts; 8mm x 1.25 x 60mm (3X), 6mm x 1.0 x 55mm (6X), 6mm x 1.0 x 50mm (6X).
- The 6 bolt capable design fits Polaris ATV, Snowmobile, Watercraft and many other makes and models.
- Similar to Polaris No. 2871043-A.

4858
Clutch Spring Compressor Tool

This tool will release the clutch spring pressure for easy removal and installation of the retainer ring. Applications include HD big twin 90-97, and includes spring compressor nut for use on XL 91-05 and Buell.



4992
Clutch Spring Compressor Tool

- This is a required tool for efficient servicing of HD 1340 cc (80 ci) clutches. The compressor relieves spring pressure for disassembly during servicing. Applications include 1340 cc (80 ci) Models 90-97, Buell 95-Later, XL 91-Later.
- Similar to HD-38515-A.

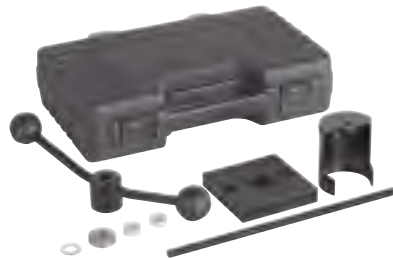

4991
Clutch Compressor Tool

- This universal compressor is used to compress the drive or driven clutch during assembly of disassembly. Innovative design makes use quick and effective without binding. Works on all Polaris and TEAM clutches found on full-sized model ATV, Side x Side, and Snowmobile.
- Similar to Polaris No. PU-50518.



4971
Clutch Holding Wrench

- Designed to hold the drive clutch for retainer bolt removal and torquing. For both P-85 and P-90 drive clutches on Polaris ATV & Side x Side.
- Similar to Polaris 9314177-A.

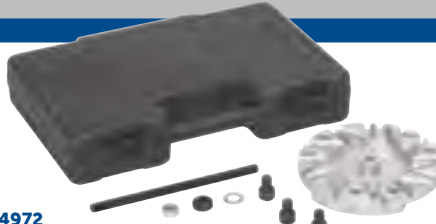

4972
Drive Clutch Holding Fixture

For solid holding of drive clutch for spider removal when shimming for belt-to-sheave clearance or servicing spider.

- Bolt to bench or clamp in a vise.
- Contacts all webs for maximum support to eliminate clutch web damage.
- Center hold down for much greater holding stability while applying off center torque.
- Single person operation, even on the most difficult spiders.
- ATV and Ranger applications.
- Similar to Polaris No. 2871358-B.



4990
Clutch Holding Tool

- Designed to hold the clutch basket while removing or servicing clutch.
- Fits 00-02 Polaris Xpedition models.
- Similar to Polaris PA-44688.



4801
Universal Clutch Holder

Holder arms designed to fit into the external teeth of a clutch hub, but can also be used on gears and sprockets. Opens to handle a 5" OD hub.



4986
Primary Drive Clutch Puller

- Removes primary drive clutches on Polaris ATV & Snowmobile 1985-up (except 400, 500, 600, 700, 800 domestic twins, '99 700 & 800 XCR, '99 Trail RMK, & Supersport 550 Fuji). 3/4" - 16 thread, 10-1/2" long.
- Similar to Polaris 2870506.

4985
Primary Drive Clutch Puller

- Removes primary drive clutches on Polaris ATV Sportsman 600/700 twin EFI X2 02-08.



4984
Secondary Drive Clutch Puller

- Removes secondary drive clutches on Polaris ATV & Side x Side 1985-up. 1" - 12 rolled thread, 5-1/2" total length.
- Similar to Polaris No. 2870913.



4974
Clutch Puller

- Removes drive clutches on Polaris Side x Side and Snowmobile.
- Snow Applications: 700/800 XCR Fuji 3 cylinder engines 1999-2001, all Domestic twin 2 -strokes model year 2000 and newer, FS/FST models 2006 and newer.
- Side x Side Applications: Ranger RZR XP 2011 and newer.
- 3/4-16 thread.
- Similar to Polaris 2872085.



4975
Clutch Puller

- Short puller for removal of the drive clutch from the crankshaft taper on Polaris 550 Sportsman XP 4x4 09-12, 550 Sportsman (all models) 10-12, 570 RZR 4x4 12, 800 RZR 4x4 (all models) 08-12, and Ranger Diesel.
- Similar to Polaris PA-48595.



4978
Clutch Alignment Tool

- Establishes correct clutch offset and alignment on Polaris EBS Clutches.
- Similar to Polaris 2872292.



4979
Clutch Alignment Tool

- Establishes correct 1/2" clutch offset and alignment on Polaris ATV & Side x Side.
- Similar to Polaris 28870654.



4980
Clutch Alignment Tool

- Establishes correct clutch offset and alignment on Polaris P85 Clutches.
- Similar to Polaris 2870426.

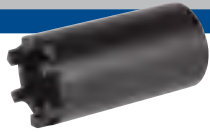

**4987
Clutch Spider Nut Socket**

- Used to remove and install the drive clutch spider jam nut on 2011 & newer Ranger RZR XP. Similar to OE P/N PU-50578.
- Similar to Polaris No. PU-50578.



**4988
Clutch Spider Nut Driver**

- Essential when servicing or re-building Polaris clutch. Fit's P85 and P90 clutches found on Polaris ATVs and snowmobiles 1972 to Present. (except 900 RZR XP 4x4 11-12, 900 RZR XP 4 4x4 12).
- Similar to Polaris No. 2870338.



**4989
Clutch Spider Tool**

- Essential when servicing or re-building Polaris clutch. Fit's P85 and P90 clutches found on Polaris ATV, Side x Side, and snowmobiles 1972 to Present.
- Similar to Polaris No. 2870341.



**4880
4-in-1 Hex Axle Tool**

- Fits internal hex on many late model sport bike axles and some dirt bikes.
- Heavy duty CrMo steel construction for shop use.
- Four metric hex sizes: 17 mm, 19 mm, 22 mm and 24 mm.
- 3/8" square drive on both ends.

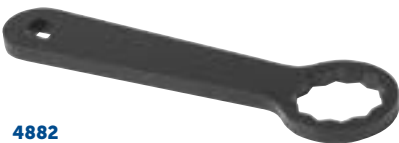

**4882
Rear Axle Wrench**

- This wrench allows for simple adjustment of drive belt tension or rear wheel alignment.
- Eliminates the need to remove any exhaust components.
- 36mm wrench includes a 1/2" square drive allowing for use with a torque wrench for proper axle torque.
- Similar to HD-47925.

**6673
Belt Tension Gauge**

Belt tension gauges are used to properly check drive belt tension on drive belts to ensure maximum belt and bearing life. This belt tension gauge simply connects to the belt to provide the tension reading. Dual scale reads 30–180 lbs. (2.5-15 ft. lbs.) and 130-800 Newtons, covering the 10 ft. lb. spec. typically found on rear drive motorcycle belts.



**4748
Belt Tension Gauge**

This easy to use and read tool allows for accurate belt tension to be set after belt replacement, adjustment, or wheel service. Use on secondary drive belts with a 10 lb. spec. Instructions; 1. Position the small O-ring over the 10 lb. mark. 2. Position the U-shaped belt cradle against the bottom of the belt at a 90 degree angle and locate the large O-ring to a reference point, record reading. 3. Push upward on the rubber bumper until the small O-ring touches the bottom of the tool body. Re-align the large O-ring to the reference point, difference in the reading is the belt deflection (refer to service manual for spec.)



**4745
Chain Master Link Clip Tool**

Designed specifically for roller style chains with specialized tips to easily remove and install master link clips. Includes comfort grip handles.

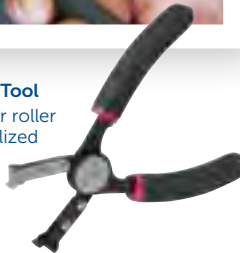

**4746
Chain Master Link Plate Tool**

Tool will remove press-fit master link plates found on many standard and O-ring style roller chains. Will also break 40-60 series chains to add a master link or remove links.



**4744
Chain Breaker and Riveting Tool Kit**

This kit will break, press, and rivet most #25 - #35 and # 428 - #630 standard and O-ring roller chains. Includes HSS rivet tip for riveting hollow nose master links. The hardened steel body has a removable handle for compact storage.



**4738
Chain Breaker & Riveting Tool Kit**

This heavy duty kit makes easy work out of breaking, pressing, and riveting # 415 - # 632 size standard and O-ring chains. The handle can be mounted in 3 different positions on the forged and hardened alloy c-frame, providing access while the chain is on the vehicle. The kit can rivet hollow nose master links as well as hardened pins. Storage case included.



**4739
Chain Brush**

Use to clean and oil various sized roller chains found on motorcycles, ATVs, machinery, etc. Brushes adjust to chain widths ranging from 1/4" to 9/16".

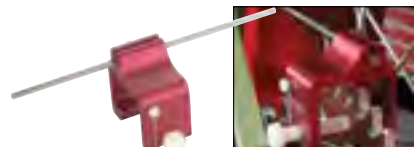

**4749
Chain Alignment Tool**

Designed to simplify the alignment of the countershaft and rear sprocket during chain adjustment or wheel service. Tool clamps to rear sprocket and held with the thumb screw. The rod indicates alignment.

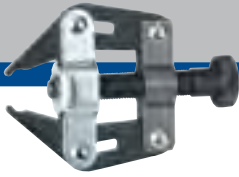

4758
Motorcycle/ATV Chain Tensioner

- Tool is designed to work on drive chains found on motorcycles and all-terrain vehicles (ATVs). Fits the following size chains: 428, 520, 525, 528, and 530.
- Tool jaws fit in chain link ends. Tightening the forcing screw pulls the jaws together to hold the chain for easy removal or installation of the chain connector or master link.



714
Horseshoe Lock Ring Pliers

These pliers feature 8" handles and are designed to spread and remove horseshoe style lock rings found on engines, transmissions, and chassis.



7313
Retaining Ring Pliers

These pliers are 7-3/4" long and are designed to spread and remove retaining rings found on engines, transmissions, and chassis. Maximum spread is 1- 1/16".



4623
CV Joint Banding Tool and Cutter

Use to install and tighten the "band-it" or strap style clamps found on CV joint boots, steering gear boots, or hoses. Tighten the band by turning the handle on the tool; use a socket or wrench on the handle to torque the band to OE specifications. When the boot clamp has been tightened to specs, cut the band to the correct length by flipping the lever (at the front of the tool) forward.



4721
CV Boot Clamp Cutter

Designed to easily cut the CV boot clamp without damaging the boot. Will cut boot clamps up to 10 mm wide and .7 mm thick. Handles are spring loaded to the open position to allow easy access to the clamp.

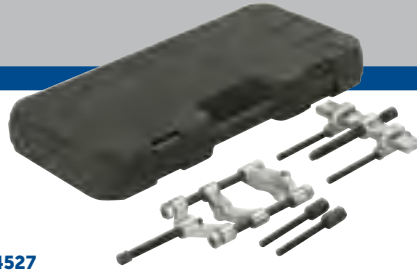

4527
5-Ton Pressure Beam Bearing Splitter Kit

Single point of adjustment allows quick attachment of 3" splitter to the bushing or bearing. Pressure beam is used in conjunction with interchangeable legs. Includes carry case.



7790
Flange Puller Set (48 piece)

Versatile puller capable of removing a wide variety of components having tapped pulling holes such as gears, pulleys, etc.

- Capable of handling 2- or 3-way bolt pulling applications.
- Puller flange: adapts to bolt circle dia. of 1-1/2" to 4-5/8".
- Forcing screw: 5-5/8" lg., 5/8-18 thread.
- Shaft protector: 1-3/16" dia. x 3/4" thick.



525
Flange-Type Puller Combination

Two specialty pullers in one box. You get a flange-type puller for removal of parts with two or three tapped holes. You also get a pulley and flywheel puller. 525 includes: flange-type puller along with a puller with four sets of cap screws.

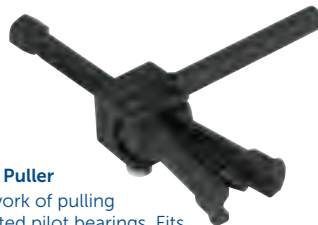

5049
Pilot Bearing Puller

Make quick work of pulling stubborn, rusted pilot bearings. Fits 1" I.D. bearings. The puller's forcing screw expands the jaws inside the bearing and simultaneously pushes against the bottom of the blind hole.



6981
Blind Hole Puller Set

Pilot bearings and pilot bushings are one of the most critical components in a transmission clutch system. Damage, wear, or contamination can result in binding on the input gear and may be revealed as the clutch drag symptoms or even a growling sound when clutch pedal is fully released.

- 5 - collet-actuator combinations cover 5/16" to 1-1/4" I.D.
- Use collets with Pulling Bridge or as Slide Hammer Attachment.
- Easy to read component application chart and instructions.
- Conveniently laid out in rugged blow mold storage case.
- Forged and machined in Owatonna Minnesota, U.S.A

1037
7-Ton Grip-O-Matic Puller

Mechanical Grip-O-Matic® Puller Remove and install parts for fast, effective repairs.

- The puller is forged from quality steel, heat treated, and subjected to rigorous tests which exceed their rated capacity.
- 7-Ton, 2/3-Jaw
- Max. Reach 5" Max. Spread 10-1/2"
- Screw Size 11/16"-18 x 9"
- Jaw Thickness Upper 5/16" Lower 11/32"
- Jaw Width Upper 1" Lower 1"



4532
7-Ton Multi Purpose Bearing and Puller Set

- Offers a bearing/pulley tool solution featuring a classic "H" Bar style puller block accommodating 7" to 11" application spread.
- Comes with 2 sets of forged jaws for a pulling reach range of 5" to 9" – tempered for heavy-duty applications. Two forcing screws are included for short and long pulls.
- Where a Push Puller is the best pulling choice and threaded holes are not available, the 4532 provides technicians and shops with a solution for many applications like side bearings, alternators, generators, power steering and crankshaft pulleys.
- Deep set works excellent for pulling the primary plate from the transmission



**7403
Pulley and Flywheel Puller**

Here's a puller that works in a variety of applications. Works as a regular 2/3-way puller to remove pulleys and small engine flywheels. Cap screws included (pairs): 3/8-16 x 3-1/2 in.; 5/16-18 x 3-1/2 in.; 5/16-24 x 3-1/2 in.; M8-1.25 x 90 mm; and 5/16-18 x 4 in. (SIR).



4518-3



4518-2

**4518
5-Ton Bar-Type Puller/Bearing Separator Set**

- This combination set includes our two most popular bearing 'splitters' (2" and 3"), four sets of hex push-puller legs and a bar-type puller head with a 9/16" forcing screw. Separator tools are used with bar puller and legs for a wide variety of pulling jobs.
- The 5" puller cross-bar with a 6-1/4" forcing screw or each of the bearing separators may also be used separately or in combination with other pullers or tools.
- A blow-molded plastic storage case keeps set contents organized and protected from loss.

Tool No.	Min. Spread	Max. Spread	Tapped Holes	Distance Between Adj. Screws
4518-2	3/16"	2-3/8"	3/8-16	2-3/8"
4518-3	1/2"	2-3/8"	3/8-16	3-9/16"



**4852
Adjustable Primary Locking Bar**

- Used to lock primary for service work.
- Will work on Chain or Belt Drive style primary drives.
- Adjustable length from 4" to 7-1/4" to cover virtually any application.

**6930
Flange-Type Puller Combination**

Heavy-duty flange puller features a live center forcing screw. Includes two live center forcing screw tips and two sets of commonly used automotive bolts. Puller will work on bolt circles from 1-1/2" to 4-1/4". Three cap screws, 3/8-24 x 3" long, and three cap screws, 3/8-16 x 3" long.



**518
Flange Puller**

Pull larger diameter parts having two or three tapped holes.

- Slotted holes in puller body permit cap screws to be positioned to handle bolt circle diameters from 1-1/2" to 4-5/8".
- Three each of two cap screw sizes included: 3/8"-24 x 3" long and 3/8"-16 x 3" long.

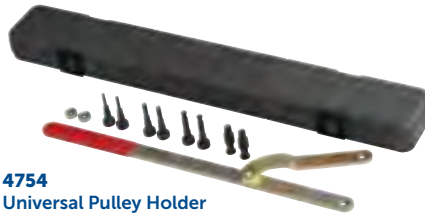

**4754
Universal Pulley Holder**

- Universal design fits many different size pulleys having slots or holes, such as crankshaft / transmission pulleys or gears.
- Wrench is adjustable from 1-1/2" to 8-5/8"; four different size step pins are interchangeable.
- Long handle enables technician to easily hold the pulley when tightening or loosening retaining bolts.



**4802
Universal Pulley Holder Locking Pliers**

This adjustable locking pliers can be used to hold pulleys, clutch hubs, flywheels, gears, and sprockets with internal or external teeth up to a 4" diameter. Can also be used on applications with slots or holes with the 5/16" pins.

**4856
Primary Drive Locking Tool**

- This wedge is placed between the primary chain and motor sprocket to lock them together during removal and installation of the engine sprocket nut without damage.
- Made of POM material to not damage the sprocket or chain.
- Fits all chain primaries.
- Similar to HD-41214.

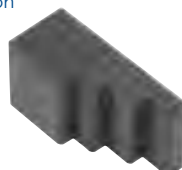

**464
Griplock 2 Ton, 3 Jaw Puller**

Three-in-One "Griplock" Puller is used for general purpose pulling such as hubs, gears, bearings and anywhere this versatile puller can be attached.

- Pressure bearing yoke cap holds jaws in place for ease of set up - in any orientation.
- Yoke arms have two jaw positions and do not require tools to change.
- 2 or 3 jaw applications, with a 3" to 4" spread.
- Both external and internal pulling action.



**465
Griplock 5 Ton, 3 Jaw Puller**

Three-in-One "Griplock" Puller is used for general purpose pulling such as hubs, gears, bearings and anywhere this versatile puller can be attached.

- Pressure bearing yoke cap holds jaws in place for ease of set up - in any orientation.
- Yoke arms have two jaw positions and do not require tools to change.
- 2 or 3 jaw applications, with a 3" to 7" spread.
- Both external and internal pulling action.



**4803
Universal Pulley Holder Locking Pliers Set**

This adjustable locking pliers can be used to hold pulleys, clutch hubs, flywheels, gears, and sprockets with internal or external teeth up to a 4" diameter. Can also be used on applications with slots or holes with the addition of the interchangeable 5, 6, 7, 10, and 16mm pin sets. Complete with metal carry case.



**4804
Heavy Duty Pulley Holder**

This strap style universal wrench features a 9" drop forged handle and 23" leather strap for excellent grip on diameters up to 7". The milled foot increases grip on the strap and pulley as handle force is increased.

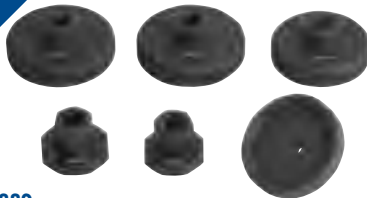

4889 Fork Cap & Compression Valve Socket Set

- This set is designed to fit fork cap sockets or the compression body with an octagonal shape. These offer a low profile design that provides full nut to socket contact to eliminate rounding off the nut and slippage. Made from high quality aluminum and can be driven with the 3/8" square drive or 19mm wrench.



4891 Fork Spring Compressor Kit

- Designed to install fork caps on forks with a large amount of spring pre-load. Kit includes 39mm and 41mm adapter sets, and one jackscrew.
- Application: 39mm and 41mm HD forks.

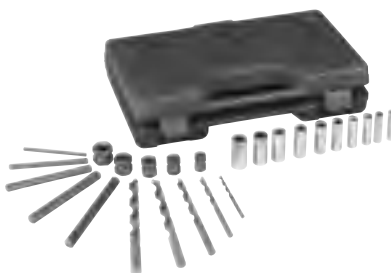

4651 Screw Extractor Set

- Removes broken studs and bolts.
- Includes ten guide bushings, five drill bits and five screw extractors with extractor nuts.
- Drill bits are left handed to help removal.



6939 ATV U-Joint Press

Use to remove and install ATV driveshaft U-Joints.

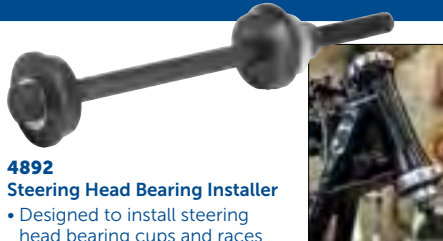

4892 Steering Head Bearing Installer

- Designed to install steering head bearing cups and races completely straight without any damage.
- Will work on stock and custom applications.
- Similar to HD-39302.



4886 Swing Arm Bearing Tool

- Designed to install new needle style bearings into a swing arm. Includes 3 drivers to fit different size bearings. Driver 1 (22.0mm/26.8mm), Driver 2 (21.0mm/26.0mm), Driver 3 (20.0mm/26.0mm).
- Application: For use on late model off-road motorcycles such as Honda, Suzuki, Kawasaki, Yamaha models.



4884 Swing Arm Pivot Bearing Puller

- An essential tool for removing and installing pivot bearings in swing arms and front fenders.
- Applications include HD Softail swingarms 86-Present, HD Springer front fender mounts 97-11.



4968 Swing Arm Tool

- This 2-in-1 tool is designed with one end for removing and installing the pivot bolt lock nut, while the other end will remove the pivot bolt.
- Applications include Honda 4-stroke 4 wheelers.



4964 Ball Joint Service Kit

- Use to remove and install ball joints in vehicle on Sportsman XP, RZR and Ranger models.
- Similar to Polaris No. PU-50506.



4965 ATV Steering Knuckle/Ball Joint Separator

- Eliminates damaging the A-Arm, ball joint stud, or rubber boot while separating the ball joint from the knuckle body. Includes 2 drive bolts for Applications include ATV models Honda TRX and Yamaha YZF, YFZ, and YFM.



4966 ATV Steering Knuckle/Ball Joint Separator

- For removal and installation of lower ball joints on models with pressed-in ball joints on the front strut casting found on Polaris and other Makes.
- Similar to Polaris No. 2870871



4995 Coil Spring Compressor Locking Pliers

- Locking pliers with special jaws that clamp on the external side of the coil spring. Use 2 pliers to evenly compress each side of the spring found on struts and coil over shocks.
- Similar to Polaris No's 2871573 & 2871574.



4517
7-Ton Bar Type Puller/Bearing Separator

- Includes a Bearing Splitter with 4" capacity, two sets of hex push puller legs, a 8" bar type puller head mated with a custom thread forcing screw.
- Puller/Bearing set for tough jobs, up to 7-tons, larger applications, and greater reach 8" to 16".
- Capacity to remove steering stem bearings.



4581
Blind Hole Bearing Puller

- For pulling jobs requiring an internal pull, such as pilot bearings and pinion bushing from cam cover.
- Four collets which fit a wide range of applications. Select the appropriate sized collet by comparing it with the application. Insert the collet, expand it to fit the hole, then attach the slide hammer assembly.

Set includes:

- Four collet sizes: 7/16" to 1/2", 9/16" to 11/16", 5/8" to 1", 1" to 1-1/4" and 2-1/2 pound slide hammer with T-handle and blow-molded plastic storage case.



4797
Steering Stem Bearing Installation Tool

- Provides a quick and easy method to install lower steering stem bearings. The 14" drive tube accepts the 1.0", 1.4", and 1.75" I.D. bearing adapters.



6642
Trim Tool Kit (11 Piece)

- Tools designed to remove specialty body fasteners, trim strips, panels, bezels, liners, shrouds, fascia.
- Tools are constructed of durable, impact-resistant nylon that will not damage metal and non-metal surfaces.



4507
Bearing Driver Set, Stinger

- Permits installation of tapered bearing races and seals without damage to the component or housing. Includes a driver handle plus popular bearing and seal drivers, ranging from 1.565" to 3.180".
- Tapered side of driver is used to install races. Invert the driver to the flat side to install seals. Set is housed in a blow-molded plastic storage case.
- Bearing applications include steering stem, swing arm, and wheel bearings races.



4784
10" Profile Gauge

- This 10" gauge provides an exact copy of a contour or profile needed during bodywork or fabrication. The plastic fingers will not scratch original finish and non-metal surfaces.



4790
Wheel Bearing Removal/Installation Kit

- This tool assembly will remove and install 3/4", 1", and 25mm I.D. sealed wheel bearings.
- Standard wrenches used in combination with tool. Instructions included along with blow molded case.

Includes

- 4790-1** Wheel bearing tool bridge
- 4790-2** Wheel bearing tool screw Ass'ly
- 4790-3** Wheel bearing remover, 3/4"
- 4790-4** Wheel bearing remover, 25mm
- 4790-5** Wheel bearing remover, 1"
- 4790-6** Wheel bearing tool nut/washer
- 4790-7** Wheel bearing forcing screw
- 4790-8** Wheel bearing tool set, 3 piece

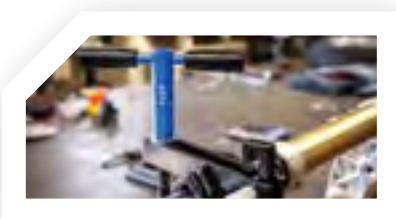

4779
Front Fork & Shock Vice

This vice is designed to hold up to 4" diameter round or oddly shaped components such as forks, shocks, pistons, rods, etc. The V shaped jaws are covered with thick rubber pads to ensure a firm grip without leaving a mark. Comes complete with a table/vice mounting bracket that allows adjustment to any position.



4791
Spanner Wrench, 3/4" - 2"

This chrome vanadium hardened steel wrench features a 5" handle and slim strong hook to access slotted retaining rings in hard to reach areas.



4792
Spanner Wrench, 2" - 4 3/4"

This chrome vanadium hardened steel wrench features a 9" handle and slim strong hook to access slotted retaining rings in hard to reach areas.



7206
Multi-purpose Strap Wrench

You'll find many uses for this heavy-duty strap wrench. The 53" long nylon strap won't mar precision surfaces of shafts, pulleys, or other components. Useful on engine, transmission, and drive pulleys up to 16 inches. Special head design self-tightens the strap as force is applied to the lightweight, 12" long handle.

305085 Replacement Strap.

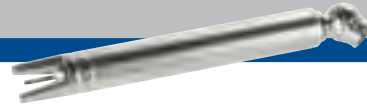

4751
Tire Pressure/Tread Depth Gauge

This 3-in-1 gauge will measure tire pressure, lower tire pressure, and measure tread depth all in one gauge. Rugged cast housing for strength and long life.



4741
Spoke Tool Set (9 Piece)

- Use to tighten or loosen spoke nuts found on most motorcycle and scooter wheel applications.
- Nine interchangeable wrench ends; 5.2 mm, 5.4 mm, 5.6 mm, 5.8 mm, 6.0 mm, 6.2 mm, 6.4 mm, 6.6 mm, 6.8 mm.

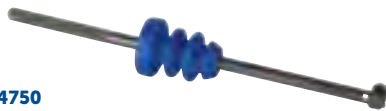

4750
Tire Valve Installer/Remover Tool

This 14" steel tire valve tool includes a stepped rubber sleeve that can be positioned on the handle for optimum pulling angle of the valve, while protecting the wheel finish. Removes and installs snap-in style tire valves.



4769
Wheel Rim Protector Set, (3 piece)

Fits over the wheel rim to protect the wheel from being scratched or damaged while using tire spoons. Set of 3.



4770
Tire Spoon with Grip

This 13" curved tip tire spoon is strong yet comfortable to use with the form fit hand grip. The rounded head prevents puncturing the tube.

4771
Tire Bead Alignment Tool

This aluminum tool will hold a tire bead into the drop center of the wheel when changing the tire or installing an inner tube. The nylon thumbscrew will not damage the wheel finish.



4747
Spoke Torque Wrench Set (22 Piece)

Take the guesswork out of spoke wheel assembly and maintenance. This dual head spoke wrench offers install and removal in one wrench. The click-type torque end applies accurate and equal tension to each spoke, while the fixed end easily removes damaged or rusted spokes. This set includes 11 torque heads and 11 fixed heads for use with the sealed body wrench, all complete in an organizer case. Head sizes included for both ends; 5.0mm, 5.6mm, 5.8mm, 6.0mm, 6.2mm, 6.3mm, 6.5mm, 6.7mm, 6.8mm, 7.1mm, and Spline.



5734-18
Tire Machine Spoon, Double End, 18" Has a curved end and a bent tip end for starting the bead on a tire changing machine.

5734-18G
Tire Machine Spoon, Double End with Grip Grooves, 18" Has a curved end and a bent tip end for starting the bead on a tire changing machine.



5726
Bead Breaking Tool

Designed to break down motorcycle, ATV and small garden tractor tires. The two-tool set includes a locking pliers and pry tool to quickly and easily break the bead. The locking pliers clamps to the wheel rim by forcing the wedged jaw into the tire bead. The pry tool incorporates a second wedge and a loop that quickly hooks to the locking pliers wedge jaw. The pry tool is then pushed down, breaking the tire bead.



5730
Motorcycle Bead Holding Pliers

Specialty locking pliers designed to hold the tire bead either up or down when mounting or demounting a tire. Clamp the non-marring pliers onto the wheel rim and use tire spoons to mount or demount the tire. The pliers eliminate the need to leave a tire spoon in position to hold the tire bead.

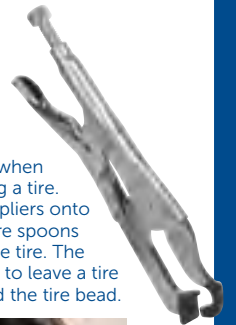

Motorcycle Tire Bead Holding Tool

This tool allows the tire bead to be held in the drop center of the wheel when changing the tire or installing an inner tube. The slot slides over the spoke and the opposite end is depressed to push the tire into position.

4777
For use on wheels with 1 5/8" maximum side profile height.

4775
For use on wheels with 3/4" maximum side profile height.





Brake Fluid Tester

- Tester determines quality of brake fluid.
 - One battery included: 1.5V AAA.
1. Remove cap from brake fluid reservoir.
 2. Remove probe cap from brake fluid tester.
 3. Press power button on top of tester. Green LED lights up.
 4. Dip entire length of metal probes into brake fluid.
 5. After one second, match color of LEDs with color chart to determine brake fluid quality.
- Tester automatically powers off after twelve seconds of inactivity.

4598-DOT3 Tester calibrated with DOT 3 fluid.

4598-DOT4 Tester calibrated with DOT 4 fluid.



6703 Line Fluid Stopper Kit

Stop messy fluid leaks and prevent contamination during service.

- Kit seals all types of rubber and steel line found on fuel, brakes, and oil lines.
- Includes two banjo style fitting stoppers, two steel line stoppers, six line plugs, a line disconnect tool, and a long reach line pinch-off tool for hard-to-reach hoses.

6703-1 Banjo Line Fluid Stoppers, 2 pk

6703-2 Steel Line Fluid Stoppers, 2 pk

6703-3 Line Plug Fluid Stoppers, 6 pk



4740 Spring Hook (6" reach)

- Made from heat treated alloy steel.
- Designed for removing and installing hard-to-reach headlight adjusting springs, exhaust, brake and kickstand springs.



4599 One Man Brake Bleeder Hose

- Removes air from brake system—one wheel at a time— and eliminates the need for an assistant to help do the job.
- Hose easily attaches to bleeder screw, which holds hose in place and prevents leaking.
- Check-valve on end of hose prevents air from entering brake system when pumping brake pedal.

4743 Brake Caliper Spreader

- Compresses the brake pistons on most style calipers for easy pad replacement.
- Fits calipers with 1/4" thick rotor applications, popular on motorcycles.
- Range: .25" (5 mm) to 2.25" (58 mm). Works on all automotive applications in this range.



4799 Brake Piston Removal Locking Pliers

This specially designed locking pliers allows the removal of brake caliper pistons during service or rebuild. The pliers is simply clamped into the I.D. of the caliper piston allowing it to be pulled out of the caliper. Range: 5/8" to 2-1/4" diameter pistons.



4795 Safety Wire Twist Pliers

These versatile 8" pliers will reliably twist safety wire rapidly and consistently. The right hand twist mechanism features an automatic spring return. The forged alloy steel construction features tapered jaws for confined areas and mated cutters to cut safety wire. For use on safety wire applications found on vehicles, machinery, and aircraft.

4796 Steering Neck Bearing Race Remover

Simple way to remove bearing race in the steering neck. Remover is inserted into neck and bolt is adjusted to tighten the remover against I.D. of steering neck. The remover is then driven from other end of neck to remove race. Fits 1-1/8" to 2-5/8" I.D. bearing race.



4794 Safety Wire Drill Guide Set, SAE & Metric Set

Here is the perfect way to drill those nuts and bolts for use with safety wire without breaking the drill bit. These guide, align, and support the hex head or the bolt threads. The hex fixture fits nuts and bolt heads up to 15/16" (24mm). The SAE fixture bar is threaded for 1/4"-20, 5/16"-18, 5/16"-24, 3/8"-18, 3/8"-24, 7/16"-14 bolts, and the Metric fixture bar covers M6x1.0mm, M8x1.0, M8x1.25mm, M10x1.25mm, M10x1.5mm, M12x1.5mm sizes.



8104A Vacuum Brake Bleeder

This one man brake bleeding system allows for fast and efficient vacuum brake bleeding. Universal rubber fitting holds securely on brake bleeder screw. Attach shop air and use the quick release trigger for on-demand vacuum and hands free operation. Compact size and 17 oz. (500ml) capacity.



4870
Master Cylinder Snap-Ring Pliers

Allows for removal of the internal snap rings found in hydraulic master cylinder. Remove and install small to medium snap rings up to a 2 1/8" depth. Other snap ring applications include transmission gear locators, bearing and oil seal retention, and fork seal retaining rings.

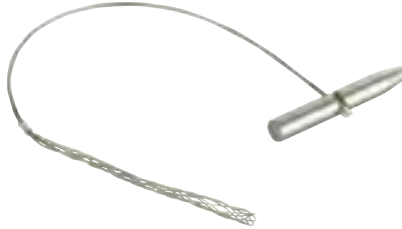

4782
Wire Pulling Tool

This tool contains an 18" cable with a "T" handle at one end and wire mesh at the other. By threading the cable through a difficult to reach area such as a bike frame, wires or connector can be hooked to the end allowing the wiring to be pulled through.



4878
Ignition Switch Housing Alignment Tool

- This tool aligns the ignition switch housing properly as the retaining screws are being torqued. Proper switch alignment extends the life of the ignition switch. Applications include HD FL Touring models 03 – Present, V-Rods 02 – Present.
- Similar to HD-45962.



4617
Terminal Battery Brush

- Designed to clean corrosion from side post batteries.
- One brush used to clean battery terminals; other brush used to clean battery cable ends.
- Plastic handle resists battery acid.



4813
Heat Shrink Tubing Set (171 Piece)

Protection and insulation for solder connections and components. 2 to 1 shrink ratio with flame or heat gun.



4614
Battery Terminal Wrench, 5/16, 6 pt.

- Designed for use on side-terminal batteries, or any 5/16" hex head battery bolt.
- 5/16", 6 point, box end, 5-1/2" long, ratcheting wrench; insulated handle.

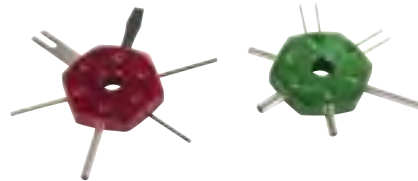

4822
Wire Connector Tool Set (2 Piece)

Designed to remove terminals from connector housing without damage to the terminal or connector. Set provides 12 different tool styles fit most common connectors.



4814
Waterproof Heat Shrink Tubing Set (106 Piece)

Waterproof protection and insulation on solder connections and components. Adhesive lined inner wall to seal out moisture. 3 to 1 shrink ratio with flame or heat gun.



4616
Battery Terminal Wrench, 10mm, 12 pt.

- Designed for use on 10 mm battery terminal bolts found on many batteries.
- 10 mm, 12 pt., box-end ratcheting wrench; 5-1/2" long with insulated handle.



4461 Terminal Release Tool Set

- Save time and money. Repair or rebuild a wiring harness without having to order the entire OE replacement.
- Services most OE terminal connectors. Insert the appropriate release tool to depress the locking tab and the individual wire slides out for service or replacement.

Kit includes:

- 7737 Computer edge board and header release tool.** Each end of the tool works on different terminal connector configurations. Works on various domestic and import models.
- 7738 Weather Pack sensor terminal release tool.** Works on various domestic and import models.
- 7740 Micro-style terminal release tool.** Works on various domestic and import models.
- 7741** Specifically designed to release ID computer terminals on various domestic and import models.
- 7742 Universal harness release tool** designed to work on various domestic and import models.
- 7743** Releases terminals on most harness connectors on various domestic and import models, including water, O₂, vacuum, and air temperature sensors.



4467 Automatic Wire Stripper

- Quick removal of insulation on wire AWG 12-20.
- Comes with adjustable depth gauge (8mm to 12mm).
- Sharp v-shaped tooth easily removes insulation without any damage to soft wire strands.
- Cutting tool stored below the stripper.
- Features a space saving locking mechanism for pockets or tool drawer storage.



5912 Crimpwell™ Angled Crimping Pliers

- Universal crimping design accommodates soft wire – solid or stranded – 10-22 AWG.
- Cutting feature included for quicker preparation.
- 9" (228mm) in length, with protective grips to increase leverage and secure crimp.
- Angled design keeps the connector, the wire, and the crimper "in-line" – improving visibility and access in hard to reach places.
- Designed to not pierce connector insulation and also works on un-insulated connectors.
- Service tech can use as much force as desired to ensure connection and it will not damage connector insulation.
- Easy-to-use: Simply insert the connector into the crimping feature, slip over the connector and squeeze.



5953 Dual End Wire Holder

- Holds wire and connectors solidly during soldering or other wire service.
- Unique design allows connection to be held firmly on both sides with infinite adjustability.
- Insulated clips act as heat sinks to protect shrink tubing or other sensitive parts from heat.



5955 Magnetic Clamp Wire Holder

- Holds wire and connectors solidly during soldering or other wire service.
- Unique design allows connection to be held firmly on both sides with infinite adjustability.
- Insulated clips act as heat sinks to protect shrink tubing or other sensitive parts from heat.
- Clamp with magnet allows for attachment to a work bench, vehicle, or any other object for a firm base.



5950K CrimPro™ 4-in-1 Wire Service Set

CrimPro™ 4-in-1 Wire Service Set includes both the OTC 5950S CrimPro™ 4-in-1 Wire Tool and OTC 5950A CrimPro™ 4-in-1 Angled Wire Tool.

5950S

- Compact 7-inch design used 4 ways.
- Gripping nose - to pull, twist, bend, and shape.
- Crimper - crimps 12-20 AWG insulated and non-insulated wire.
- Stripper - strips 12-20 AWG wire.
- Cutter - ability to make cuts below pivot.

5950A

- The angled feature allows access to close quarters and facilitates superior crimps.
- Compact 7-inch design used 4 ways.
- Gripping nose - to pull, twist, bend, and shape.
- Crimper - crimps 12-20 AWG insulated and non-insulated wire.
- Stripper - strips 12-20 AWG wire.
- Cutter - ability to make cuts below pivot.



4783 Flexible Magnetic/Claw Pick Up Tool

The 25" flexible spring shaft allows the tool to reach difficult areas and pick up objects either magnetically or with the use of the retractable claw.



4818 Multi-Purpose Scissors

Will cut hose, wire and cables, wood dowel, PVC, and thin sheet metals in addition to general cutting. The hardened stainless steel blades have an angle ground into one that eliminates slipping when cutting round materials.



5900A-PLUS
Master Torx Bit Socket Set, 53-piece

Updated 53-piece Master Torx Bit Socket Set plus special 24mm External Torx PLUS Socket (p/n 5932-24) required for Ford Super Duty pick-up beds starting model year 2017. Socket kit includes various sizes of Torx, Torx PLUS, Tamper Resistant Torx, Bit Sockets and External Torx Sockets in 1/4", 3/8" and 1/2" square drive. Stored in a convenient hard plastic clamshell case for protection and organization. Not rated for use with impact tools.

6100
Standard TORX® Socket Set
T10 to T60 (12 piece)

Set includes one each of the following:

No.	Size	Sq. Drive
6101	T10	1/4"
6102	T15	1/4"
6103	T20	1/4"
6104	T25	1/4"
6105	T27	1/4"
6106	T30	1/4"
6107	T40	3/8"
6108	T45	3/8"
6109	T47	3/8"
6110	T50	3/8"
6111	T55	3/8"
6112	T60	1/2"



6150
External TORX®
Socket Set (7 piece)

Set includes one each of the following:

No.	Size	Sq. Drive
6151	E6 x 25	1/4"
6152	E7 x 25	1/4"
6153	E8 x 25	1/4"
6154	E10 x 32	3/8"
6155	E12 x 32	3/8"
6156	E14 x 32	3/8"
6157	E16 x 32	3/8"



6170
Metric Hex Socket Set
(7 piece)

Set includes one each of the following:

No.	Size	Sq. Drive
6171	3 mm	3/8"
6172	4 mm	3/8"
6173	5 mm	3/8"
6174	6 mm	3/8"
6175	7 mm	3/8"
6176	8 mm	3/8"
6177	10 mm	3/8"



6180
TORX® PlusSocket Set
(9 piece)

Set includes one each of the following:

No.	Size	Sq. Drive
6181	TP10	1/4"
6182	TP15	1/4"
6183	TP20	1/4"
6184	TP25	1/4"
6185	TP27	1/4"
6186	TP30	1/4"
6187	TP40	3/8"
6188	TP45	3/8"
6191	TP50	3/8"



5933
MortorQ® Super Bit Set
(5-piece)

Set includes one each of the following:

No.	Size	Sq. Drive
5933-0	MTS 0	3/8"
5933-1	MTS 1	3/8"
5933-2	MTS 2	3/8"
5933-3	MTS 3	3/8"
5933-4	MTS 4	3/8"



4780
Personal Tool Pack

Includes 1/4" drive ratchet, 2" extension, 16 drive bits, and Universal Spline sockets fit both SAE 3/16" - 9/16" and metric 5mm - 14mm nuts and bolts in a variety of styles; 6 pt., 12 pt., torx, square, spline, etc. All tools included in a travel pouch.



5943
9-Piece Power Driver Socket Extensions

The 5943, 9 piece Power Driver Socket Extension set from OTC adds versatility to your existing power tools and socket sets. Each extension uses a 1/4" hex shank for adjustable chuck drills with 1/4", 3/8" or 1/2" square drive on the other end for sockets. 3 square drive sizes - 1/4", 3/8" and 1/2" and 3 lengths for each - 2", 6" and 12". Now use your sockets with your cordless power tools for short, medium and long reach applications. The 5943 is a great choice for running up multiple bolts like oil and transmission pans or rear ends instead of ratcheting each one by hand. Save your time for proper torqueing instead of hand turning your bolts. Limited lifetime warranty.

- 5943-1** Three 1/2" square drive socket extensions in 2", 6" and 12" lengths
- 5943-2** Three 3/8" square drive socket extensions in 2", 6" and 12" lengths
- 5943-3** Three 1/4" square drive socket extensions in 2", 6" and 12" lengths



5180
Portable Multi Purpose C-Frame Press

- Lightweight (less than 28 lbs.) and durable, the 5180 portable press is perfect for bench top pressing applications.
- Use for all clamping, pressing, and bending needs. Ideal for welding and metal fabrication.
- Press can be positioned vertically or horizontally.
- Versatile 9" - 4-1/4" Open-Throat® design.
- Couples to any 4- or 10-ton Porta Power pump.
- Base allows the operator to mount the press to a bench.

Set includes: C-Frame press with base, adapters: V-pushing and ram pushing (9/16" and 3/4" dia. shanks), receiving inserts, flat insert, storage case.



**4781
Super Stubby Screwdriver Set**

These screwdrivers are perfect for those limited access fasteners typically found on carburetors or in electrical compartments and many other areas.

- 2 Phillips and 2 straight screwdrivers included in set.



**8262
Short Pick & Hook Set (4 Piece)**

Consisting of four (4), 6.5", soft-handled picks.

- They are sturdy, with both stainless steel shafts and tips, with assorted tip shapes designed for marking, removing O-rings, accessing snap rings and other assorted applications.
- Ergonomic handle design fits properly in the hand, allowing for easier holding of the tool.
- Multi-use tools to scribe, align pierce, clean or remove O-rings, shaft seals, CV boot and motorcycle fork seals and dust hoods.
- Packaged in a molded tray which can be placed in tool drawer.



**8263
Long Pick & Hook Set (4 Piece)**

Consisting of four (4), 9.25", soft-handled picks.

- They are sturdy, with both stainless steel shafts and tips, with assorted tip shapes designed for marking, removing O-rings, accessing snap rings and other assorted applications.
- Ergonomic handle design fits properly in the hand, allowing for easier holding of the tool.
- Multi-use tools to scribe, align pierce, clean or remove O-rings, shaft seals, CV boot and motorcycle fork seals and dust hoods.
- Includes a knurled shaft which allows good grip with grease or oil on hands.
- Packaged in a molded tray which can be placed in tool drawer.

Tool No.	Size
7011-1	.375" 10 mm
7011-2	.500" 13 mm
7011-3	.625" 16 mm
7011-4	.750" 19 mm
7011-5	.875" 22 mm
7011-6	1.00" 25 mm
7011-8	1.25" 32 mm
7011-10	1.50" 38 mm
7011-12	1.75" 44 mm
7011-14	2.00" 51 mm

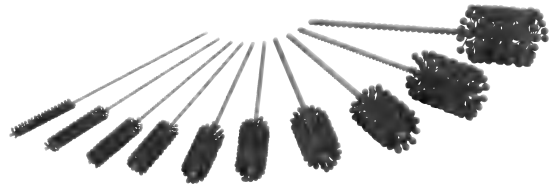

**7011
Ball Hone Set (10 piece)**

- Ball Hones can be used for refinishing and resizing bores such as found in brake calipers, engine lifters, and u-joint yokes. Also useful for any bearing or bushing application.
- All hones are 180 grit Silicone Carbide for excellent cutting and finish.



**4786
Aluminum Vice Inserts**

Essential for every workbench vice. Aluminum jaws have reliefs for 5/16, 3/8, & 9/16 (7mm, 10mm, & 15mm) diameter shafts. Excellent for holding steel shafts without scratching or damage such as shocks, crankshafts, or any threaded bolts and shafts.

**8203S
3-Piece Short Handled Pry Bar Set**

A 3-piece Handled Pry Bar Set that includes 8", 12" and 18" lengths for moving or separating components with maximum leverage. Each bar is made from tempered square steel for durability and strength. The dual durometer handle provides a comfortable and secure grip, reducing hand fatigue. A black chrome striking cap will take hammer blows without handle damage, and a polished tip and black oxide finish resists rust and wear during use. Covered by OTC's Lifetime Warranty.



- 8208** 8" handled pry bar
- 8212** 12" handled pry bar
- 8218** 18" handled pry bar



**8203L
3-piece Long Handled Pry Bar Set**

A set of 3 made-in-the-USA pry bars with comfortable, sturdy rubberized grips. Each bar is drop-forged in Minnesota with a hand-ground chisel end for wedging into tight spaces. Special tempered steel provides extra strength, durability and leverage for tough jobs. A dedicated striking cap provides a big target to drive the pry bar in to help separate components faster. Includes lifetime warranty.

- 8224** 24" handled pry bar
- 8236** 36" handled pry bar
- 8248** 48" handled pry bar



**4410
Master Bushing Driver Set**

- Enables you to remove and install bushings ranging from 10mm to 42mm in diameter, and 3/8" to 1-3/8" in diameter.
- Includes large, medium, and small driver shafts and adapters all made of steel.
- Housed in a blow-molded storage case.



4484
Weatherpack Crimper Set

Manage environmentally-sealed connection systems with the OTC 4484 Weather Pack Crimper Kit. Weather pack connection systems are designed to protect against exposure to heat, moisture and contaminants. Includes:

- Two interchangeable crimping dies coverage wire range AWG 22 / 20-18 (DIN: 0.35 / 0.5-0.8mm) and AWG 16-14 / 12 (DIN: 1.0-2.0 / 3.0mm).
- Dies are magnetically secure and easily changed.
- Instructions clearly illustrate how to create a weather-proof seal.
- Connections found on motorcycles, Class 7 - 8 tractors, automobiles and more.

- 4484-1** Ratcheting Crimper Chassis
- 4484-2** Weather Pack Crimp Die Set
- 4484-3** Weather Pack Crimp Die Set



4497A
Ratcheting Terminal Crimper

- Heavy-gauge steel crimping tool designed for insulated wire terminals.
- Ratcheting action crimps terminal to correct tightness on the wire, making crimping fast and easy.
- Insulated handles with compound mechanical leverage for power.
- For wire sizes: AWG 22-18 (0.6mm—1.0mm) red terminal; AWG 16-14 (1.3mm—1.6mm) blue terminal; AWG 12-10 (2.0mm—2.6mm) yellow terminal.



4512
Snap Ring Pliers Set – Internal/External

- For internal or external snap rings; thumbscrew permits quick conversion.
- Made of heavy-gauge tempered steel.
- Includes two stainless steel handled picks.
- Contained in a blow-molded plastic storage case.



4411
Ratcheting Hose & PVC Cutter (Standard)

- Cuts hose and PVC up to 1-3/8" dia.
- Features metal frame and ergonomic handles for high leverage.
- Compound ratcheting action provides maximum cutting power.
- Will also cut cable and wires.



4412
Ratcheting Hose & PVC Cutter (Heavy Duty)

- Cuts hose and PVC up to 1-3/4" dia.
- Features metal frame and rubber padded ergonomic handles for high leverage and comfort.
- Compound ratcheting action provides maximum cutting power.
- Will also cut cable and wires.



4509
Straight-Blade Hose Cutter

- Cuts rubber hoses ranging from 1/4" to 1-1/2".
- Simply place hose in tool and squeeze handle to cut.
- Replacement steel cutter blade No. 4509-1 is available.

4509-1
 Replacement hose cutter blade

No. 4512 includes:

Tool No.	Description
4512-1	.090" tip, straight pliers
4512-2	.090" tip, 90° pliers
4512-3	.070" tip, straight pliers
4512-4	.070" tip, 90° pliers
4512-5	.047" tip, straight pliers
4512-6	.047" tip, 90° pliers
4512-7	.038" tip, straight pliers
4512-8	.038" tip, 90° pliers
4512-9	straight tip pick
4512-10	90° tip pick

All items can be purchased separately.



1545
Motorcycle/ATV Lift

- 1,500 lb. capacity and 17" long skids that will lift the largest, widest cruisers.
- Lowest clearance available, 3-1/2" at lowest level, with a wide lift range of 3-1/2" to 16-3/4".
- Removable handle provides 360° access to load.
- Features also include foot pedal release, locking rear casters, automatic safety lock, and two ratcheting tie down straps for safety.



4490
Magnetic Tray

- Rectangular, stainless steel tray is 9-1/2" x 5-1/2" and 1-1/4" deep. Holds tools and small metal parts so they don't get lost or misplaced during repair work.
- Two heavy-duty magnets on bottom of tray have non-marring contact pads; will securely hold tray to metal objects such as a tool box, frame rail, fender, etc.



4515
Mini Pick and Hook Set – 4-Piece

- Sturdy stainless steel points and shafts designed for marking, removing o-rings, accessing snap rings, and performing other tasks. Assorted angle tips allow you to reach awkward locations.
- Knurled shaft design enhances finger control for delicate jobs.

Accutorq™ Klikker Torque Wrenches

These precision torque wrenches make a loud click when you've reached the torque setting. They feature ratcheting heads, all-metal construction, permanently roll-marked scales, and soft-grip rubber handles that enable you to firmly grasp the wrench for right- or left-hand torquing.

- Includes molded plastic case.
- One-year warranty.



7375



**7380-E150
Digital Torque Wrench**

- Displays torque in real time and at peak when torque is released.
- Torque value accuracy is $\pm 1\%$ clockwise (CW) and counterclockwise (CCW) from 10%–100% of full scale.
- Can be used to measure bearing preload torque values.
- Display starts at 1% to 250% of full scale; has a 5-digit, alpha-numeric LCD, and indicator icons for functions, units and battery.
- Indicators include green, yellow and red LED light, an audible buzzer, and vibration.
- 1/4" Drive, 36 tooth ratchet head. Range 1.5 – 150 In Lb.



7377

Tool No.	Torque Range	Graduations	Square Drive	Length
7375	100-1000 in.-lb (11-113 N•m)	10 in.-lb	3/8"	15-1/8"
7377	10-150 ft.-lb (14-203 N•m)	2 ft.-lb	1/2"	17-3/4"



**4629
Brass Hammer and Punch Set**

- Brass-head hammer and punches are ideal to use where sparks from ferrous metals would be hazardous, or where precision metal parts could be damaged by steel tools.
- Two hammer head weighing 24 and 12 oz.
- Two tapered punches 14" x 5/8", 10" x 5/8".
- One hex tapered punch 8" x 5/8".
- Two drift punches 10" x 3/4", 8" x 1/2".
- Two pin punches 6" x 3/8", 4" x 1/4".



**4606
Brass Hammer and Punch Set**

- Brass-head hammer and punches are ideal to use where sparks from ferrous metals would be hazardous, or where precision metal parts could be damaged by steel tools.
- Hammer head weighs 24 oz.; brass drift punch is 10" x 3/4" diameter; brass tapered punch is 8" x 5/8" hex tapered to 3/8" diameter point.



**4602
Brass Punch Set (2 piece)**

- Two large, brass non-sparking punches. Ideal for use near precision parts or in locations where sparks from ferrous metal could be hazardous.
- Includes an 8" punch (5/8" hex, tapered to 3/8") and 10" straight punch (3/4" dia., chamfered at both ends).



Rolling Head Pry Bars

You'll have a lot of leverage using one of these rolling head pry bars. The long, tapered body will also serve as an aligning drift.

7163 Pry bar; 12" long.

7165 Pry bar; 18" long.



**4550
Scraper Set**

Scrapers feature polished, heat-treated, stiff, stainless steel blades. Handles are ergonomic two-component plastic and feature a non-slip grip and steel bolstered end. Packaged in a storage tray. Includes: 1-1/4" straight blade, 1-1/4" bent blade, and 2" straight blade tips.



4605
Interchangeable Punch and Chisel Set

- Safety protective handle allows easy grip and protects hand from being hit by hammer.
 - 12 punches and chisels included: 5 flat chisels: 1/2", 5/8", 3/4", 7/8", and 1" wide blades 1 cape chisel: 1/4" wide blade 2 taper punches: 1/8" and 1/4" diameter 2 pin punches: 3/16" and 1/4" diameter 2 center punches: 1/8" and 3/16" diameter
 - Double locking ball detent holds punch or chisel securely in the driver handle.
- Replacement parts available:

- 4605-1** Drive handle
- 4605-2** 1/2" wide flat chisel
- 4605-3** 5/8" wide flat chisel
- 4605-4** 3/4" wide flat chisel
- 4605-5** 7/8" wide flat chisel
- 4605-6** 1" wide flat chisel
- 4605-7** 1/4" cape chisel
- 4605-8** 1/8" taper punch
- 4605-9** 1/4" taper punch
- 4605-10** 3/16" pin punch
- 4605-11** 1/4" pin punch
- 4605-12** 1/8" center punch
- 4605-13** 3/16" center punch



Impact Drivers

- Loosens hard-to-turn screws, bolts or nuts.
- Handle design prevents possibility of hitting hand with hammer when striking impact driver.
- Bit holder has 3/8" drive (No. 4608), 1/2" (No. 4607) drive, and 5/16" hex for Phillips and flat screwdriver bits.
- Includes eight screwdriver bits:
 - No. 2 Phillips bit, 1-3/8" long with 5/16" hex
 - No. 2 Phillips bit, 3-1/8" long with 5/16" hex
 - No. 3 Phillips bit, 1-3/8" long with 5/16" hex
 - No. 3 Phillips bit, 3-1/8" long with 5/16" hex
 - 5/16" wide x 1-3/8" long with 5/16" hex slotted bit
 - 5/16" wide x 3-1/8" long with 5/16" hex slotted bit
 - 3/8" wide x 1-3/8" long with 5/16" hex slotted bit
 - 3/8" wide x 3-1/8" long with 5/16" hex slotted bit

- 4607** 1/2" impact driver.
- 4608** 3/8" impact driver.

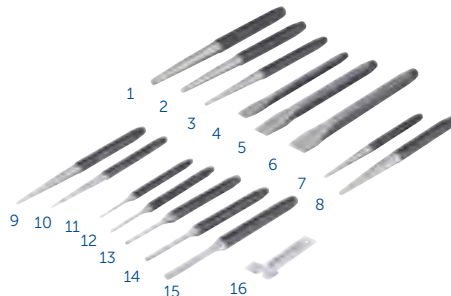

4600
Punch and Chisel Set (16 piece)

- Durable set of heat-treated chrome vanadium steel punches and chisels. Storage tray included.
- Contents of set:
 - 3 – Cold chisels (with gauge): 3/8" x 5-1/2"; 1/2" x 6"; 5/8" x 6-1/2"
 - 2 – Center punches: 1/8" x 5"; 3/16" x 6"
 - 5 – Pin punches: 3/32" x 4-1/4"; 1/8" x 4-3/4"; 5/32" x 5"; 3/16" x 5-1/4"; 1/4" x 5-3/4"
 - 5 – Taper punches: 3/32" x 5-1/4"; 1/8" x 5-3/4"; 5/32" x 6"; 3/16" x 6-1/4"; 1/4" x 6-3/4"
 - 1 – Chisel gauge



4576
Universal C-Frame Nut Splitter

- Forged and heat-treated frame with offset handle works where ordinary nut splitters may fail. Smooth action cracks nuts without damaging bolt threads.
- Chisel rotates to line up parallel to bolt. Splits non-heat-treated nuts of 7/16" (11mm) through 3/4" (19mm) diameter. Tool is 6-3/4" in length.



4514
Mini Snap Ring Pliers Set (4 Piece)

- Small-size pliers for work in tight areas. Service S-ring and R-ring clips, internal or external, straight or angled. Ruggedly built of heat-treated chrome molybdenum steel.
- Set includes two internal snap ring pliers (one straight, one 45°) and two external snap right pliers (one straight, one 45°).
- All pliers have .038" (1.0mm) diameter tips.

No.	Part No.	Description
1	4600-15	Taper Punch, 1/4" x 6-3/4"
2	4600-14	Taper Punch, 3/16" x 6-1/4"
3	4600-13	Taper Punch, 5/32" x 6"
4	4600-3	Cold Chisel, 3/8" x 5-1/2"
5	4600-2	Cold Chisel, 1/2" x 6"
6	4600-1	Cold Chisel, 5/8" x 6-1/2"
7	4600-4	Center Punch, 3/16" x 8"
8	4600-5	Center Punch, 1/8" x 5"
9	4600-12	Taper Punch, 1/8" x 5-3/4"
10	4600-11	Taper Punch, 3/32" x 5-1/4"
11	4600-10	Pin Punch, 3/32" x 4-1/4"
12	4600-9	Pin Punch, 1/8" x 4-3/4"
13	4600-8	Pin Punch, 5/32" x 5"
14	4600-7	Pin Punch, 3/16" x 5-1/4"
15	4600-6	Pin Punch, 1/4" x 5-3/4"
16	4600-16	Chisel Gauge



6613
Variable Pin Spanner Wrench

- Universal design fits many different types of pulleys having slots or holes, including camshaft pulleys and crankshaft pulleys.
- Wrench is adjustable from 1-1/4 inch to 5 inches; works with a 1/2 inch ratchet or breaker bar.

Set Includes:

- 526908-1** 3.5 mm pin
- 526908-2** 4 mm pin
- 526908-3** 4.5 mm pin
- 526908-4** 5 mm pin
- 526908-5** 6 mm pin
- 526908-6** 7 mm pin
- 526908-7** 10 mm pin
- 526908-8** Handle



**4650
Mirror and Magnet Set**

- Handles telescope from 6-1/2" to 25". Swivel heads allow access to tight areas.
- Large, rectangular swivel mirror is 2" x 3-1/2", and is attached to one telescoping handle; small mirror is 1-1/4" in diameter, and is interchangeable with magnets on the other handle.
- Magnets can lift up to 8 lbs.

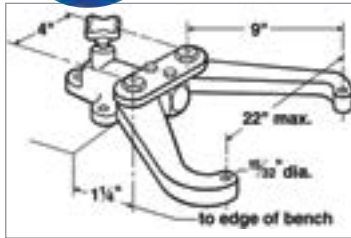

**7020
Bench-Mounted Holding Fixture**

Securely hold and rotate small engines, transmissions, and other components while you're working on them.

- This holding fixture will handle pieces weighing up to 250 lbs., and it offers 360° of rotation with positive stops at 90° increments.
- Three sides of the mounted unit remain fully exposed.



34607 Base assembly only.



Universal Outside Thread Chaser

This thread chaser will quickly restore threads on fork tubes, steering stems, axles, etc. to near original condition without the use of expensive thread-cutting equipment.

- Replaceable V-pads and dies.
- 1-1/4" to 5" O.D.

**7402
Thread chaser with 6 dies:** threads per inch - 4, 5, 6, 7, 7-1/2, 8, 9, 10, 11, 11-1/2, 12, 14, 16, 18, 20, and 24.

**216884
Standard die set.** Includes 6 dies, in the sizes listed above.

**202817
Metric die set.** Includes three dies: 1 mm- 1.25 mm-1.5 mm-1.75 mm, 2 mm-2.5 mm-3.0 mm-3.5 mm; 4 mm pitch dies.

**206803
V-pad**



**FOR PRODUCT
VIDEOS VISIT
OTCTOOLS.COM**



**5550
Spectrum Solar10W
LED Work Light with
UV Top Light**

5550 Specifications

10W LED Work light with UV Top Light
LI-ION Rechargeable Battery – 3.6V 2250 mAh, AC/DC
Charger Input AC 100 ~ 240V; 50/60Hz; DC12V ~ 24V
Power Output: 5.0V 1000 mAh
Charger Time: 3.5 ~ 4.0 hours
Active Time: 2.5 hours
Storage Temperature: -4°F to 158°F; -20°C to 70°C
Operating Temperature: 23°F to 122°F; -5° to 50°C
PS: LED Sector: 170°
At 50 cm: 350 LUX (750 LM)
Waterproof Grade IP65



**5551
Spectrum Trio9W LED
Work Light with 3W
LED Top Light**

5551 Specifications

9W LED Work light with 3W LED Top Light
LI-ION Rechargeable Battery – 3.6V 2250 mAh, AC/DC
Charger Input AC 100 ~ 240V; 50/60Hz; DC12V ~ 24V
Power Output: 5.0V 1000 mAh
Charger Time: 3.5 ~ 4.0 hours
Active Time: 3.0 hours
Storage Temperature: -4°F to 158°F; -20°C to 70°C
Operating Temperature: 23°F to 122°F; -5° to 50°C
PS: LED Sector: 25°
At 50 cm: 4000 LUX
Waterproof Grade IP65



**5552
Spectrum 30+430 Pc.
LED Work Light with 4
Pc. LED Top Light**

5552 Specifications

30 Piece LED Work light with 4 Piece LED Top Light
LI-ION Rechargeable Battery – 3.6V 2250 mAh, AC/DC
Charger Input AC 100 ~ 240V; 50/60Hz; DC12V ~ 24V
Power Output: 5.0V 1000 mAh
Charger Time: 3.5 ~ 4.0 hours
Active Time: 4.0 to 5.0 hours
Storage Temperature: -4°F to 158°F; -20°C to 70°C
Operating Temperature: 23°F to 122°F; -5° to 50°C
PS: LED Sector: 15°
At 50 cm: 2250 LUX
Waterproof Grade IP65

- AC/DC Rechargeable
- Li-Ion battery
- Magnetic base
- Bright LEDs - 50,000 hour life
- Adjustable 60° angle
- Slip resistant textured body
- Impact and water resistant
- Limited Lifetime Warranty



HEAVY-DUTY

Diesel Compression Testers	160
Glow Plug Remover / Harness	160
Injector Remover / Installers	161
HD Drain Plug Pro™	162
HD Oil Filter Wrenches	162
HD Snap Ring Pliers	162
Sleeve Puller / Installer / Plates	163-164
Clutch Tools	164-165
Locknut Sockets	166-167
Kingpin & Brake Anchor Pin Push	168-169
Slack Adjuster Pullers	169
Brake Spring Pliers	170
Transmission Puller Sets	170
Fuel Injectors	171
Nozzle Testers	172-173
Oil Filter Crushers / Fluid Receivers	174
Hendrickson Service Sets	175-178
Freightliner Rear Suspension	176
Transmissions Jacks	179
Power Train Lifts	180
Air Lifts / Driveline Lifts	180-181
Clutch Lifts	180
Under Axle Jacks	181
Service Jack	182
Engine Stand	183
Jack Stands	184
Bottle Jacks	185
Wheel Dollies & Track Ramps	186
Tire Bead Seater Tire Spoons	187-188
Hands Free Air Chuck, Tire Bead Breaker, Tire Hammers	189
Tire Spoon Holding Pliers	190
Torque Wrenches	190
Floor Cranes	191-192
Collision Repair Sets	194
DEF Equipment	195
DPF Equipment	196-198





7222 Injector Tube Remover/Installer

- Removes injector tubes for service and re-installs.
- Fits GM 6.6L Duramax Diesel, 2001 to present.
- Similar to J-45910.



7223 Glow Plug Bore Reamer

- Reams glow plug bores for proper replacement of glow plugs.
- Fits GM 6.6L Duramax Diesel, 2001 to present.
- Similar to EN-51249.



6005A Glow Plug Remover

Set includes 10 mm and 12 mm split nuts, three spacers (3/16", 1/4", and 5/16"), plastic storage/organizer case and instructions. The 10 mm split nut will work on Ford 6.9L and 7.3L diesels; GM 6.2L, and 6.5L diesels; and various diesels in import vehicles. The 12 mm split nut works on various diesels in import vehicles, plus many agricultural and construction diesel applications.

Diesel Compression Tester with Adapters

This easy-to-use compression tester is designed for light- and medium-duty diesel engines equipped with glow plugs. A dual-reading gauge, featuring a push-button release valve, measures compression to 1000 PSI and 7000 kPa. The hose end has quick disconnect fittings. The tester comes with glow plug and nozzle adapters in a handy storage case.

Tester services these engines:

- Cummins B and C
- Navistar DT466/DT360
- Ford/Navistar 6.9L & 7.3L
- Detroit 6.2L & 6.5L
- Hino diesel and Mitsubishi Fuso truck engines

5020 Diesel compression tester with adapters
5021 Universal diesel engine compression gauge
Replacement Adapters (available separately)

47484 Hino diesel truck engines with 12 mm x 1.25 thread
217791 Cummins B 3.9L 4 cyl. & 5.9L 6 cyl. '89-'98
308472 Mitsubishi Fuso truck 4D & 6D engines with 10 mm x 1.25 thread

310810 Cummins C 8.3L 6 cyl. '88-'96
310832 Ford/Navistar 6.9L & 7.3L, Detroit 6.2L & 6.5L with 10 mm x 1.0 thread
310840 Navistar DT466/DT360



5020

Similar to Ford 303-D091
(D93T-6000-A)



5021

Similar to Ford 303-D092
(D93T-6000-B)

Similar to Ford 303-D103



6076 Ford Diesel Compression Test Adapter

- Use with OTC No. 5021 diesel engine compression gauge.
- Remove glow plug; this adapter is used to connect the No. 5021 gauge to perform a compression test.
- Application: 1994–2003 Ford vans and pickups with 7.3L direct-injected turbocharged (DIT) diesel engine.

Similar to Ford 303-757



6660 Ford Diesel Compression Test Adapter

- Use with OTC No. 5021 diesel engine compression gauge.
- Works on 2003–2006 Ford vans and trucks—with 6.0L diesel engines.

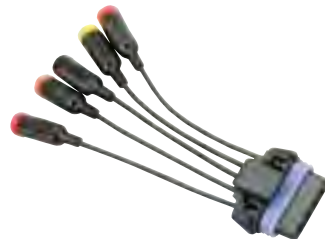

6088 Ford 5-pin Connector Harness for Glow Plug Testing

- Provides an easy way to check glow plug resistance without having to remove the valve cover of 1994–98 Ford trucks and vans with 7.3L DIT (direct-injected turbocharged) diesel engines.
- Used with any standard digital volt ohmmeter to check glow plug resistance.



7835 Ford Rear Main Oil Seal Kit

- Works on 1994–2003 7.3L diesel engine in Ford 3/4- and 1-ton trucks.
- A complete kit with the tools you need to correctly remove and install the rear main oil seal and wear ring on the crankshaft.
- Eliminates makeshift methods of seal removal and installation that could damage the new seal or crankshaft.



GM Duramax Injector Pullers

- Designed to pull injectors on a GM Duramax 6.6L engines.

6778

From 2001 - 2004, Similar to J-44639.

6779

From 2005 - 2011, Similar to J-46594.

Similar to Ford
303-625



6595

Ford High Pressure Oil Line Disconnect Tool

- Use to disconnect the high pressure oil line from the cylinder head.
- Works on 1998–2003 Ford vans and trucks with 7.3L direct-injected, turbo-charged (DIT) diesel engines.



Similar to Miller 8318

6069

Cummins Diesel Fuel Injector Remover Kit

Kit contains a fuel injector connector tube remover and fuel injector puller. The fuel injector connector tube must be removed before removal of the injector, or both will be damaged.

Application: 1998-1/2–2002 Dodge pickups and vans with 5.9L 24-valve Cummins diesel turbo engine.

6754

Diesel Fuel Pressure Gauge

- Designed to test fuel pressure on GM Duramax diesel engines.
- Similar to J-44638.

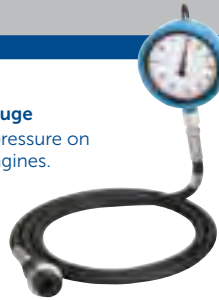

5060

Detroit Diesel Injector Socket

Used on GM 6.2L and 6.5L engines. This 30 mm socket ensures proper fit during nozzle removal and installation. The 3/8" square drive and 7/8" hex permit easy access in tight quarters, and prevent damage to nozzle and related components.



Similar to Ford
No. 303-491
No. 303-492

6067

Ford Injector Remover / Installer Kit

- Removes and installs injectors without damaging the injector or cylinder head.

Application: 1994–2003 Ford 3/4- and 1-ton trucks, Super Duty trucks, and vans with 7.3L direct-injected turbocharged (DIT) diesel engine.

7471A

Cummins Engine Barring Tool

Insert the tool into the flywheel housing until it engages the ring gear, then attach a 1/2" square drive ratchet or breaker bar and turn. The tool's load-bearing collar provides friction-free operation while rotating the tool in the housing.

- Works on Cummins B and C series diesel engines and 5.9L liter diesels used in Dodge pickups.



6749

Diesel Engine Barring Socket

- Designed to rotate engine on a Mack E7 and Cat 3208.
- Similar to J-38587-A.

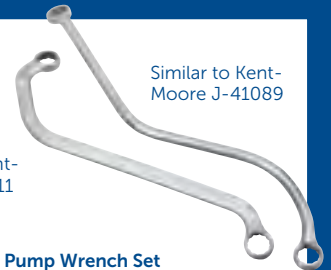

Similar to Kent-Moore J-41089

Similar to Kent-Moore J-41711

6087

GM Injection Pump Wrench Set

- Use to loosen or tighten injection pump retaining bolts whenever pump timing adjustment or pump service is required. Services 1996–1999 GM full-size 2- and 4-wheel drive trucks, vans, and Suburbans with 6.5L diesel engine.
- Two specially bent wrenches are needed, due to the location of the throttle, cruise control, T.V. cable bracket, cooling system crossover pipe and bracket, and the thermostat housing on vans and pickups.
- Wrenches are 15 mm, 12-point, double box-end type.



6752



6753

Designed for the diesel truck market, this tool will work for just about any injector you need to remove for service or replacement.

6752

Fuel Injector Storage Rack with Protective Cups

Compartment are marked to help keep the injectors organized by the cylinder they came from in order to keep the injector calibration in sync with the vehicles ECM. Similar to Ford No. 303-D113.

6753

Protector Cups

A set of eight replacement cups for 6752 Fuel injector storage rack. Similar to Ford No. 303-D115.

OIL FILTER WRENCHES

HEAVY DUTY TOOLS & EQUIPMENT



7248 C-Frame Press

The C-Frame used in conjunction with OTC Ball Joint Adapters. Can also be used for removing/installing universal joints with needle bearings, pressed in wheel studs, and brake anchor pins on heavy-duty vehicles. Suitable for general pressing operations.

6935 U-Joint Service Adapter

For use with the 7248 C-Frame to service the u-joints found on Dana 60 4WD front drive axles.

Application:

- 1977-1991 Chevrolet and GMC 1 Ton
- 1975-2010 Dodge ¾ & 1 Ton
- 2000-2002 Ford Excursion
- 1999-2010 F250 • 1985-2010 F350
- 1999-2008 F450 • 1999-2004 F550



Heavy-Duty Oil Filter Wrenches

- Features a 1/2" wide steel band that can stand up to the high torque needed to remove filters from trucks, tractors, and other heavy equipment.
- Use with a 1/2" drive ratchet or breaker bar.



4555 Heavy-Duty Oil Filter Wrench

Fits filters ranging from 4-1/8" to 4-3/4" (104 mm to 120 mm) in diameter.

4556 Heavy-Duty Oil Filter Wrench

Fits filters ranging from 4-1/2" to 5-1/4" (115 mm to 135 mm) in diameter.

4557 Heavy-Duty Oil Filter Wrench

Fits filters ranging from 5" to 5-3/4" (125 mm to 145 mm) in diameter.



Adjustable Oil Filter Pliers

- Forged jaws with sure-grip teeth grab the filter for easy removal.
- Slip-joint ratchet and lock mechanism allows a secure grip on filters.

4560

Small Adjustable Oil Filter Pliers. Pliers is 13-1/2" long and fits filters ranging from 2-1/4" to 5" (57 mm to 127 mm) in diameter.

4561

Large Adjustable Oil Filter Pliers. Pliers is 18" long and fits filters ranging from 3-3/4" to 7" (95 mm to 178 mm) in diameter.

4562

Adjustable Oil Filter Pliers Set. Includes both the No. 4560 and No. 4561 listed above.

4513

Heavy-Duty Snap Ring Pliers Set (2 piece)

- Heat treated steel "circlip" pliers for large equipment repair.
- Replaceable tips and spring ratchet locking mechanism to securely hold against snap ring tension.
- Internal pliers' capacity 3-1/16" to 6-1/4" (78 mm to 159 mm) snap rings.
- External pliers' capacity 3-1/2" to 6-1/2" (89 mm to 165 mm) snap rings.
- Blow-molded storage case includes extra sets of replaceable tips.
- Overall length 16"; handle length 12-1/2".

4513 includes:

Tool No.	Description	Tool No.	Description
4513-1	Internal snap ring pliers	4513-4	(2) .12" (3 mm) 45° tips
4513-2	External snap ring pliers	4513-5	(2) .12" (3 mm) 90° tips
4513-3	(2) .12" (3 mm) straight tip	4513-6	4 tip retaining screws

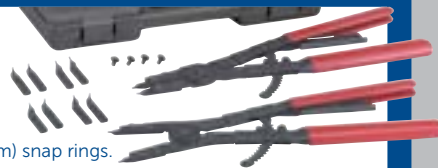

Retaining Ring Pliers

7300 Internal, straight tip retaining ring pliers. 16" long.

7301 External, straight tip retaining ring pliers. 16" long.

See page 110 for replacement tips.



7300 Internal tip



7301 External tip

Giant Adjustable Wrenches

The really big jobs call for really big tools. These wrenches will handle 42 bolt sizes from 1-3/8" to 4-3/4". Together, both wrenches weigh just 41 lbs., but can replace over 1,000 lbs. of fixed-size wrenches.

7640 Giant adjustable wrench. Rated to withstand 2,000 ft. lbs. of torque. Nut/bolt size 1-3/8" to 2-7/8". Increments of Jaw adjustment 1/8", length 24". Head thickness 7/8".

7641 Giant adjustable wrench. Rated to withstand 5,000 ft. lbs. of torque. Nut/bolt size 2-3/4" to 4-3/4". Increments of Jaw adjustment 1/8", length 36". Head thickness 1-1/8".



7640



7641

7463

Gland Nut Wrench

This wrench is fully adjustable to fit hydraulic cylinders on vehicles having gland nuts from 1" to 3-3/4" in diameter. It also reverses to work on either 1/4" or 7/32" pinholes.

- Accommodates a 1/2" drive ratchet.

215128 Replacement pin.



1266

Adjustable Gland Nut Wrench

Here's a wrench designed to fit hydraulic cylinders on most farm and construction equipment. It fits gland nuts from 2" to 6" diameter pin to pin. Includes reversible pins, sizes 1/4" and 5/16" diameter.

- Accommodates a 3/4" drive ratchet or breaker bar.

204928 Replacement pin.



5961HD

Heavy-Duty Drain Plug Pro™

- For Agricultural, Commercial, and Heavy-Duty Vehicle Applications
- Remove fluid drain plugs without touching the plug or hot fluids!
- NO touching HOT plugs.
- NO HOT fluids on hands.
- Removable attachment permits use with common 3/8" square drive sockets. Great for starting bolts in hard-to-reach places.
- Just magnetically attach heavy-duty drain plug pro™ to pre-loosened drain plugs and rotate to remove.
- Magnetic attachment for internal 1/2" square drive drain plugs.
- Magnetic attachment for large drain plugs.



Similar to Ford D79L-6731-A

7062A

Universal Filter Wrench

This filter wrench will stand up to the job of removing nearly any spin-on filter (up to 6"). Universal design permits use on most vehicles. The tough 2" wide nylon strap holds firmly. The more leverage applied, the tighter it grips.

- Accommodates a 3/8" drive ratchet.



5028

Slide Hammer Puller

Just 8-1/2" long to fit into tight spots, but its 1-1/2 pound hammer gives you a little extra muscle for stubborn jobs. It's perfect for pulling injector nozzles. The shank is threaded 1/2" -20 and has a 5/8" -18 threaded adapter included. Works with many OTC pulling attachments.



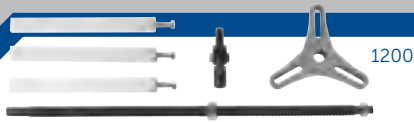

Sleeve Puller / Installer Sets

These sets work on a wide array of truck, bus, and tractor engines, as well as those in other vehicles. They'll handle wet and dry sleeves – and you won't need to remove head studs. Save time, effort, and money.

- Choice of two sets: manual or 17-1/2 ton hydraulic powered.
- Wide range of adapter plates available to fit most engines.

1200 Manual Sleeve Puller Set

This manually operated, screw-powered device removes cylinder sleeves from most truck, bus, and tractor engines. Adapter plates (not included in the set) accommodate a wide range of bore sizes. See application chart below. The puller enables one technician to handle sleeve-pulling tasks. Not recommended for Mack engines (use No. 1202 set).

1201 Installing Conversion Kit for 1200 Set

Permits the No. 1200 sleeve puller to handle both removing and installing operations. Use plate Nos. 1253–1256 for installing, and plate Nos. 1219–1250 for removing. Plates are not included with kit.

1201

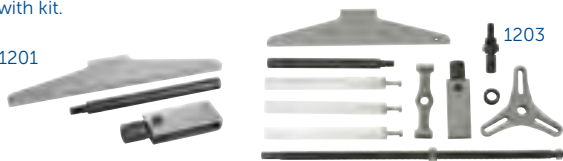

Sleeve puller plate application chart

The puller plates listed here work with manual and 17-1/2 ton hydraulic sleeve pullers	Bore Dia.	Plate No.
J.I. CASE – 207 Diesel	4"	1227
CATERPILLAR – 1673C; 1674; 3304; 3306; D330C; D333C; D334, D326, D337	4-3/4" 5-1/8"	1240 1246
CUMMINS – V Series 903 NT855	5-1/2"	1250
H & NH	4-7/8"	1242
GENERAL MOTORS – 53 Series	3-7/8"	1225
71 Series	4-1/4"	1232
INT'L HARVESTER – C-221, C-263	3-9/16"	1221
D-166, D-188, D-236, D-282, C-248, D-248, D-310, D-358, D-155	3-11/16"	1222
D-179, D-206, D-239	3-7/8"	1225
C-281, D-281, D-361	4-1/8"	1230
D-691, D-461	4-3/4"	1240
D-407	4-5/16"	1233
JOHN DEERE – 4-270, 6-404	4-1/4"	1232
6-531	4-3/4"	1240
6-619	5.12"	1246
8-955	5.512"	1250
MACK – END(T) 673, 675, 676	4-7/8"	1243
672	4-7/8"	1242
END (T) 711, 707	5"	1245
PERKINS – AD3.152, AG3.152, AD4.203	3.6"	1219
AG4.212, A4.236, AG4.236, A6.354, A6.3541, ATC6.3541, AT6.354, AT6.3541	3-7/8"	1223

Universal puller for wet-type sleeves, see 1205.



1202 shown



1205

Universal Puller for Wet-Type Sleeves

This tool will remove cylinder sleeves faster than ordinary pullers because it requires very little setup time. Cone adjustment positions the puller jaws quickly, locking bar is tightened. To aid in breaking "frozen" sleeves loose, adjustable bridge is positioned on the cylinder block and the bearing-mounted forcing nut is tightened. Next, bridge is removed and slide hammer assembly is attached. With a few sharp hammer blows, sleeve is pulled. In most cases, job time will average less than two minutes per cylinder. The puller features a 5 lb. slide hammer to help bust loose even the most stubborn sleeves.

- Special adapters are unnecessary.
- Adjustable jaws fit sleeves 3" to 6-1/2" in diameter.

No. 1201	Description
33769	Screw extension
41291	Installing bar
302340	Yoke assembly



4180

17-1/2 Ton Hydraulic Sleeve Puller Set

Removes and installs sleeves of many makes and models of trucks, buses, and tractors.

- 1202** 17-1/2 ton hydraulic sleeve puller set.
- 1203** Sleeve puller without hydraulic assembly.

No. 1202	Description (includes 1203 and 4180)
37592	Three-way head
33769	Screw extension
302482	Speed nut
302340	Yoke assembly
10088	Cap screws, hex hd (3)
32976	Pulling screw
4180	Hyd. ram/pump assy.
27908	13" risers (3 req'd)
41291	Installing bar
10221	Hex safety nut
208675	Swivel assembly
10586	Flat washers (3)
21714	Insert

Sleeve Removal Plates

Designed to work with set Nos. 1200, 1202, and 1203, these removal plates fit the full spectrum of cylinder sleeve sizes. Determine engine bore size ("A" dimension) and O.D. of sleeve to be pulled ("B" dimension). Then consult chart to the right.

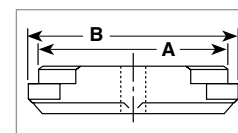

Bore Inches	A I.D. +.010 -.000	B I.D. +.010 -.000	OTC Plate Number
3.600"	3.585	3.657	1219
3-9/16"	3.547	3.663	1221
3-11/16"	3.671	3.792	1222
3-7/8"	3.840	4.047	1223
3-7/8"	3.859	4.093	1225
4"	3.984	4.218	1227
4-1/8"	4.109	4.229	1230
4-1/4"	4.235	4.470	1232
4-5/16"	4.302	4.450	1233
4-3/4"	4.734	5.171	1240
4-7/8"	4.860	4.980	1242
4-7/8"	4.860	5.045	1243
5"	4.977	5.120	1245
5-1/8"	5.093	5.593	1246
5-1/2"	5.484	5.718	1250

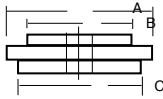

Sleeve Installation Plates

Each of these dry-sleeve installation plates covers a range of bore sizes. Their reversible design makes both sides usable. The plates work with our manual or 17-1/2 ton hydraulic puller/ installers.

(Nos. 1200, 1202, and 1203). Check chart at below to ensure correct sleeve selection.

Fits Sleeves From	A	B	C	No.
3-3/16" to 3-7/16"	3-7/8"	3.171"	3.421"	1252
3-9/16" to 3-7/8"	4-1/4"	3.546"	3.859"	1253
4-1/8" to 4-3/8"	4-3/4"	4.109"	4.359"	1254
4-3/8" to 4-3/4"	5-1/4"	4.390"	4.734"	1255
4-13/16" to 5-3/4"	6-3/8"	4.797"	5.734"	1256



5022 Oil Seal and Wear Ring Installer

This two-piece tool makes the difficult job of correctly installing the rear crankshaft seal and wear ring on most Navistar DT-360 and DT-466 engines thru 1996 an easy task. Bolt the adapter to the crankshaft and wrench the component home.

- Eliminates damage to seals or wear ring that can occur when driving them into place.



7106 Cylinder Liner Height Gauge with Hold-Down Bar

This set lets you meet those exacting specifications necessary for optimum diesel engine performance. It accurately measures cylinder bore flatness and depth. The hold-down bar correctly seats the liner for accurate measurement of liner protrusion. The easy-to-read dial is in .001 inch graduations, 1.000" range.



7161 Cummins Engine Turning Tool

This tool makes easy work of manually rotating a Cummins 855 cubic inch engine. It's essential hardware when you're bringing pistons to top dead center to adjust injector timing.

5039 Charged Air Cooler Tester

This is the easy way to find air leaks in the charged air cooler systems used on class 7 & 8 truck engines. The tester features a large 2-1/2", 0-60 PSI pressure gauge, regulator and relief valve, and two safety cables. It also has quick disconnect air fittings that attach to a 3", 3-1/2", or 4" cooler hose.



5071 Cummins Water Pump Pulley Tool

This heavy-duty tool is designed to remove or install water pump pulleys on Cummins L10 and M11 engines, 1991 and newer. The installer has a rugged thrust bearing that allows for friction-free pulley installation without damaging pump components.



7119 Compressor Drive-Gear Coupling Puller

Here's the solution for removing the coupling from the Cummins Compact and Bendix air compressors found on many Cummins 855 cubic inch engines. The split collet design fits over the coupling, and mechanical force does the work.

- Works on compressors with 1-3/4" O.D. shaft.

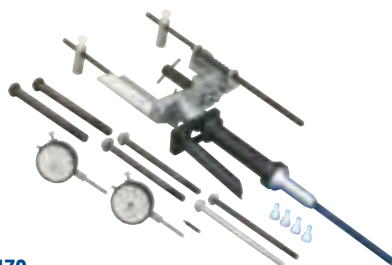

7470 Cummins Diesel Injector Timing Kit

Measures static timing on Cummins J, K, N, NH, V-12, N-14, and L-10 series diesel engines. With this tool you can determine the injector push tube travel in relation to piston travel. Tool is installed with one dial indicator in the injector bore and the other on the injector push tube. Turn the engine over manually to find top dead center. By checking the gauges, you can determine if timing is within factory specifications, then make adjustments to the cam followers.

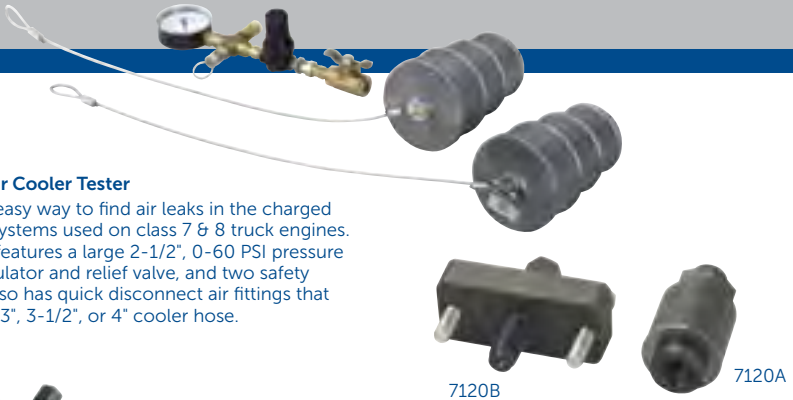

7120 Cummins Drive-Pulley Tool Set

This two-piece set is designed to remove and install the drive pulley on Cummins NH and NTC 855 cubic inch engines. The 7120B remover simply bolts into the tapped holes for pulling. The 7120A installer threads onto the pulley accessory drive shaft for easy installation.

- 7120A** Drive-pulley installer.
- 7120B** Drive-pulley remover.



5044 Self-Adjusting Clutch Rotating Tool

This handy tool replaces the self-adjuster mechanism on Spicer self-adjusting clutches, allowing you to manually adjust them with a wrench or socket.

- 3/4" hex drive.



Pilot Bearing Pullers

These tools make quick work of pulling stubborn, rusted pilot bearings. No. 5048 fits 1-1/4" I.D. bearings, and No. 5049 fits 1" I.D. bearings. The puller's forcing screw expands the jaws inside the bearing and simultaneously pushes against the crankshaft.

- 5048** Pilot bearing puller for 1-1/4" I.D.
- 5049** Pilot bearing puller for 1" I.D.



7028 Clutch-Adjusting Wrench

This clutch-adjusting wrench will solve the difficult, time-consuming job of internally adjusting heavy-duty Spicer clutches. Using this wrench is much quicker and easier than makeshift methods such as pry bars, which often result in component damage, poor job performance, or extra downtime.

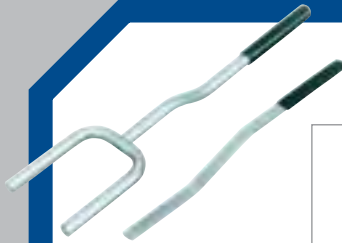

Similar to Ford 308-D008 (D93L-4201-A)

5035 Truck Clutch Adjustment Set

The gauges in this set enable you to check the adjustment of pull-type, heavy-duty clutches, ensuring their correct operation. One gauge checks the amount of free play between the yoke and the bearing's wear pad. The other gauge lets you determine the amount of travel between the release bearing and transmission bearing cap.

- Release bearing travel gauge.
- Clutch pedal free play gauge.

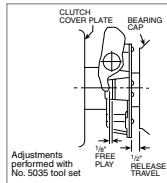

5190A Heavy-Duty U-Joint Puller

The ideal tool for disassembling drivelines.

- May be used with up to a one-inch impact wrench.
- Quickly and easily removes sealed U-joint cups without the need for hammering or heat.
- Will not damage the driveshaft, yoke, bearing cups, or joints.
- Fits practically all Class 7 and 8 trucks, including: Spicer driveline 1610, 1710, 1760, 1810, 1880 Spicer SPL 140, 170, 250 and 350 "Life Series" Meritor (Rockwell) 16N, 17N, 18N, 1710 Meritor RPL 20 and 25 "Permalube" Series.



5192 Heavy-Duty Bearing Cup Installer

Quickly and easily installs bearing cups on bolt-retained universal joints. Fits series 1610 to 1880 and nearly all other heavy-duty truck and machine type u-joints with bolt-retained bearing cups.

- Automatically aligns bearing cups during installation.
- Eliminates the possibility of damage to the needle bearing.

Similar to Ford 308-D009 (D93L7025-A)

Truck Clutch Alignment Shafts

These 10-spline clutch alignment shafts are available in the three most popular sizes: 1-1/2", 1-3/4", 2" O.D., and are designed for use on heavy-duty single, two-plate, push/pull, manual, and self-adjust clutches. The shafts are constructed of lightweight fiberglass-reinforced nylon that won't hang up in clutch disc splines. Yet, they're rugged and will easily support the weight of heavy pressure plates.



- 5070** Truck clutch alignment shaft. 1-1/2" O.D., 30 mm pilot.
- 7072A** Truck clutch alignment shaft. 1-1/2" O.D., 1" pilot, 10 splines, 3.25" long. Similar to Ford 308-D001 (D79T-7550-A).
- 7073A** Truck clutch alignment shaft. 1-3/4" O.D., 1-1/4" pilot, spline 3.75" long. Similar to Ford 308-D002 (D79T-7550-B).
- 7074A** Truck clutch alignment shaft. 2" O.D., 1-1/4" pilot, 10 splines, 3.6" long. Similar to Ford 308-D003 (D79T-7550-C).
- 7480** Truck clutch alignment shaft. 1-3/4" O.D., 1" pilot. Similar to Ford 308-D010 (D93T-7550-A).
- 5029** Clutch alignment shaft. 2" O.D., 1-1/4" pilot, 10 splines, 7.3" long. Similar to Ford 308-D011 (D93T-7550-B).
- 5030** Clutch alignment shaft. 1-3/4" O.D., 1-1/4" pilot, spline 7.375" long. Similar to Ford 308-D012 (D93T-7550-C).



5191 Heavy-Duty Bearing Cup Installer

Quickly and easily installs bearing cups on Dana/Spicer SPL "Life Series" quick-disconnect universal joints.

- Three individual adapters press bearings to the manufacturer's recommended depths.
- Adapters fit Spicer SPL 140, 170, and 250 series drivelines.



7490 U-Joint Tool

Designed for a 1/2" impact wrench, this U-joint tool removes even the most stubborn U-joints with ease. It's compact and easily set up, making it ideal for service calls. And it can be used at different angles and in tight places, eliminating those damaging makeshift methods. The puller's legs have holes for bolt storage.

- Bolts included: 5/16"-24 x 1-1/2", 3/8"-24 x 1-1/2", 7/16"-20 x 1-1/2", M8-1.25 mm x 35 mm.
- Works on most Dana Spicer and Meritor U-joints – except Spicer's Life series model SPL250X.



5043 Clutch Service Set

Here's an ideal companion set to the clutch handler. Designed for Spicer heavy-duty clutches, the nine tools in this set help with a variety of jobs, from clutch installation and removal to flywheel drive-pin installation to clutch adjustment.

- Includes handy plastic carrying case.

OTC No.	Description
5044*	Self-adjust clutch rotating tool. Rotates adjusting ring.
5045*	Flywheel drive pin installing tool. Aligns and installs drive pins in 14" heavy-duty truck pot-type flywheels.
5046*	Clutch release tool. Removes shipping blocks from between clutch housing and release bearing.
7028*	Adjusting wrench. For internal adjustment of multiple lever and angle-spring clutches.
7073A*	Clutch alignment tool. 1-3/4" O.D. Provides perfect fit to spline of clutch disc.
7074A*	Clutch alignment tool. 2" O.D. Provides perfect fit to spline of clutch disc.
213013	Pair of 3/8" flywheel to clutch guide pins.
213014	Pair of 7/16" flywheel to clutch guide pins.
213015	Hex key Wrench. Removes/installs flywheel drive pin set screws.

* Tool is available separately.



7057 U-Joint Puller

This service tool easily removes stubborn, corroded bearings without damaging U-joint components, even in limited space. The tool applies up to 7 tons of force to separate yoke assemblies and remove bearings. Far superior to sledgehammer methods.

- Works on Meritor 16N, 17N, 18N, and 1710 series U-joints and Spicer 1600/1610 to 1880 series U-joints.
- Includes plastic storage box, No. 1036 2-jaw puller, and instructions.

HEAVY DUTY LOCKNUT SOCKETS HEAVY DUTY TOOLS & EQUIPMENT

Wheel bearing locknuts are easy to remove or install with these specially designed sockets. They're made of high-strength steel and resist rounding out.

NOTE: Sockets are designed for use with 3/4" square-drive manual tools only. Impact tool use voids sockets' warranty.

1902 – Similar to Ford No. 205-039 (T70T-4252-B)

1904 – Similar to Ford No. 205-040 (T70T-4252-D)

1905 – Similar to Ford No. 205-041 (T70T-4252-E)

1910 – Similar to Ford No. 205-042 (T70T-4252-K)

1928 – Similar to Ford No. 205-043 (T70T-4252-W)

Measure from flat to flat to determine size of locknut, then consult chart to find the correct socket.



Socket No.	Opening Size	Socket No.	Opening Size	Socket No.	Opening Size	Socket No.	Opening Size
1901	2-3/32" (6 pt.)	1923	2-3/4" (6 pt.)	1924	3-3/8" (8 pt.)	1940	4-1/8" (8 pt.)
1920	2-1/4" (6 pt.)	1937	2-3/4" (8 pt.)	1910	3-1/2" (6 pt.)	1916	4-3/8" (6 pt.)
1902	2-3/8" (6 pt.)	1932	2-7/8" (6 pt.)	1911	3-1/2" (8 pt.)	1917	4-3/8" (8 pt.)
1936*	2-3/8" (6 pt.)	1933	2-7/8" (8 pt.)	1925	3-3/4" (8 pt.)	1938	4-1/2" (8 pt.)
1903	2-3/8" (8 pt.)	1906	3" (6 pt.)	1926	3-3/4" (6 pt.)	1941	4-13/16" (8 pt.)
1921	2-1/2" (6 pt.)	1907	3" (8 pt.)	1927	3-13/16" (8 pt.)	1918	4-7/8" (6 pt.)
1904	2-9/16" (6 pt.)	1934	3-1/8" (6 pt.)	1912	3-7/8" (6 pt.)	1919	4-7/8" (8 pt.)
1905	2-9/16" (8 pt.)	1935	3-1/8" (8 pt.)	1913	3-7/8" (8 pt.)	1939	5-1/4" (6 pt.)
1928*	2-9/16" (6 pt.)	1908	3-1/4" (6 pt.)	1914	4" (6 pt.)	7795	2-1/2" (6 pt.)
1922	2-5/8" (6 pt.)	1909	3-1/4" (8 pt.)	1915	4-1/8" (6 pt.)	7796	2-3/4" (6 pt.)

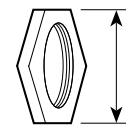

Measure from flat to flat to determine size of locknut, then consult chart to select a socket. Warranty is void if tool is subjected to impact wrench use.



* Fits special "rounded" hex nut found on Dana axles of some Ford trucks.
* Depth of locknut sockets is 5".

Metric Truck Wheel Bearing Locknut Sockets

Socket No.	Opening Size	Socket No.	Opening Size	Socket No.	Opening Size
1950M	54 mm (6 pt.)	1955M	80 mm (6 pt.)	1962M	100 mm (8 pt.)
1951M	55 mm (6 pt.)	1956M	82 mm (8 pt.)	1959M	106 mm (8 pt.)
1952M	60 mm (6 pt.)	1957M	90 mm (8 pt.)	1960M	110 mm (8 pt.)
1953M	70 mm (6 pt.)	1958M	94 mm (8 pt.)	1961M	120 mm (6 pt.)
1954M	71 mm (6 pt.)				

5059 Hubcap Installer

Truckers like chrome, and many of them accent their truck's drive axle with chrome hubcaps designed to snugly fit around the axle-shaft bolts. Unfortunately for service shops, these hubcaps are often tricky to install without causing damage. That's where our hubcap installer comes in handy. Constructed of high-density polyethylene, this tool guides the cap into place over the axle nuts, protecting it from unwanted and costly dents.



5047 Lug Nut Cap Remover

Chrome-plated lug nut caps found on many heavy-duty trucks and trailers can be tough to remove, and they're easily damaged if you pry them off or use an ordinary cap remover. This tool avoids those problems. It is ruggedly built and features specially coated jaws that won't slip off the caps, no matter how much squeezing force you apply.

- Features cushioned handles.



9850 Truck Wheel Bearing Locknut Sockets (6-pt.)

21 wheel bearing locknut sockets with tool board.

62908 Display board only.

No.	Qty.	Description
1901	1	Locknut socket (2-3/32")
1902	1	Locknut socket (2-3/8")
1904	1	Locknut socket (2-9/16")
1906	1	Locknut socket (3")
1908	1	Locknut socket (3-1/4")
1910	1	Locknut socket (3-1/2")
1912	1	Locknut socket (3-7/8")
1914	1	Locknut socket (4")
1915	1	Locknut socket (4-1/8")
1916	1	Locknut socket (4-3/8")
1918	1	Locknut socket (4-7/8")
1920	1	Locknut socket (2-1/4")
1921	1	Locknut socket (2-1/2")
1922	1	Locknut socket (2-5/8")
1923	1	Locknut socket (2-3/4")
1926	1	Locknut socket (3-3/4")
1928	1	Locknut socket (2-9/16" rounded)
1932	1	Locknut socket (2-7/8")
1934	1	Locknut socket (3-1/8")
1936	1	Locknut socket (2-3/8" rounded)
1939	1	Locknut socket (5-1/4")



5047LP Lug Nut Cap Remover Locking Pliers

- Designed to remove lug nut caps found on heavy duty truck and trailers quickly and easily without damage. Caps can be easily damaged by prying or using standard cap removers.
- Locking pliers design with specially coated jaws apply maximum grip on the lug nut caps without damage.



9851

Wheel Bearing Locknut Sockets (8 pt.)

18 wheel bearing locknut sockets with tool board.

62909 Display board only

No.	Qty.	Description
1903	1	Locknut socket (2-3/8")
1905	1	Locknut socket (2-9/16")
1907	1	Locknut socket (3")
1909	1	Locknut socket (3-1/4")
1911	1	Locknut socket (3-1/2")
1913	1	Locknut socket (3-7/8")
1917	1	Locknut socket (4-3/8")
1919	1	Locknut socket (4-7/8")
1924	1	Locknut socket (3-3/8")
1925	1	Locknut socket (3-3/4")
1927	1	Locknut socket (3-13/16")
1929	1	Locknut socket (2-5/8")



No.	Qty.	Description
1930	1	Locknut socket (2-7/8")
1931	1	Locknut socket (3-5/8")
1933	1	Locknut socket (2-7/8")
1935	1	Locknut socket (3-1/8")
1937	1	Locknut socket (2-3/4")
1938	1	Locknut socket (4-1/2")

9852

Wheel Bearing Locknut Sockets

A selection of popular sizes in 6- or 8-point.

62910 Display board only.

No.	Qty.	Description
1904	1	Locknut socket (2-9/16" hex)
1908	1	Locknut socket (3-1/4" hex)
1909	1	Locknut socket (3-1/4" 8 pt.)
1910	1	Locknut socket (3-1/2" hex)
1913	1	Locknut socket (3-7/8" 8 pt.)
1914	1	Locknut socket (4" hex)
1915	1	Locknut socket (4-1/8" hex)
1921	1	Locknut socket (2-1/2" hex)
1922	1	Locknut socket (2-5/8" hex)



No.	Qty.	Description
1923	1	Locknut socket (2-3/4" hex)
1928	1	Locknut socket (2-9/16" hex rounded)
1932	1	Locknut socket (2-7/8" hex)

9814

Truck Pinion Sockets

We've designed and built these sockets to have the correct clearance for yoke and locknut assemblies on a variety of truck transmissions and differentials. The sockets have 3" of usable depth and are 4" long. Using the right tools saves time and effort, eliminating the need to destroy standard sockets by grinding them down to fit tight pinion clearances.

No. 1981* - Socket only, not included in set.

62911 - Tool Board only

Socket No.	Opening Size	Socket No.	Opening Size
1975	2" (6 pt.)	1980	2-3/4" (6 pt.)
1976	2-1/8" (6 pt.)	1981*	2-1/2" (6 pt.)
1977	2-1/4" (6 pt.)	NOTE: Use sockets with 3/4" square-drive, manually powered handles only. Warranty void if tool is subjected to impact wrench use.	
1978	2-3/8" (6 pt.)		
1979	2-5/8" (6 pt.)		



1944 Budd Wheel Sockets

- Metric sizes for Isuzu, Hino, Mitsubishi Fuso, and import trucks; fit front and rear axle wheels.

- 1-1/2" hex Budd wheel socket for American-made trucks with dual rear wheels.

These sockets work on the import truck Budd wheels. Their extra deep design lets you remove both nut and stud with just the one socket. Usable with a 1" square drive impact wrench.

1944 - Consists of 1945A, 1946A, 1947A, 1948A, and 1949A, in a blow molded organizer case.

1945A 35 mm hex socket with 17 mm sq.

1946A 38 mm hex socket with 20 mm sq.

1947A 41 mm hex socket with 21 mm sq.

1948A 33 mm hex Budd wheel socket. For Mack Midliners, White Volvo, and other import trucks with dual rear wheels.

1949A 1-1/2" hex Budd with 13/16" square wheel socket. For American-made trucks with dual rear wheels.

Tubular Spanner Wrenches

- Six-lug, spanner-type wrenches remove and install rear wheel bearing locknuts. They're built for use with a 3/4" square-drive ratchet or breaker bar.



1929 Wrench for servicing Chevrolet and GMC 5,200 and 7,200 lb. axles. Socket O.D. is 2-5/8".

1930 Wrench for servicing Chevrolet and GMC 11,000 to 13,500 lb. axles. Socket O.D. is 2-7/8".

1931 Wrench for servicing Chevrolet and GMC 15,000 lb. axles; 17,000 lb. 2-spd. axles; 15,000 lb. trailing axles. Socket O.D. is 3-5/8".

7217 Locknut Socket

- Designed to fit the axle nut on Chevy Topkick/Kodiak, 2003 - Newer.
- Similar to J-44275.



Jimmy Bars

We've forged these bars from chrome alloy steel, then heat-treated them to resist bending and breaking.

7166 5/8" diameter, 18" long

7167 3/4" diameter, 24" long

7168 7/8" diameter, 30" long

7420 7/8" diameter, 46" long



STEERING / SUSPENSION TOOLS HEAVY DUTY TOOLS & EQUIPMENT



4240A



4241



29424

Kingpin & Brake Anchor Pin Pusher

With this pin remover, hydraulic force and precision tooling replace torch-and-hammer methods for getting the job done quickly and easily. Five special collars and two pins allow this unit to work on both straight and tapered kingpins and accommodates sizes from 7/8" to 2" in diameter and up to 11-1/4" long. The tool delivers 30 tons of hydraulic force to push out even the most corroded kingpins. A job that could consume the better part of a day is done in minutes. The anchor pin can be removed quickly by using the special adapter installed in the pusher's base block and the unit positioned over the brake's spider.

- Works on many models of trucks and buses.
- 27-1/2" high x 8-1/2" wide.
- 30-ton capacity.
- Set includes No. 4002 hydraulic hand pump, No. 9767 hose, No. 9798 hose-half coupler, No. 4121 Power Twin 30-ton ram, and No. 29424 anchor pin adapter.

4240A Complete kingpin and anchor pin pusher set with hydraulics

4241 King- and anchor-pin pusher with anchor pin adapter without hydraulics

29424 Anchor pin adapter only

5053 Mack Kingpin Socket

Here is a socket that makes life a little easier for anyone who works on Mack trucks. Designed for 1/2" square drive ratchet or breaker bar, the socket fits the slotted adjusting screw in tapered kingpins used on most Mack front axles (12,000 to 20,000 lbs.).

- Socket O.D. 1.8"



7503HD Heavy Duty Tie Rod and Ball Joint Remover

A universal heavy-duty puller that removes a wide range of tie rods and ball joints from a variety of cars, trucks, SUVs and heavy-duty vehicles. The 7503HD has a 10-ton pulling capacity, twice the force applied by the original 7503. Jaw spread and reach are increased to 3 and 4 inches for a wider variety of applications and larger vehicles. A heavier duty forcing screw is used, measuring 3/4" - 10, 6 1/2" long with interchangeable tips including cone, flat and cup for multiple applications. The tool will also remove pitman arms and can be used in many pulling situations that require a 2 jaw puller on other vehicles types and machinery.

6065 Tie Rod Socket for Medium-Duty Trucks

- Services GM-, Ford-, and Chrysler-built 1-ton 2WD and 4WD trucks.
- Also works on medium-duty Class 2 through Class 6 trucks.
- Use with a 1/2" drive impact wrench to easily remove the tie rod ends from the tie rod.
- Socket I.D. 2-1/8"



5068 Truck Tie Rod Socket

Designed to withstand the force of a 3/4" drive impact wrench, this rugged socket makes truck tie-rod end removal quick and simple.

- Works on inner and outer tie rod ends on 12,000 to 16,000 lb. truck axles.
- Socket I.D. 2-3/4"

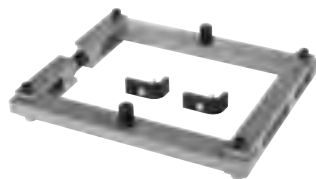
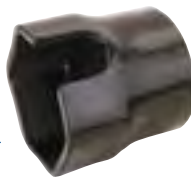

7071 Differential Housing Spreader

Removing and installing differential ring gear assemblies is typically a difficult, time-consuming chore – that is, unless you're using this differential housing spreader. This device uses mechanical screw power to spread the housing. Allowing easy removal of the differential assembly while eliminating damage often caused by makeshift methods.

- Works on Dana axle models 30 through 70.



5079 Heavy-Duty Power Steering Pump Analyzer

- There is only one way to troubleshoot problem components in a heavy-duty power steering system: a flow and pressure reading meter. OTC's new No. 5079 measures both: 1 to 10 gallons oil flow and up to 3,000 psi of pressure.
- When connected in line, this universal analyzer will isolate the failed components in just minutes. There is no wasted time as in trial and error methods.
- The set is complete with high pressure hoses, 9/16"-18 standard fittings, and quick disconnect couplers to handle Eaton/Vickers, TRW, Ross, and Shepard power steering systems.

223018 Accessory fitting kit.



4295 Wheel Stud Service Kit

- Works on most hubs for installation and removal.
 - All sizes of studs.
- Installation done by pushing on the head, eliminating the need for threaded adapters.
 - Reduces number of adapters required
 - Reduces damage to studs
 - Increases ease of use
- Remove and install 10 studs in only 10-15 minutes (compare to 20-30 minutes for more expensive competitive products).
- Can be powered with an impact wrench, no hydraulic power source required.
- No need to remove hub from vehicle.
- Reduces risk of damage to hubs, studs, and bearings when using tool.
- Weighs only 12 lbs., assembled to remove studs and 14 lbs., assembled to install studs.



**SEE PAGE 43
FOR GREASE GUNS**



7180 Universal Bearing Cup Installer

This handy, adjustable tool is designed to install wheel-bearing cups in a wide range of heavy-duty axles. Simply adjust and lock the jaws to the cup I.D., slip on the new cup, set it in the bore, and drive it in with a hammer. The tool helps eliminate the damage caused by makeshift methods.

- Works on axles from 11,000 to 50,000 lb. capacity.
- Adjusts to fit 3-5/8" to 6-1/2" O.D. bearing cups, which adds up to as many as 30 individual drivers.

52038 Replacement jaw.

207561 Replacement retaining spring.



5038 Brake Anchor Pin and Bushing Service Set

With the No. 5038, there's no need to remove the bearing hub assembly just to replace the pins and bushings on 16-1/2" S-cam trailer and tractor "Q" brake systems. Much less complicated and time consuming!

- Special tooling and our C-frame press get you past the hub assembly, so you can do the job quickly and professionally without damaging other parts.
- Includes everything needed for removal and replacement.



5081 S-Cam Air Brake Spring Tool

- Eliminate makeshift, unsafe methods of unhooking and reconnecting retaining springs when replacing brake shoes on heavy-duty tractors and trailers.
- Simply hook the retaining spring loop and press down. Lever action against the axle makes the job a snap!

314548 Replacement hook kit.



5080A Truck Front Leaf Spring, Pin, and Bushing Service Set

- Delivers 10 tons of hydraulic force to remove and install truck front spring eye bushing assemblies quickly and easily.
- Services bushings with diameters from 1-1/4" through 1-7/8", and pin diameters from 7/8" through 1-1/8". Handles all popular OE and aftermarket components, including Horton pin and bushing assemblies.
- Service bushing assemblies, in many cases, without removing leaf spring hangers and spring assemblies from the vehicle.
- All accessories are included except the hydraulic hand pump and hydraulic hose which must be purchased separately.



5085 Hub Oil Seal Puller

- Eliminates bearing and hub damage that can occur when a punch and hammer is used to remove the seal.
- Extra long 28" handle provides leverage, unique pulling head design quickly and easily removes the seal in one piece.
- Built from the highest quality heat-treated steel.
- Removes hub seals on trailer and truck axles, including truck steering axles.



7077 Axle-Stud Cone Pliers

Now you can easily remove the tapered cone from studs used on the rear axles of medium and heavy-duty trucks. This specially designed tool gives you the leverage needed to expand the cone and remove it from the stud for axle removal.

5052 Slack Check

This tool enables you to quickly check the brake adjustment on class 7 and 8 trucks and trailers having S-cam brakes. It features a sturdy, four-position handle to provide the leverage you need at the proper angle.

- Works on manual or automatic slack adjusters.



Slack Adjuster Pullers

These pullers will yank even the most corroded slack adjuster off the S-cam— and do so in just a fraction of the time needed with "heat and beat" methods. Plus, they won't damage components. Both pullers have a rugged forcing screw and cast steel body. Puller No. 5055 fits many manual types, and the No. 5056 works on Rockwell, Haldex, Gunite, and Bendix automatic adjusters.

5055 Manual slack adjuster puller.

5056 Automatic slack adjuster puller.



5054 Air Brake Service Kit

This kit has the tools needed to remove slack adjusters and push-rod clevis pins used in the S-cam brake systems of class 7 and 8 vehicles.

- Works on manual or automatic slack adjusters.
- Includes Nos. 5055 and 5056 slack adjuster pullers, 5057 brake clevis pin press, and a plastic storage case.



5057 Clevis Pin Press

Removing corroded clevis pins from a brake air-chamber push rod can be a maddening and time-consuming task— unless you're using our clevis pin press. This handy screw-operated tool applies the force just where it's needed. The pin is easily removed from its hole without damaging nearby components.



5089 Air Brake Line Release Tools

Tools used to separate connectors on the P/S system and EGR coolers without damage. Also works on connectors on other liquid and air lines. Each tool has two sizes. 3/8" and 5/8"; 1/2" and 3/4". Similar to J-45666 & J-42971. Applications: 2003-later Medium Duty trucks.

BRAKE / TRANSMISSION TOOLS HEAVY DUTY TOOLS & EQUIPMENT

4592 Truck Brake Spring Pliers

• Designed to remove and install the brake shoe return springs on medium-duty and heavy-duty drum brakes.

4592-1 Replacement tip.

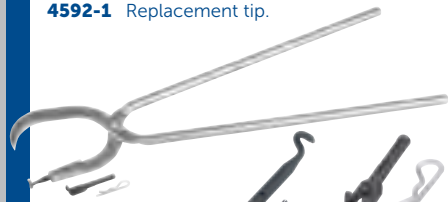

7069A Heavy-Duty Brake Spring Pliers

Save time and effort when removing and installing return springs on the brake shoes of heavy-duty vehicles. This specially designed pliers works for hydraulic wedge-type and "S" cam air brakes. Its 26-1/4" length gives you the leverage to do the job more easily, and the huge jaw opening accommodates even the widest brake shoes.

202621 Wedge-type replacement tip

204141 "S" cam replacement tip

202621 204141

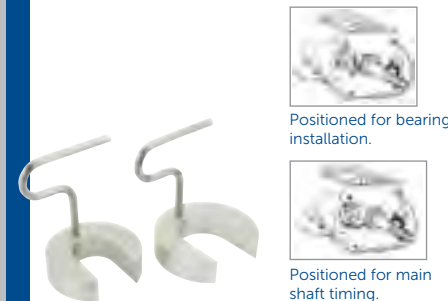

Positioned for bearing installation.



Positioned for main shaft timing.

Transmission Timing Block Sets

These sets enable one-man installation of front and rear countershaft bearings on Fuller twin-countershaft transmissions. The set positions the upper countershaft, yet lets you slide it aside to insert the main shaft. When the main shaft is in place and timing marks line up, turn the tool vertically to engage and position the countershaft to main shaft.

7108 Timing block set for Fuller RTO 610/613 transmissions.

7109 Timing block set for Fuller RT and RTO 910, 915, 9513, 12509, 12510, 12513, and 12515 transmissions.



5063 Timing Tool

• Designed to support the main-case upper countershaft during transmission assembly and timing.
• Works on Eaton® Fuller® 2 Series Roadranger® transmissions.

Truck Transmission Bearing Service Set

The set is designed to help you remove input shaft bearings and countershaft bearings, in both the main and auxiliary boxes of heavy-duty Fuller transmissions. It will also remove end yokes from 1600/1610-1810 series transmissions. The puller delivers 10 tons of mechanical power—essential force for working on big gearboxes.

• Works on Fuller twin-countershaft transmissions: 125, 600, 660, 900, 9500, 1100, 12500, 12600, 13000, 14600, 15600, and 8600 series, 910-913, 915, and 9513.

7070A Truck transmission bearing service set

7075 Transmission output shaft end yoke remover only



7462 Hydraulic Brake Spring Tool

Here's a tool to remove and install the return springs in Lucas Girling hydraulic brake systems. The tool's machined tip cradles the return spring securely, and its sliding fulcrum gives you all the leverage needed to do the job. A knurled handle helps prevent slipping.

• Works on 1984 to current Ford F600, F700, and F800 series having Lucas Girling hydraulic brakes.



Similar to Ford 206-D005 (D90T-2588-A)

5072 Lucas Rear Brake Adjusting Tool

If you're working on a lot of medium-duty hydraulic brake systems, you need our adjusting tool. It enables you to easily adjust Lucas Girling hydraulic brake systems (popular in Ford F700, F800, and F900 series). The tool's offset design and extra handle length get the job done quickly.



205776 Bearing Puller Set

This puller set, designed for use with our No. 7070A transmission service set (sold separately), is designed to remove front countershaft and input shaft bearings on Fuller RT, RTO 610/613 twin countershaft transmissions.



5051 Bearing Puller Set

When teamed with our No. 7070A puller, this puller set will remove front and rear countershaft bearings from the main case of Eaton® Fuller® 2 Series Roadranger® transmissions.

• Includes pulling collet, sleeve, and a pair of puller legs.

5064 Countershaft Pushing Tool

Replacing rear countershaft bearing snap rings in Eaton Fuller transmissions. With this tool, you can easily move the countershaft rearward to expose the snap ring.

• Works on Eaton® Fuller® Roadranger® transmissions (series 2, 5, 6, and 7).

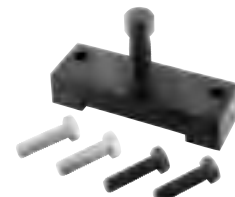

5065 Countershaft Bearing Driver

• Eases the task of installing a main-case countershaft bearing.
• Works on Eaton® Fuller® 2 Series Roadranger® transmissions.



5066 Bearing Driver

This tool is designed to install the bearing on 2" diameter input shafts used in Eaton® Fuller® Roadranger® transmissions.



Made of aircraft quality steel.

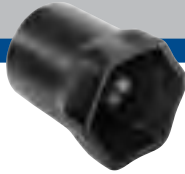

1982M 70 mm Hex Socket

Attach this heavy-duty socket to your 3/4" drive ratchet or breaker bar, and you'll be able to easily remove the end-yoke locknut on Eaton® Fuller® 2 Series Roadranger® transmissions.



5040 Cummins® Injector Remover/ Installer

This is our best tool for removing or installing fuel injectors on Cummins L10 and N14 Select electronically controlled engines. The large slide hammer and pin-type pulling adapter easily—and safely—handle injector jobs.

- Includes storage case.
- Two installing adapters help prevent damage to an injector's electronic solenoid.



5042 Cummins® Injector Puller

This helpful puller will handle a variety of injectors found in Cummins engines: mechanical L-10, PDT, and PTD top-stop 855NH. Its two-jaw design firmly grips the injector while it is being removed by the slide hammer.

- Includes storage case and special adapter for pulling STC injectors.



5062 Auxiliary Countershaft Shim Tool

When you're working on Eaton® Fuller® 2 Series Roadranger® transmissions, this tool holds the auxiliary countershaft in place while you set the bearing end play.

- Includes a support strap for .100 and .125 shim settings, and metric and standard mounting bolts.



7455 Mack Fuel Injector Nozzle Tool

Here's a handy tool for removing or installing injector nozzles on Mack E-6 4 VH and E-9 4 VH four-valve engines. The puller threads directly into the nozzle holder, and mechanical screw power does the pulling while a cylindrical guide holds the injector steady.

- Includes gauge to ensure correct injector depth during installation.



Cummins® Fuel Injector Puller Adapter

When combined with our No. 5028 injector puller or a slide hammer with a 1/2"-20 threaded shaft, this adapter gives you an easy, damage-free way to remove fuel injectors from Cummins B and C series engines.

215844 Cummins fuel injector puller adapter for B and C series engines with 14 mm x 1.5 injector threads.



7117 Caterpillar Fuel Injector Nozzle Puller

We've designed this nozzle puller to remove pencil nozzles on Cat engines. The tool applies straight, even pulling power through a bridge assembly and mechanical forcing screw. The job is done quickly—and without damage.

- Works on Caterpillar 1100/3208 diesel engines.



7121 Fuel Injector Nozzle Puller

We've designed this puller to remove the pencil-type fuel injector nozzles used in many agricultural and construction engines. The slide hammer action gives a straight, even pull without damaging components.

- Works on Case, Caterpillar, GM, John Deere, Waukesha, and White diesel engines.



7458 Bosch Nozzle Socket

Removes or installs injector nozzles. You use the inner socket to hold the nozzle stationary, and the outer socket to loosen or tighten the nozzle's gland nut.

- Works on Bosch KDEL 21 mm injector nozzles used in John Deere engines.

218163 Ford Fuel Injector Puller Adapter

Designed to work with the No. 5028 slide-hammer puller, this adapter removes injectors from Ford 6.6L and 7.8L diesel engines without damage.

- Slide-hammer threads are 1/2" x 20. Threaded end for injector is 14 mm x 1.5.

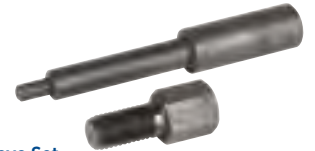

5024 Injector Sleeve Set

Here are the ideal tools for removing and installing the injector sleeves of International 1995 - 2003 DT466 engines. The removing tool threads onto a slide hammer with 5/8" - 18 threads to remove sleeves quickly. The installer seats new sleeves equally fast, without damage.

Similar to Ford 303-230(T83T-9396-A)

Diesel Fuel Line Wrenches

Fuel line nuts are often hard to reach, but these unique 3/8" square-drive tools solve that problem. With them, you can loosen or tighten fuel lines at the fuel injector nozzle or fuel injection pump without damaging the nut.

7453A Fuel line wrench, 2.6" long. For International DT466 and 9L diesel engines. Fits 19 mm fuel line nuts.

7460 Fuel line wrench, 2.6" long. For International 6.9L and 7.3L diesel engines. Fits 5/8" hex nut.



6080 Cummins Diesel Fuel Injector Kit

For 1988-98 Dodge pickups and vans with 5.9L 12-valve, and 1998-1/2-newer 5.9L 24-valve Cummins diesel engines

NOZZLE TESTERS HEAVY DUTY TOOLS & EQUIPMENT

4201

Nozzle-Tester Adapter Set

This is our universal adapter set for testing injection nozzles on the most popular automotive, agricultural, and construction diesel engines. The set has 17 adapters that connect to our No. 4200 Nozlrater testing unit.

- Includes handy metal storage box.
- 23622— used on 1989–95 Cummins 5.9L, 1983–94 Ford 6.9L and 7.3L.
- 23623— used on 1996–2000 Cummins 5.9L and Navistar 6.6L and 7.8L.



Adapter No.	Description	I.H. Truck	I.H. Farm Construction	John Deere	Oliver & Allis	Waukesha	Case, Ford Tractor, Massey, & Perkins	White	Mack	Caterpillar Pencil Nozzles	Deutz	GM Autos	VW, Audi, & Mercedes Autos	Mercedes & Magaris Truck
36352	Fuel line assembly, 9/16"–18 R.H. thd. with 24° on pipe.	•	•	•	•	•	•	•	•	•	•	•	•	•
23622	Adapter nut, 12 X 1.5 mm internal R.H. thd. to 1/2"–20 internal L.H. thd.	•		•	•	•	•	•			•	•	•	
23623	Adapter nut, 14 X 1.5 mm internal R.H. thd. to 1/2"–20 internal L.H. thd.	•	•	•	•	•	•		•		•			•
23624	Adapter nut, 18 X 1.5 mm internal R.H. thd. to 1/2"–20 internal L.H. thd.		•		•	•	•							
201917	Adapter nut, 9/16"–18 internal R.H. thd. to 1/2"–20 internal L.H. thd.	•	•	•	•	•	•	•				•		
23626	Adapter nut, 5/8"–18 internal R.H. thd. to 1/2"–20 internal L.H. thd.	•	•		•	•	•							
201912	Adapter nut, 3/4"–16 internal R.H. thd. to 1/2"–20 internal					•								
201913	Adapter nut, 9/16"–24 internal R.H. thd. to 1/2"–20 internal L.H. thd.	•	•											
23693	Straight adapter, 1/2"–20 external L.H. thd. (Ermeto 24° & 90° seat) to 9/16"–18 external R.H. thd. (E201917°).	•	•	•	•	•	•	•				•		
23692	Straight adapter, 3/8"–24 external R.H. thd. to 9/16"–18 external R.H. thd. (internal Ermeto 24°).	•	•											
23617	90° adapter, 9/16"–18 external R.H. thd. (Ermeto 24°) to 9/16"–18 internal R.H. thd. (Ermeto 24°).	•	•	•	•		•		•		•	•	•	•
23621	Straight adapter, 9/16"–18 external R.H. thd. (Ermeto 24°) to 1/2"–20 external L.H. thd. (60° seat).	•	•	•			•	•	•		•	•	•	•
208370	Banjo adapter, 9/16"–18 external R.H. thd. (24° seat).		•	•										
201916	Adapter, 9/16"–18 external R.H. thd. to 9/16"–18 internal R.H. thd. ferrule.			•										
208369	90° adapter, 9/16"–18 external R.H. thd. to 9/16"–18 internal R.H. thd.	•												
38279	Straight adapter, 14 X 1.5 mm external R.H. thd. (Ermeto 60°) to 9/16"–18 external R.H. thd. (internal Ermeto 24°).			•										
43468	Straight adapter, 1/2"–20 external R.H. thd. (Ermeto 24°) to 9/16"–18 external R.H. thd. (internal Ermeto 24°).							•						
Additional Accessories Available (not included in 4201 Set)														
44026	Straight adapter, 9/16"–18" R.H. thd. (Ermeto 24°) to Caterpillar 1100 & 3200 series pencil nozzle.									•				
201920	Adapter nut, 14 X 1.5 mm external thd. to o"–18 internal R.H. thread													Connects OTC 4200 Nozlrater to other fittings used in the industry.



Nozzle Tester Manifold/Adapter Sets

These adapter sets expand our No. 4200 Nozlrater to troubleshoot a wide range of diesel engine injector nozzles.

4202 Adapters for servicing Audi, GM, Mercedes-Benz, Nissan/Datsun, Toyota, and VW Rabbit diesel engines.

4203 Manifold/adapter set. Tests Caterpillar high- and low-pressure, capsule-type nozzles, and high-pressure, pencil-type nozzles on 1100 and 3200 series engines. Complete with Nos. 39870 and 206168 adapters, low-pressure gauge (up to 1,000 PSI), cap plug and mounting brackets.

No. 4202 set includes:

Adapter No.	Description	Chevy Chevette & GM 1980 and newer C.A.V. nozzles	GM 1979 & newer pencil nozzles	GM 1978 pencil nozzles	Nissan, Toyota, and VW Rabbit Diesels	Audi & Mercedes-Benz
36352	Fuel line assy., 9/16"-18 R.H. thd. with 24° on pipe.	•	•	•	•	•
23617	90° adapter, 9/16"-18 external R.H. thd. (Ermeto 24°) to 9/16"-18 internal R.H. thd. (Ermeto 24°).	•	•	•	•	•
23621	Straight adapter, 9/16"-18 external R.H. thd. (Ermeto 24°) to 1/2"-20 external L.H. thd. (60° seat).	•	•	•	•	•
23622	Adapter nut, 12 X 1.5 mm internal R.H. thd. to 1/2"-20 internal L.H. thd.	•	•	•	•	•
201917	Adapter nut, 9/16"-18 internal R.H. thd. to 1/2"-20 internal L.H. thd.	•	•	•	•	•
23693	Straight adapter, 1/2"-20 external L.H. thd. (Ermeto 24° & 90° seat) to 9/16"-18 external R.H. thd. (Ermeto 24°).	•	•	•	•	•

4200

Nozlrater Diesel Injector Nozzle Tester

Here is the ultimate tool for diagnosing a number of problems that affect diesel fuel injector nozzles. The Nozlrater tester enables you to check for leakage, pop-off pressure, spray pattern, and chatter. This tool will accommodate a wide range of injectors. We also offer adapters so you can troubleshoot nozzles used in popular automotive, agricultural, and construction engines. Nozlrater features a rugged, lightweight reservoir that holds 7/10 of a gallon of fuel. It is equipped with a replaceable 2-micron filter. The large, dual-scale, high-pressure gauge is protected by a guard and includes an indicator needle to record maximum pressure reached. The tester is light enough to be easily carried for field use. Or you can bench-mount it, using the holes in its base.

• Not designed for Cummins or Detroit injectors.

17169 Replacement filter.

11565 Gauge.



Specifications

Overall width	5-3/4"
Overall length (includes handle)	26"
Overall height	11-1/4"
Weight (empty)	15 lbs., 10 oz.
Max. pressure	5000 PSI (350 bar)
Max. reservoir cap.	.692 gal. of diesel fuel (160 cu. in.)
Usable reservoir cap.	.628 gal. of diesel fuel (145 cu. in.)
Outlet port	For 3/8" tube
Gauge	Calibrated 0-5000 PSI (350 bar) Has 3-1/2" dial face with maximum reading indicator needle.
Gauge connection	1/4" NPT internal
Stroke of 1/2" dia. piston	3/4"
Volume per full stroke	.147 cu. in. (2.4 cc)
Intake filter	2 micron



208629

Calibration Fluid

• For use in diesel injection pump testers and injector nozzle testers.

• 1 gallon



Davco Diesel Filter Wrenches

• Found on Caterpillar, Cummins, Detroit Diesel, International, Mack, Mercedes-Benz, Volvo and other engines.

• Durable, stainless steel construction.

• Precise, laser-cut angles.

• Opens vent cap also.

• Soft, ergonomic handle.

6914 Fits Davco Diesel filter models, 232-233-234.

6915 Fits Davco Fuel filters 382 & 384.



6916

Duramax Water Sensor Wrench

• Used to remove and install the water sensor on the fuel filter.

• Works on 2001 and Newer 6.6L Duramax Diesel found in Chevrolet and GMC Trucks and Vans.

• 3/8" square drive hole.

OIL FILTER CRUSHERS / FLUID RECEIVERS HEAVY DUTY TOOLS & EQUIPMENT



1821 10-Ton Capacity, Air-operated Automotive Oil Filter Crusher

- Crushes up to four automotive filters (3-7/8" dia. x 9" high) at one time, in approximately 20 seconds. Engineered and built for dependable operation. Covered by OTC Lifetime Warranty®.
- 100% air operation eliminates electrical connections. Generous size of crushing chamber easily accommodates the largest automotive spin-on filters.
- Includes mounting stand. No wall mounting or time consuming installation required.



1877 25-Ton Capacity Heavy-Duty Oil Filter Crusher

- Handles the big filters (up to 6" dia. and 12-1/2" long) found in trucks, construction equipment, farm implements, etc. May also be used for automotive and light truck filters. It does it all!
- Crushes filters to 1/4 of original size, removing up to 95% of filter's oil capacity. Automatic cycle feature: load the filter, push a button, and walk away.
- Air/hydraulic pump works on standard shop air (requires 9 CFM at 100 psi). Special valving returns ram automatically at the end of each cycle. No electrical connections needed.
- Built-in floor stand (completely assembled). Whole unit requires just 5 square feet of floor space.
- Covered by OTC Lifetime Warranty®.



Shipped assembled

1896 25-Ton Capacity High-Speed Heavy-Duty/Automotive Oil Filter Crusher

- Automotive and heavy-duty filters up to 15-1/4" long and 6" diameter are crushed in approximately 8 to 16 seconds. Filters are reduced to 20% of original size, with 95% of residual oil removed.
- Automatic cycle feature lets you load the filter, push a button, and walk away.
- Powered by 2 hp electric/hydraulic pump, 230 volt, 20 amp, 60 cycle, single phase, 3,450 rpm. Has a 2-gallon reservoir.
- Built-in, heavy-duty floor stand with leveling pads is designed to accept a 30-gallon drum for oil drainage. Comes assembled. Covered by OTC Lifetime Warranty®.



SEE PAGE 35
FOR OIL FILTER
WRENCHES

Oil Filter Crusher Comparison Chart

No.	Tonnage	Pump	Crushing Time	% Oil Removed	Filter Size	Stand Dimensions
1821	10-ton	Air	20 Seconds	95%	Chamber: 8" x 8" x 9" H.	18-1/2" W x 24" D x 63-1/2" H
1877	25-ton	Air/Hyd.	80 Seconds	95%	6" Dia. - 12-1/2" Long	18-1/2" W x 30" D x 74-1/2" H
1896	25-ton	Elec./Hyd.	16 Seconds	95%	6" Dia. - 15-1/4" Long	27" W x 30" D x 78" H

Note: Crushing times are approximate; crushing times may vary depending on air pressure available, size of filter, type of filter, etc.

Transfer Tankers

- Draining oil from a large displacement engine and getting it to your bulk storage container is a snap with OTC's Transfer Tankers.
- Used oil is collected in a reservoir, and then rolls smoothly on 4" free-wheeling casters to your storage location.
- Pump moves five gallons a minute through the 8-foot transfer hose to the a 15-gallon reservoir.
- Handle is removable for easy storage.
- Screen attached to reservoir allows assembly to be stored on its side.
- Can also be used for transferring antifreeze.

5077A Low profile Transfer Tanker is only 7-1/2" from floor to top of reservoir. Comes equipped with an electric pump (No. 528093).

5097 Low profile Transfer Tanker is only 7-1/2" from floor to top of reservoir. Comes equipped with a pneumatic pump (No. 529966).



5077A



5097



1577 Low Profile Fluid Receiver

- Designed for receiving waste fluid during a wide range of repair jobs.
- Fluid capacity: 7.5 gallons.
- Constructed of polyethylene plastic for heavy-duty use—yet, only weighs 13 pounds.
- Low profile, only 5" high, it easily slides under passenger cars.
- Designed with four casters to provide efficient maneuverability.
- Suitable for cooling system repair jobs—can be used for antifreeze.
- Includes splash screen to prevent spillage and splashing.
- Two-year warranty.

HENDRICKSON SERVICE SETS

Rear Suspension

4246

Hendrickson Rear Suspension Bushing Tool Kit

- Replace rusted and frozen heavy-duty rear suspension bushings faster and easier
- Patent-pending design is suspension-mounted, eliminating the need to hold the tool during operation
- Remove/install Hendrickson PRIMAAX EX, COMFORT AIR, FCCC V Ride™ Pivot and D-Pin Bushings
- Save time and effort during suspension service to get trucks back on the road faster
- Included adapters align tool with the suspension to ensure proper bushing installation and reduce the chance of misalignment and bushing damage
- Includes an OTC 4106A 25-ton high-force cylinder

4247

- Adds an OTC 2510A air/hydraulic pump to make bushing service faster and easier
- Includes everything in the 4246 kit

4250

Hendrickson Adapter Kit for Front Suspensions

- Use with your 4246 or 4247 Rear Tool on select Hendrickson Front Suspensions
- Remove and install Hendrickson PACCAR Monoleaf, Navistar Monoleaf, Volvo Monoleaf suspension Pivot Bushings



4246



4247



4250

Front Suspension

4274

Hendrickson Front Suspension Bushing Tool Kit

Replace rusted and frozen heavy-duty front suspension bushings faster and easier

- Patent-pending design is suspension-mounted, eliminating the need to hold the tool during operation
- Remove and install Hendrickson PACCAR Monoleaf, Navistar Monoleaf, Volvo Monoleaf suspension Pivot Bushings
- Save time and effort during suspension service to get trucks back on the road faster
- Included adapters align tool with the suspension to ensure proper bushing installation and reduce the chance of misalignment and bushing damage
- Includes an OTC 4106A 25-ton high-force cylinder

4275

- Adds an OTC 2510A air/hydraulic pump to make bushing service faster and easier
- Includes everything in the 4274 kit

4254

Hendrickson Adapter Kit for Rear Suspensions

- Use with your 4274 or 4275 Front Tool on select Hendrickson Rear Suspensions
- Remove and install Hendrickson PRIMAAX EX, COMFORT AIR, FCCC V Ride™ Pivot and D-Pin Bushings



4274



4275



4254

BUSHING SERVICE HEAVY DUTY TOOLS & EQUIPMENT

4263 Suspension Bushing Tool

- Suspension bushing tool used to remove and replace suspension bushings. The hydraulic cylinder and press plate assembly mounts to the suspension component or leaf spring for hands free operation and eliminates the need to hold heavy equipment. Used in conjunction with the bushing adapter sets designed to fit specific bushings and suspension components.
- 15 ton capacity



4263

4261 Hendrickson Front Suspension Bushing Tool

- Suspension bushing tool kit used to remove and replace the leaf spring bushings on Hendrickson Airtek NXT front suspensions found on Freightliner Cascadia vehicles. The hydraulic cylinder and press plate assembly mounts to the leaf spring for hands free operation and eliminates the need to hold heavy equipment. Press plates and bushing adapters are specifically designed to fit the front leaf spring and bushing.
- 15 ton capacity.



4261

4255 Hendrickson Airtek NXT Bushing Adapter Kit

- This adapter kit is used in conjunction with the 4263 Suspension Bushing Tool to remove and replace the leaf spring bushings on Hendrickson Airtek NXT front suspensions found on Freightliner Cascadia vehicles. Plate, adapters and cups make bearing removal and installation faster and easier than other methods.
- Plate, cup and adapters specially designed to fit Airtek NXT front suspension
- Included adapters and cups allow bushing to be pressed out and new bushing to be pressed in
- Adapters aid with installation to help ensure a straight, clean installation of vital suspension bushings



4255



1757 Hendrickson Bar Pin Adapter Set

- Adapter set is used with the beam removed from the truck, and in conjunction with OTC No. 51100 press plate and a 100-ton hydraulic shop press.
- To remove bushings, use OTC's previously introduced No. 302030 removing adapter and No. 206457 press adapter, both of which may be ordered separately. Reinstall bushings following procedures recommended by the suspension manufacturer.

1767 Hendrickson Primaax Quick Alignment Socket

- Hendrickson – Approved tool.
- Used to adjust axle alignment on the Primaax air suspension.
- Works on Primaax models 230, 460, and 690 rear suspensions.



1768 Hendrickson PRIMAAX® Quick Wrench

- Used to torque cross tube end cap bolts and longitudinal torque rod top pad bolts.
- Reduces maintenance time by eliminating the need to remove the tires to gain access to the end cap bolt.
- Use with the following Hendrickson PRIMAAX suspensions:
 - Type A - PAX 230/460/690 and FMX 240/480 with 8-1/2" ride height
 - Type B - PAX 230/460/690 with 10" ride height.



Freightliner

Freightliner Rear Suspension Tool

- Removes and installs single-wrapped FAS II Airliner Freightliner Rear Suspension bushings in a fraction of the time of traditional methods.
- Saves an average 45 minutes per bushing (4 per vehicle) on flat rate of 1.5 hours per bushing.
- 15 ton Capacity cylinder

4244 Freightliner Rear Suspension Tool

4245 Freightliner Rear Suspension Tool includes 2510A Air/Hydraulic Pump.



4244

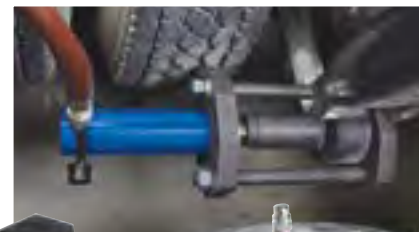

4245

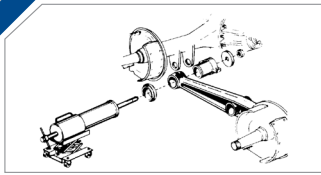

1740 tooling setup for end bushing installation.

**1740
Basic Tooling Set**

This is the basic tooling set for servicing center and end beam bushings. It does not include the hydraulic pump or gauge. If you are already equipped with hydraulics, you can be replacing bushings right away! (Does not include tooling for hanger tube or end plug adapter removal.)

For 340 thru 450 Series Hendrickson Suspensions

Item	No.	Description
A	44119	Receiving tube
B	51678	80-ton cylinder
C	51695	Jack cart
D	206457	Press adapter
E	206459	Clamp plate
F	9780	Hydraulic hose
G	302018	Spacer (2)
H	302019	Receiving adapter
J	302021	Receiving adapter
K	302023	Pulling screw

Item	No.	Description
L	302026	Installing adapter
M	302027	Removing adapter
N	302028	Hex nut
O	302029	Speed nut
P	302030	Removing adapter
Q	302031	Installing adapter
R	302032	Removing adapter
S	302401	Spacer ring (3)
T	42052	Inst. adapter clamp

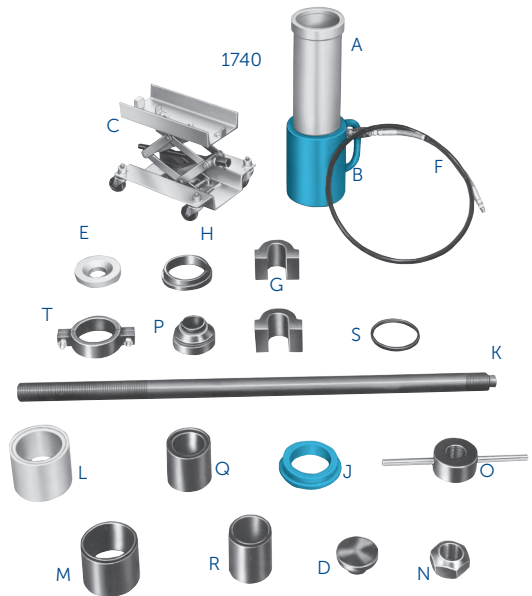

HENDRICKSON SERVICE SETS WITH HYDRAULICS

FOR 340 – 450 SERIES HENDRICKSON SUSPENSIONS

**1742
Basic Tooling Set with hydraulics (Hydraulic pump 4031)**

The preferred method for servicing center and end beam bushings. You get the complete No. 1740 basic set, plus OTC's No. 4031 two-stage electric/hydraulic pump with remote hand switch, a No. 9654 pressure gauge, hose half coupler, and 80-ton single-acting ram. (Tooling for hanger tube or end plug adapter removal not included.)

**1741
Basic Tooling Set with hydraulics (Hydraulic pump 4062)**

The method Hendrickson recommends for suspension service. You get the No. 1740 basic set, plus OTC's No. 4062 two-stage electric/hydraulic pump with remote hand switch, a No. 9653 pressure gauge, hose half coupler, and 80-ton single-acting ram. (Tooling for hanger tube or end plug adapter removal not included.)

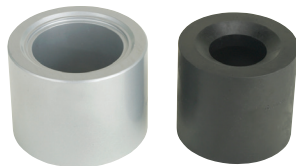

**1746
R400 Center Bushing Adapter Set**

For R400 series Hendrickson suspensions having center bushing No. 49400 or field service center bushing No. 49600.

Used with OTC's No. 1740 suspension tool set, these adapters let you remove and install the new style R400 center bushings on Hendrickson suspensions.

- 310248** Removing adapter
- 310249** Installing adapter

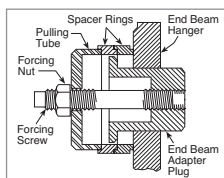

**1745
End Bushing Adapter Puller Set**

Set contains everything needed to remove end bushing adapter plugs in 380 thru 440 series suspensions. The plugs have to be removed prior to end bushing replacement.

The set is complete in a handy plastic case.

For use with 1740 series tooling sets (order separately).



Item	No.	Description
A	207025	Spacers (3)
B	302592	Screw (7/8"–14)
C	302593	Screw (15/16"–12)
D	207027	Screw
E	207026	Plug gauge
F	207030	Hand tap (7/8"–14)
G	207031	Hand tap (15/16"–12)
H	207039	Nut assembly
I	302595	Receiving cup



1749 Hendrickson Suspension Bar Pin End Bushing Adapter Set

Extend your No. 1741 and No. 1742 bushing service equipment sets. You can now remove and install worn end bushings on the Hendrickson new style bar pin end bushings without removing the equalizing beam from the vehicle. The No. 1749 works in conjunction with OTC's No. 1741 and No. 1742 80-ton portable service equipment to do the job quickly, using procedures recommended by the manufacturer.

1744 Bronze Center Bushing Service Set

Designed for replacing bronze center bushings on 340, 380, 440, and 460 Hendrickson suspensions. Also installs bronze center bushing grease seals. For use with 1740 series tooling set (order separately).

For 340, 380, 440, & 460 series suspensions.

Item No.	Description
A 28536	Installing adapter
B 28538	Installing adapter
C 302024	Removing/installing adapter
D 302025	Removing/installing adapter

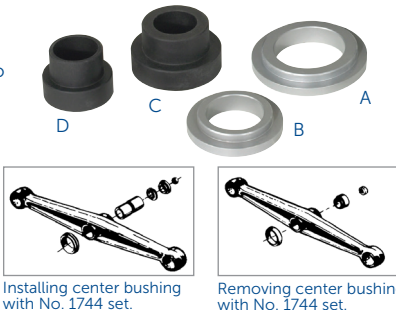

Installing center bushing with No. 1744 set.

Removing center bushing with No. 1744 set.

1763 Center and End Bushing Service Set

This set is required for bushing service on 500 and 700 series heavy-duty suspensions. It is intended for use with a 100-ton capacity shop press. It allows replacement of center and end bushings.

For 500 & 700 series suspensions. Use with a shop press.

Item No.	Description	Item No.	Description
A 208350	Adapter	C 28541	Adapter
B 208349	Adapter clamp		

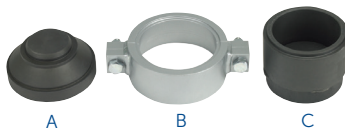

1764 Center and End Bushing Tool Set

This set is the answer for replacing center and end bushings on Hendrickson 340 and 380/440 series suspensions. The 1764 is for use with a 100-ton or larger hydraulic press. The press plate sits on the press bolster to provide a level, cradle-like surface for the beam to rest on during pressing.

For 340 and 380/440 series suspensions. Use with a shop press.

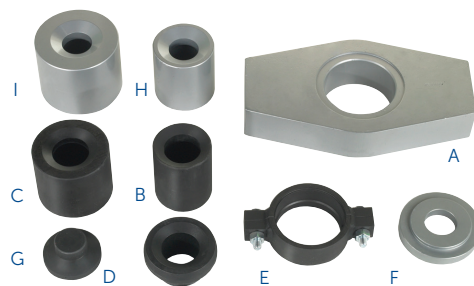

Item No.	Description	Item No.	Description	Item No.	Description
A 51100	Press plate	D 302030	Removing adapter	G 206457	Press adapter
B 302032	Removing adapter	E 42052	Inst. adapter clamp	H 302027	Removing adapter
C 302031	Installing adapter	F 206459	Clamp plate	I 302026	Installing adapter

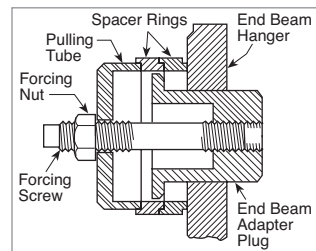

1748 End Bushing Adapter Puller Set for Hendrickson Truck Suspensions

This set contains everything needed to remove end bushing adapter plugs used on 400 series and the larger 460-520 series suspensions. The plugs have to be removed prior to end bushing replacement. The set is complete in a handy plastic case. For use with 1740 series tooling sets (order separately).

For servicing the 400 and larger 460-520 series suspensions.

Item No.	Description
A 207025	Spacers (3)
B 302592	Screw (7/8"-14)
C 302593	Screw (15/16"-12)
D 207027	Screw
E 207026	Plug gauge
F 207030	Hand tap (7/8"-14)
G 207031	Hand tap (15/16"-12)
H 207039	Nut assembly
I 302595	Receiving cup
J *221378	Hand tap (M30 x 2)
K *313342	Screw (M30 x 2)

*For use on 460-520 series adapter plugs (can be purchased separately and used with set No. 1745).



5130
1,000 lb. Capacity DriveMaster™ Driveline Lift

- Low profile of 7" and a Lift range: 7" to 30".
- Pivoting pump handle +/- 15° tilt in each direction
- Includes 553516 Differential Adapter
- ANSI/PALD

Specifications:

Overall Length – 43"
Overall Width – 30-1/4"
Max. Height – 30°
Min. Height – 7°



5078
Air-Assisted 2,000 lb. Capacity High-Lift Transmission Jack... or Trucks & Buses

- Foot-operated air pump enables the operator to effortlessly raise the transmission into place.
- Rugged, heavy wall tubing and oversized base for stability.
- A dedicated adapter for Allison 500- and 600-series automatic transmissions is included.
- Covered by OTC Lifetime Warranty®.

Specifications:

Min. height is 41-1/2" Backward tilt – 38°
Max. height is 65" Side tilt (side/side) – 14°
Forward tilt – 50° Leg width – 46"

1591B
10-Ton Combination Air Lift & Support Stand

- 40" removable handle and 8' air hose.
- Covered by OTC Lifetime Warranty®.

Specifications:

Capacity – 10 tons (at 200 PSI air)
Minimum height (unpinned, no extension) – 18-3/4"
Maximum height (pinned in top hole, with extension) – 50-1/2"
Stroke – 10-7/8"



5019A
2,200 lb. Capacity Low-Lift Transmission Jack

- Special mounting adapter fits popular Eaton® Fuller® RoadRanger® transmissions used on nearly all Class 7 and 8 heavy-duty trucks. Mounting plate angle is adjusted with the turn of a wrench.
- Swiveling pump handle permits ease of operation in restricted working spaces.
- Fast-acting pump quickly raises lifting arm.
- Includes No. 504231 adapter for Eaton® Fuller® RoadRanger® transmissions (also available separately).

Specifications:

Min. height is 8-1/4" Side tilt (either side) – 12°
Max. height is 36-1/2" Overall length – 52"
Forward tilt – 15° Overall width – 32-1/2"
Backward tilt – 20°

5091
HD Spindle Adapter

This low-lift transmission jack adapter holds the spindle assembly firmly in place during king pin service. It eliminates the need to completely disassemble the brakes to reduce spindle weight for handling. During service, the spindle assembly can be raised to a comfortable working height while replacing king pin bearings or bushings. Out patented design will work with standard HD truck bolt patterns and wheel stud sizes and adapts to most low-lift transmission jacks.

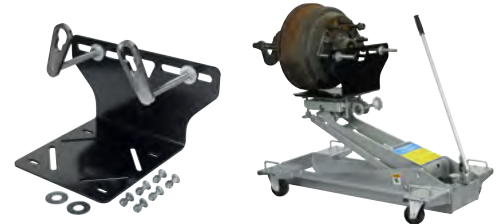

5091

Accessories for 5019A / 5078 / 1522A Transmission Jacks and 5130 Driveline Lift

558382 Auxiliary box adapter. Used with all.

561949 Light duty transmission adapters. Used with all.

528150 Eaton® "Lightning" adapter. Used with the No. 5019A transmission jack.

543284 Roadranger transmission Model series FRO-11210C to FRO-18210C that is equipped with an internal cooler. Used with the No. 5019A transmission jack.

49611 Eaton® Fuller® RoadRanger® auxiliary housing adapter. Bolts directly to the countershaft bearing caps to provide a stable platform for removing and installing the auxiliary housing.

553516 Differential Mounting Adapter. Mounts easily using existing bolt patterns. Fits the most common differentials currently in use on Category 7 and 8 Heavy Duty Trucks. Including: Eaton, Fuller, Rockwell, Meritor, Spicer, International, and Mack. For use on OTC (5019A – 553516 requires 565188 adapter) 5078 and Stinger 1522A Transmission Jacks.

314729 Allison 500/600 series automatic transmission adapter used with No. 5078 transmission jack.

540231 Eaton® Fuller® RoadRanger® transmission adapter

540232 Mack transmission mounting brackets. Provides a stable platform for Mack T200 series transmissions.



558382

561949



553516

528150



540231



543284

49611



540232

314729

CLUTCH / AIR LIFTS / POWER TRAIN LIFTS HEAVY DUTY TOOLS & EQUIPMENT



5018A Truck Clutch & Flywheel Handler

- Replaces 14" & 15-1/2" clutch assemblies weighing up to 250 lbs.
- 13" low point enables access below side faring.
- Linkage raises load from horizontal to vertical position.
- 360 degree swivel head.
- Includes a 2" spline shaft with a 1-1/4" pilot to aid alignment.
- Covered by OTC Lifetime Warranty®.

516160 Optional flywheel handling attachment

515686 Optional splined shaft, 1-3/4" dia. with 1-1/4" pilot

516159 Optional splined shaft, 1-3/4" dia. with 1" pilot



5015A Truck Clutch & Flywheel Handler

- Handles 14" and 15-1/2" clutch assemblies weighing up to 150 lbs.
- Lifting range of 9" to 37". Swivel casters provide easy maneuverability.
- Includes a 2" spline shaft with a 1-1/4" pilot to aid in alignment.

218174 Flywheel handling attachment for use on No. 5015 and 5015A only.

48625 Optional splined shaft, 1-3/4" dia. with a 1-1/4" pilot.

440533 Optional splined shaft, 1-3/4" dia. with a 1" pilot. Needed for clutch service on some Navistar 466 series engines.

314386 Optional 1-3/4" dia. alignment shaft extension. Used for 2-plate clutch of Navistar 466 series engine.



218174

314386



1520 10-Ton Capacity Lifting System (Includes two lifts)

- Mobile, tandem system is air-operated. This will handle your class 7 and 8 tractor lifting needs. No need to waste time re-blocking and making additional lifts for the clearance you need for under-vehicle service. Roll the system to the vehicle anywhere in the shop or outside on a level surface.
- Unique design provides lift from the tires, not the frame or axle members. Ideal for situations where limited ground clearance or a lack of clear access complicates lifting.
- Single controller operates both sides of the system for a smooth, level lift up to two full feet from the bottom of the tires to the ground. Units can double as support stands when retention pin is inserted.
- Covered by OTC Lifetime Warranty®.

Specifications:

Capacity – 10-tons (20,000 lbs.) (pair)
Air pressure – 150 psi
Lifting range – 0"-24"
Saddle width – 19-1/2" –

24" dia. rim sizes
Height – 53-1/4"
Width – 41-1/2"
Length – 39-1/2"

Power Train Lifts

- These lifts will handle engine and transmission assemblies, gas tanks, drive axle assemblies, engine/transaxle assemblies, electric vehicle batteries, and more.
- Scissors-type design allows access to all four sides of a component.
- Two independent adjusting screws tilt the table $\pm 15^\circ$ side-to-side, or fore and aft. Can be operated manually or with non-impact air wrench.
- 20" x 32" table.
- 8" swivel casters provide enhanced mobility under heavy loads.
- ANSI/PALD compliant.

5285 Power train lift (1,650 lb. Capacity)

Air / hydraulic operation – Foot control pump with hose allows movement around lift.

- Min. height is 31-1/2"; Max. height is 74-1/2".
- Footprint 33" wide x 48" long.

1595 Power train lift (2,500 lb. Capacity)

Powered by a quiet, 110V electric/hydraulic pump.

- Smooth, steady lifting and lowering motion controlled by hand-held remote.
- A 30 ft. long retractable extension cord is mounted to the frame.
- Min. height is 29"; Max. height is 80"
- Footprint 31" wide x 50" long.

5295 Powertrain Lift (1,760-lb capacity)

The sliding split table top design of this powertrain lift allows for separation of the engine/transmission assembly or hybrid engine/generator module, making service easier. The unique design also helps handle removal and installation of electric vehicle batteries, fuel tanks, suspension systems and other powertrain assemblies. A generous ground clearance allows for floor crane access while a low collapsed height aids in servicing large components while still on the lift. The table tilts to help properly align components to the vehicle during installation and threaded holes in the tabletop accommodate future adapters and powertrains.

- Similar to GM lift P/N GE-52200 and Honda lift P/N HON52200.

1590 10-Ton Air Lift

- Adjustable lifting saddles and an extra-wide stance for extra stability.
- Automatic mechanical safety catch engages in five height positions.
- Two large swivel casters and pneumatic tires make it easy to maneuver, even on loose gravel.
- Covered by OTC Lifetime Warranty®.

Specifications:

Capacity – 10 tons (at 200 psi air)
Air pressure – 100–200 psi
Lifting range – 13"–52"
Saddle spread – 29" – 41-3/4"

Saddle – 4" X 5-1/4"
Height – 67-1/2"
Width – 41"
Length – 36"
Distance from lift arm to floor support – 12-1/2"

572913

Optional saddle set for 1590. Saddle – 4" X 5-5/8"



5267

Lift Pad Adapters, set of two

The adapters sit on the hoist or jack saddle and seat inside frame holes on GM vehicles to prevent saddle lip from damaging frames or subframes. Similar to J-43625.



5285
extended

Casters provide a 9-1/2" clearance on lower frame



5285
collapsed



5295
extended



Convenient and secure storage space for large adapter & saddle.



5292
27.5-Ton Under Axle Jack

- Features class-leading 27.5 ton capacity
- Robust design with completely sealed piston.
- New lever design and pneumatic release valve for more precise release control.
- Power return allows lowering with no load.
- Includes two height adapters for flexibility.
- PALD compliant.
- Minimum retracted height (with saddle only): 8-1/4".
- Maximum extended height (with screw extended and large adapter): 21-3/8".
- Stroke: 4.9375".
- PSI range: 90 to 175.

1540
4-Ton Capacity Fork Lift Jack

- 8,000 lb. capacity with a low starting height of 2-5/8".
- Two-position lift pad permits handling of all lift truck configurations with flat or edged surfaces.
- Minimum low lift: 2-1/4".
- Maximum high lift: 16-1/4".
- Features include high-quality seals and high-strength steel construction.
- Handle stop makes for easy maneuverability.
- 30" long handle.

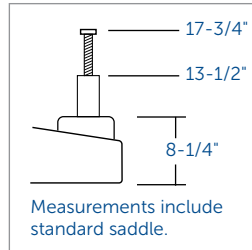
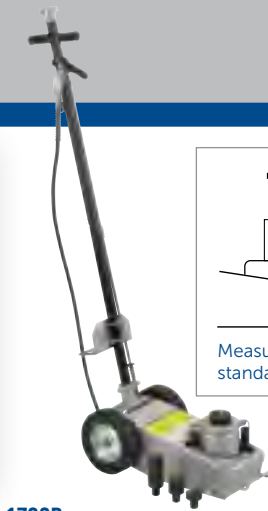

1788B
22-Ton Capacity Under-Axle Jack

- Improvements include advanced seal ring material and one-piece air piston air pump
- Long 49-1/2" T-handle lets you easily position jack under vehicles with long overhangs.
- One pull of the handle activates the self-retracting 22-ton capacity ram without having to crawl underneath the vehicle.
- Jack has large rubber-tired wheels.
- Lifting range:

3/4" saddle	Max. height 17-3/4"
1-15/16" saddle	Max. height 18-15/16"
3-7/8" saddle	Max. height 20-5/8"
- Cylinder stroke, 4-1/2"; extended screw length, 4-1/4"; PSI range, 90-145.

5214
4-Ton Capacity Fork Lift Jack

- 8,000 lb. capacity with a low starting height of 2-5/32".
- 10,000 lb. capacity (5 tons) when lifting from cylinder saddle— ideal for agriculture and industrial applications.
- Unique shape of primary saddle allows for handling of all lift truck configurations with flat or edged surfaces.
- Features include high-quality seals, chrome-plated internal components, and high-strength steel construction.
- Secondary lifting surface feature.
- Complies with ASME-PALD.
- Lifting Height: 2-5/32 – 17-15/16".



215009*

In-line oil lubricator. Add to air line to meter precise flow of lubricant to air motor. Has 1/4" NPT fitting. *Not included, order separately. Prevents harmful contamination caused by moisture in the air line!



5093B
3-Stage Under-Axle Jack

- Three-stage lift capacity 22.1 T, 38.5T, and 71.5-tons. Ideal for lifting loaded trailers, buses, and other Class 7 & 8 vehicles.
- Piston and cylinders are made from chromium molybdenum vanadium steel for durability and then liquid nitrided to prevent rust and seizing.
 - Features a high load-approach speed.
 - Air-driven cylinder with pressure control knob for maximum user safety.
 - 4-position handle: horizontal, 45 degrees, vertical, or collapsed.
 - 7-inch minimum height for low clearance vehicles.
 - Comes complete with a 3-15/16 in. (100 mm) lifting extension.
 - Complies with ASME / PALD test requirements.

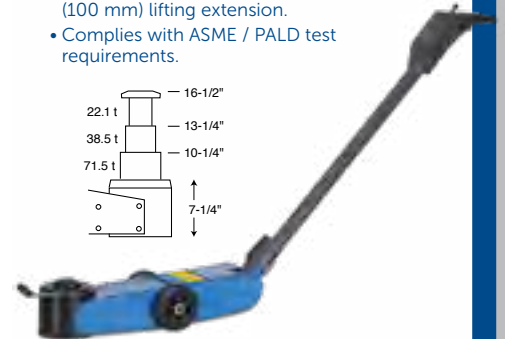
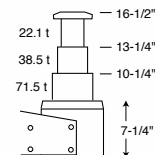

SERVICE JACKS

HEAVY DUTY TOOLS & EQUIPMENT

5-Ton and 10-Ton Service Jacks

- A built-in safety overload prevents using the jack beyond its rated capacity.
- Convenient foot pedal speeds the lifting operation. Handle lock and release control are located on top of the handle. Handle can be locked into any position from vertical to horizontal.
- Both models have a spring-loaded 40" handle.

1505B 5-ton service jack

1510B 10-ton service jack



20-Ton Capacity Service Jack

- Low-profile stance and extended height add to versatility.
- Wheels and swivel casters feature internal bearings.
- Either the foot pedal or jack handle may be used for pumping action. Counter-balanced, spring-assisted handle has a three-position lock.

1512 20-ton service jack

Specifications	1505B	1510B	1512
Capacity	5-ton	10-ton	20-ton
Lifting range	6" to 22"	6-1/4" to 22"	7-1/2" to 24"
Saddle dia.	5-1/8"	6"	7-1/2"
Overall reach	47"	51"	97"
Frame height	7-3/4"	9-3/4"	10-1/4"
Handle Length	43"	43-1/4"	42"
Floor space	14-3/4" to 56"	18" to 60"	18-1/8" to 61-3/8"

5-Ton and 10-Ton Air/Hydraulic Service Jacks

- Bring the versatility of air-assist operation to your shop's lifting tasks.
- Huge front wheels mounted in bearings provide trouble-free service life. Rugged steel frame members.
- Rear swivel casters make spotting the jack easy. Spring-loaded handle may be locked in three positions, from horizontal to vertical.

1507B 5-ton air/hydraulic service jack

1511B 10-ton air/hydraulic service jack

Specifications	5206	5210
Capacity	6-ton	10-ton
Min. Height	6-11/16"	6-11/16"
Max. Height	22-13/16"	23-13/16"
Overall length	87"	99-1/2"
Overall width	16-5/8"	16-5/8"
Handle length	39-3/8"	39-3/8"

Specifications	1507B	1511B
Capacity	5 ton	10 ton
Air pressure	80-120 PSI	80-120 PSI
Lifting range	5-7/8" to 22"	6-3/8" to 22"
Saddle dia.	6-5/8"	5-3/4"
Overall reach	87"	90"
Frame height	8"	10"
Handle length	40"	45"



SEE ADDITIONAL PRODUCTS IN THE EQUIPMENT SECTION OF THIS CATALOG. PAGES 204 – 207.



6000 lb. Revolver® Diesel Engine Stand

- 96-to-1 ratio worm and gear set rotates components 360°; handle locks in any position.
- Integral 12-ton jack raises the work to provide the swing radius needed for clearance.
- Two front wheels and two rear casters provide mobility.
- Universal adapter assembly permits use with a wide variety of mounting plates.
- Covered by OTC Lifetime Warranty®.

1750A Revolver diesel engine stand with No. 205061 universal engine adapter assembly.

1750 Engine stand without universal engine adapter assembly. Revolver® Engine Adapter Plates

You can order just the plates you need for the engines you work on. The universal adapter assembly is required for mounting all plates to the stand.

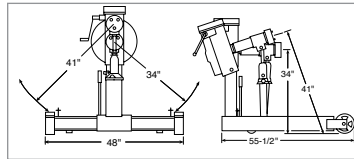

Engine Plates	
205061	Universal Adapter Plate Assembly. Included with 1750A engine stand. (Must be used with all plates below.)
J-29109-J	Adapter plate to accommodate adapters for Kent-Moore engine stand.
Detroit Diesel	
205058*	For Detroit engines: 53 series in-line 6 cyl., 6V & 8V; 71 series in-line 6 cyl., 6V, 8V, & 12V; 92 series 6V & 8V; 8.2 liter V-8.
52871*	For coach 6V and 8V series 71 Detroit Diesel.
218504*	For Detroit series 60 in-line 6-cylinder engines.
Detroit Allison	
208160*	Allison transmission mounting plate for transmission Nos. AT500, MT600, MT 6-speed, VH, VS, and V730.
61373*	Allison transmission adapter plate for transmission series HT-750, CLBT, HT-740D, CR/DR, and HT-750CT.
Cummins	
205059*	For Cummins engines: All NH, NTC, NTE, N14 855 series in-line 6 cyl; 378 series V6; 504, 555, & 903 series V8; KT 1150 series in-line 6 cyl., L10.
61405*	For Cummins L-10 and M11 series engines. Plate attaches to the left side of engine for complete tear down.
218098	For Cummins "B" series 5.9L in-line 6 cyl. engines.
218099*	For Cummins "C" series 8.3L in-line 6 cylinder engines.
Caterpillar	
205060*	For Caterpillar engines: Nos. 1673, 1674, 1693, 3306, & 3406 in-line 6 cyl.; Nos. 1100, 3208, and 3408 V8.
217687*	For Caterpillar 3114, 3116, and 3176 in-line 6 cylinder and C12 engines.
Mack	
205101*	For Mack engines: All 672, 673, 675, & 711 series in-line 6 cyl.
206629*	For Mack engines: V8 1000, E6, & E7 in-line 6 cyl.
528858*	For Mack 865, and 868.
International Harvester	
206386*	For International Harvester engines: DT-466 (2004 & Earlier), DT-360, DT408, 7 530 in-line 6 cylinder; DV-550, MV-404, MV-446, V304, V345, V392, 4-152, 4-196, 4-194; 9.0 liter 7 T444E V8; and Ford 6.9L, 7.3L DIT.
528856*	For IH300 & 400 Series.
528868*	For International VT365.
Ford	
61681*	For mounting Ford 6.6L/7.8L engines.
206386*	For Ford 7.3 engines.
Volvo	
528853*	For Volvo TD67 and TD71 engines.
John Deere	
528859*	For JD 400 and 500 engines.
528861*	For JD Powertech 4.5L & 6.8L.
528863*	For JD 8995 V6, must be used with 528859.



*NOTE: Must be used with 205061 univ. adpt. plate assembly. Each engine mounting plate includes all the necessary hardware and an engine application chart.

ENGINE / JACK STANDS HEAVY DUTY TOOLS & EQUIPMENT



1735B

1735B 2,000 lb. Capacity Heavy-Duty Motor-Rotor® Repair Stand

- Handles a wide variety of engines, transmissions, torque converters, and rear axles from trucks, tractors, and construction machinery.
- The 50:1 ratio gearbox allows full rotation of mounted unit with just a turn of the crank and locks in position. Easily maneuvered when loaded.
- To ensure engine stability in all positions, this repair stand is equipped with a positive-crank handle locking mechanism.
- Twin-post design, featuring laterally adjustable, 3 position outboard support; provides an extremely stable work-holding unit.
- Locking rear wheels anchor stand in position.
- Covered by OTC Lifetime Warranty®.

206391 6.0L and 6.4L Ford engine adapters.

(Works with both the OTC 1735, 1735A and 1735B.)

206392 Ford 6.7L Engine Adapter for 1735B HD Rotor Repair Stand.



1735B with engine

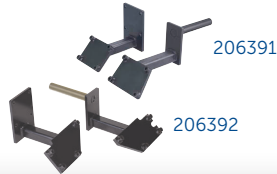
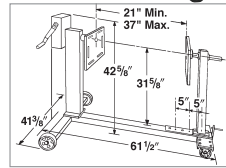

206391

206392

1783 Heavy-Duty 20-Ton Capacity Adjustable Support (One only)

- Designed for the really big service jobs. Rugged steel construction, and large 15-1/2" square base will satisfy support requirements up to 40,000 lbs.
 - Features include 4-point adjustment. Height range is 15-1/4" to 24". Saddle diameter is 6".
 - Covered by OTC Lifetime Marathon Warranty®.
- Note: Recommend use in pairs.



1778B 12-Ton Capacity Low Profile Jack Stand (One only)

- Spun steel base won't dig or sink into asphalt or sand.
 - Height range of 19" to 29-1/2".
 - Covered by OTC Lifetime Warranty®.
- Note: Recommend use in pairs.



1779B 12-Ton Capacity High Profile Jack Stand (One only)

- Spun steel base won't dig or sink into asphalt or sand.
 - Height range of 33-3/4" to 44-1/4".
 - Covered by OTC Lifetime Warranty®.
- Note: Recommend use in pairs.



Extension Tubes for 1778B and 1779B Jack Stands

- 543751** Extension Tube Height range of 19" to 29-1/2"
- 543752** Extension Tube Height range of 33-3/4" to 44-1/4"

543751

543752



3- and 6-Ton Capacity Ratcheting Jack Stands

- Jack stands feature a formed steel frame for strength and long life, and rolled base edges that resist sinking into soft ground or asphalt.
- Recessed column saddle for acceptance of vehicle panel rail (pinch weld).
- Dual purpose handle serves as carrying handle and column release.
- Investment cast rack bar for long life strength.
- Covered by OTC Lifetime Warranty®.

1736A Pair of 6-Ton Jack Stands. Height Range of 15-1/2" to 24-1/2".

1733A Pair of 3-Ton Jack Stands. Height Range of 12-1/2" to 18-1/2".



5373

OTC Stinger 3, 4, 6 and 12-Ton Jack Stands

- Formed and welded steel base for strength; self-locking ratchet handle cannot be released under load. Durable baked enamel finish resists corrosion.
- Stands conform to ANSI PALD load rating standard; factory tested before shipment.

5372 Pair of 3-ton jack stands. Base: 8-1/4" x 7-1/2". Height range: 12" to 17-11/16".

1796 Pair of 4-ton jack stands. Base: 11-7/16" x 10-3/8". Height range: 15-5/16" to 23-13/16".

5373 Pair of 6-ton jack stands. Base: 11-9/16" x 10-3/8". Height range: 15-5/8" to 23-11/16".

1784D Pair of 12-ton jack stands. Base: 12-1/8" x 10-7/8". Height range: 17-1/2" to 27-1/2".



1780 22-Ton Capacity Jack Stands

- Height range is 13-7/8" to 19-7/8".
- Saddle size 3" x 3-3/4".
- Pin-style (non-ratchet) three positions, 3" intervals.
- Reinforced collar to meet newest ANSI PALD test standards.
- 11" flat base prevents sinking into the surface.



1774B 10-Ton Capacity Ratcheting Jack Stands (pair)

- These ratcheting jack stands are highest quality steel and factory tested to ANSI PALD standards.
- The form-fit saddle design and 12" x 14" base ensures stability.
- Height range is 20" to 31-1/2".

OTC 9300 STINGER SERIES BOTTLE JACKS GIVE YOU LIFTING RANGE FROM 2 TO 50 TONS.

- Forged base and cylinder to ensure strength and eliminate leaks.
- Chromed pump piston and ram for additional rust resistance.
- In-line design for increased ease of use in positioning and operation.
- Includes free seal kit with each unit to extend product life.
- ANSI/PALD compliant.



OTC 9300 Stinger Series Bottle Jacks

Cap. (tons)	Stroke	OTC No.	Retracted Height min.	Length of Screw Extension	Height with Screw Extension	Pump Strokes to Extend Piston One Inch	Saddle Dia.	Base Size	Carry Handle	Weight
2	4-5/8"	9302	7"	2-3/8"	14"	8	13/16"	4-5/16" x 2-9/16"	No	5.7 lbs.
3	4-1/2"	9303	7-1/2"	2-9/16"	14-9/16"	13	15/16"	4-9/16" x 2 7/8"	No	7 lbs.
5	4-13/16"	9305	7-13/16"	3"	15-5/8"	20	1-1/8"	5-3/16" x 3"	No	9 lbs.
8	4-15/16"	9308	7-13/16"	3"	15-3/4"	21	1-3/8"	6" x 3-9/16"	No	13.2 lbs.
12	6"	9312	9-3/8"	3-1/4"	18-5/8"	21	1-3/4"	6-9/16" x 4-3/16"	Yes	18.9 lbs.
12	3-11/16"	9314	7-1/16"	2-7/8"	13-5/8"	21	1-3/4"	6-9/16" x 4-3/16"	Yes	16.1 lbs.
20	6-7/8"	9320	10-5/8"	2-15/16"	20-7/16"	28	2-1/8"	7" x 4-11/16"	Yes	28.6 lbs.
20	3-7/16"	9322	7-3/16"	1-11/16"	12-5/16"	25	2-1/8"	7" x 4-11/16"	Yes	22.5 lbs
30	6-5/8"	9330	11"	N/A	17-5/8"	41	2-1/2"	7-11/16" x 6"	Yes	43.2 lbs
50	7-3/16"	9350	11-3/4"	N/A	18-15/16"	74	2-1/2"	8-11/16" x 7"	Yes	76.5 lbs.



5213A



5221A



5213TA

Bottle Jacks

- Base, pressure cylinder, and oil reservoir form one internal part, which results in a stronger jack.
- Piston never contacts cylinder, so pressure will be absorbed and not damage jack if vehicle tilts.
- The No. 5213T is telescopic, allowing for very low initial height with high lifting.

5213A – 12-Ton Bottle Jack.

5221A – 20-Ton Bottle Jack.

5213TA – 12-Ton Telescopic Bottle Jack.

Bottle Jack Dimensions

Jack	A	B	C	D	E
5213A	17-3/4"	8-7/8"	5-1/4"	3-1/2"	–
5221A	18-1/32"	9-1/4"	8-3/4"	3-5/8"	–
5213TA	22-5/16"	9-7/8"	–	–	12-7/16"

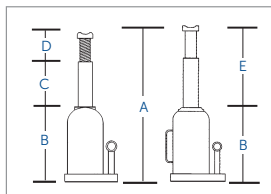

Air/Hydraulic Bottle Jacks

- Operate manually or pneumatically, 100 PSI minimum air pressure required.

4313C
12-ton air-assist bottle jack; lift range 9-1/2" to 18-3/8", stroke 6-1/8".

4321C
20-ton air-assist bottle jack; lift range 9-7/16" to 17-11/16", stroke 5-7/8".



4313C

1734A Heavy-Duty Wheel Step

- Tire-mounted wheel step provides quick, easy access to under-hood components.
- Fits heavy-duty vehicles (Class 7/8).
- Installs in seconds; adjusts to fit 22-1/2" to 24" wheel sizes and folds for easy storage.
- 300 pound capacity.
- Non-skid platform surface.



Shown folded

WHEEL SERVICE HEAVY DUTY TOOLS & EQUIPMENT

5017A Brake Drum Dolly

- Remove, install, and transport truck brake drums without physically having to lift them.
- Works on 15" and 16-1/2" drums found on most Class 7 and 8 tractor and trailer brake systems.
- Heavy-gauge steel construction, ten-inch pneumatic tires, and adjustable handle.
- Covered by OTC Lifetime Warranty®.



1543 Brake Drum Dolly

- Removes, installs, and transports truck brake drums without physically having to lift them.
- Works on all 15" and 16-1/2" drums found on most class 7 and 8 tractor and trailer brake systems.
- 6" height adjustment aids installation.
- Heavy-gauge steel construction, 8" tires, and 36" handle.

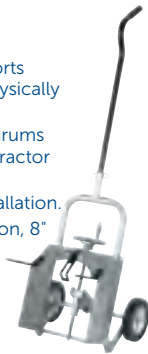

Easy Lever Wheel Dollies

- Gives technicians the leverage they need to easily remove or install truck tire-and-wheel assemblies.
- Heavy-duty construction capable of toting 300 pounds.
- Onboard rollers that make stud-hole alignment a snap.
- Spring-loaded kickstand for handy parking.
- Two models that, together, can accommodate tire diameters from 24 to 48 inches.
- Rugged tubular steel construction.

5096A Heavy-duty Easy Lever Wheel Dolly. With a width of 26", this dolly handles tire diameters of 36" to 48".

5095A Easy Lever Wheel Dolly. With a width of 22", this dolly handles tire diameters of 24" to 36".



20-Ton Truck Ramps

- Long, retractable T-handle enhances mobility.
- Non-skid rubber matting prevents slippage during use.
- Durable, heavy-duty rubber wheels.
- Capacity per pair is 20 tons
- Covered by OTC Lifetime Warranty®.

5268 – 20-ton truck ramps handle up to 10" tread width.

5269 – Wide 20-ton truck ramps handle up to 16" tread width

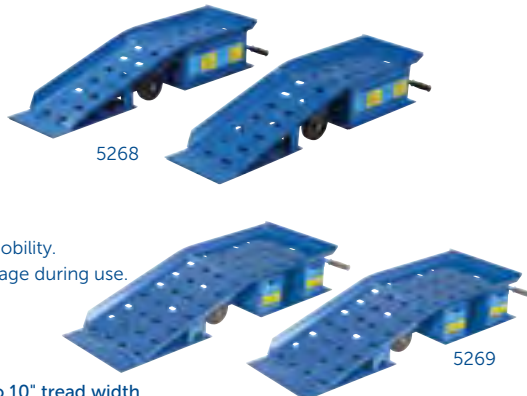

5268

5269

Model	Frame Height	Frame Width	Frame Length	Wheel Diameter	Handle Length
5268	9-1/4" (23.5 cm)	13-1/2" (34.29 cm)	47" (119.38 cm)	5" (12.7 cm)	33" (83.82 cm)
5269	9-1/4" (23.5 cm)	18-1/4" (46.36 cm)	47" (119.38 cm)	5" (12.7 cm)	33" (83.82 cm)

5090 Back Buddy™ II

- Remove, transport, service, and install heavy truck brake drums and hub assemblies.
- Fast-motion ratcheting jack with 14" of vertical lift.
- Pneumatic rear tires.
- Tilting mechanism to achieve the exact angle necessary for precise reassembly.
- Fold-down handle for open access to the work area.
- Onboard lube tray and toolbox.
- An array of optional adapter sets capable of grabbing almost any truck hub assembly or brake drum, inboard or outboard.

Adapter Sets (sold separately)

513926 10 stud inboard hub & drum assemblies – 335 mm.

513927 10 hole outboard drums – 3/4" thick back plates

513925 5 and 6 spoke wheels

514644 8 stud inboard hub & drum assemblies

514645 8 hole outboard drums

514646 6 stud inboard hub & drum assemblies

514647 6 hole outboard drums

514648 Humvee/Hummer geared hubs



5105B 1,100 lb. Capacity High-Lift Dual Wheel Dolly

- Effortless air-powered hydraulic lift system for a variety of applications.
- 0 to 42" lifting range.
- Six-inch lateral adjustment.
- Tilt adjustment of +15° to -8° ensures easy alignment.
- Features four swivel casters, two locking, for enhanced mobility.



1770A 1,500 lb. Dual Wheel Dolly

- Hydraulic jack provides almost 5" of lift and tilts wheel assembly 4° to prevent damage to wheel seal.
- Independent lifting rack provides maximum stability; rollers won't catch on load.
- Swivel casters for easy maneuverability.
- Floor space is 45" by 41".
- 6' chain holds load in place.
- Covered by OTC Lifetime Marathon Warranty®.



1769A Truck Dual Wheel Dolly

- This 1,500 capacity dolly will remove, transport, and replace dual wheel and tire assemblies without strain or struggle.
- Swivel casters, 3-1/2" front and 3" rear, provide easy maneuverability.
- Floor space is 43" by 42".
- No. 1769A hydraulic jack provides over 6-1/2" of lift and tilts wheel assembly 7° to prevent damage to wheel seal.
- Includes a 6' support chain to hold load in place.



5713 Tire Bead Seater

The Tire Bead Seater is used when a tire, new or used, is mounted on a wheel and the tire bead does not touch both sides of the wheel, making inflation possible. The air trigger on this tool expels a tremendous burst of air that inflates the tire to seat it to the wheel rim. This allows the tire to be inflated to the recommended pressure through the tire valve.

- The Tire Bead Seater is equipped with unique configurations that enhance ease of use, productivity and safety for technicians looking to get the job done right every time.
- Unlike other options out there, the Tire Bead Seater's ASME certified 13-gallon tank is designed with a nozzle and valve connected via hose assembly, giving the user more control rather than requiring them to hold the weight of the tank.
- The trigger style discharge valve allows for optimum airflow control while allowing both hands to firmly hold the nozzle/valve assembly, critical for effective and safe use. Wheels and handle function in either the vertical or horizontal position for easy mobility and storage.
- Unique nozzle design significantly reduces "blowback recoil" and contains discharge holes strategically placed for optimum inflation of a wide range of the tire sizes and wheel diameters.
- Air valve included for filling tank, which also provides compressed air for filling the tire while seating the bead, optimum for on-the-road service.

All these unique features combine to provide an industry leading bead seater with multiple tire capacity (up to 5 tires) on one tank fill.



5702 Tire Bead Seater

The 5702 OTC Tire Bead Seater provides many of the great features of it's 5713 big brother, at a more economical price!

- The trigger style discharge valve allows for optimum airflow control while allowing both hands to firmly hold the tank/valve assembly, critical for effective and safe use.
- Unique nozzle design significantly reduces "blowback recoil" and contains discharge holes strategically placed for optimum inflation of a wide range of tire sizes and wheel diameters.
- Inline design allows for a comfortable distance from the tire and wheel while seating.
- ASME approved 2-gallon tank with inlet valve, pressure gauge, and relief pressure valve for safety.



5700A Accessory Tire Bead Seater

- Provides the ability to control the blast with both hands firmly on the nozzle assembly, increasing effectiveness and safety.
- Includes all the fittings to adapt the hose to most surge tanks found on tire changers. A tank hook is also included to hang the nozzle when not in use.
- Long 6-1/2' hose will reach all positions on the tire.

5735-PACK Tire Spoon Pack with Hang Rack

An upgraded pack of popular tire spoons features the 35" Double End Tire Spoon with Grip Grooves (5735 35G), 35" Curved/Flat Tip Curved Tire Spoon (5735-35) and 30" Curved Tire Spoon (5736-30), along with a FREE rack (5715) that can be hung on a toolbox or wall for easy organization.

*Tool chest not included



5715 Tire Spoon Rack

- Designed to hold OTC Tire Spoons by the handle upset.
- Also holds tools with 3/4" or smaller diameter shafts.
- Can be hung on end of tool box or mounted to the wall via holes on 16" center.



5789-PACK Tire Service Display

Includes 23 popular tools for changing a tire:



Part Number	Qty
5716	1
5720	1
5724	1
5728	1
5729	1
5731	1
5732	1
5733	1
5735-35	2
5735-42	2
5735-42K	1
5736-24	1
5736-30	1
5737-30	1
5739-24	1
5739-30	1
5758	2
5047LP	1
5789ID-520	1
5789ID-1032	1
5700-DISPLAY	1

5700-DISPLAY

Hammer & Tire Service Display Rack

- Designed to display various products in the framed rack, complete with removable rear sign holder.
- Sturdy display framed with heavy 5/16" rod with heavy steel base eliminates tipping.
- Black powder coat finish for a rust free, durable finish.
- Contains 2" x 2" = 52 slots and 2" x 4" = 6 slots.
- Assembled dimensions; W 18.5", D 19", H 44".



5693 Dual/Single Wheel Separator

Quickly separate rusted, frozen or seized outside dual wheels or single wheels from the wheel hub. The unique outer drive hook has an offset handle to easily align the tool on the rim to break wheels loose, with a flat side to eliminate turning during use. Outer drive hook has two grooves for 16" - 17" wheels and 19.5" to 24.5" wheels. Force is applied directly to the wheel rim and not the wheel lip, preventing damage and bending of the wheel.

Includes four adapters to fit most wheel shapes and sizes: Dual wheel outer, long cupped dual wheel inner, short cupped single wheel and flat.



TIRE SERVICE HEAVY DUTY TOOLS & EQUIPMENT



Convex Slip Head - Unique "Convex Slip Head" curved design allows the spoon to slide easily into the tire bead while the spoon bump limits the depth for quick-and-easy operation.



Grip grooves - Eliminate spoon slippage on the wheel rim while mounting or demounting the tire. The grooves also limit the depth of the spoon to help eliminate pinching tire tube applications.

5716	HD Sliding Tire Spoon - 38" extends to 52", 3/4" diameter. Inner slide bar provides hammer action to easily insert and remove the spoon.	
5716G	HD Sliding Tire Spoon with Grip Grooves 38" extends to 52", 3/4" diameter. Inner slide bar provides hammer action to easily insert and remove the spoon.	
5720	Sliding Dual Tire Spoon 35" and 3/4" diameter. Unique configuration provides mount and demount heads on either end with the aid of a slide hammer mounted mid bar, allowing for hammering either end in or out of the tire bead. Twist-lock feature locks 3.5 lb. slide weight in position.	
5724	Extending Tire Spoon 22" extends to 34", 3/4" diameter. Twist-lock feature allows the spoon to be extended to any length and locked into position with a twist of the collar.	
5734-18	Tire Machine Spoon, Double End , 18" Has a curved end and a bent tip end for starting the bead on a tire changing machine.	
5734-18G	Tire Machine Spoon, Double End with Grip Grooves , 18" Has a curved end and a bent tip end for starting the bead on a tire changing machine.	
5735-18	Double End Curved & Flat Tip Curved Tire Spoon , 18" Double end curved tire spoon. Handle knob enables easier spoon pick up. 3/4" diameter.	
5735-18G	Double End Tire Spoon with Grip Grooves , 18" Double end curved tire spoon. Handle knob enables easier spoon pick up. 3/4" diameter.	
5735-35	Double End Curved & Flat Tip Curved Tire Spoon , 35" Double end curved tire spoon. Handle knob enables easier spoon pick up. 3/4" diameter.	
5735-35G	Double End Tire Spoon with Grip Grooves , 35" Double end curved tire spoon. Handle knob enables easier spoon pick up. 3/4" diameter.	
5735-42	Double End Curved & Flat Tip Curved Tire Spoon , 42" Same great design as the original double end mount/demount tire spoon, but in a 42" length for added leverage. 3/4" diameter.	
5735-42K	Double End Tire Spoon with Kick Start , 42" Includes kick loops to allow the spoon to be forced into tight bead locations with the help of foot pressure. 3/4" diameter.	
5736-18	Curved Tire Spoon , 18" Handle knob enables easier spoon pick up. 3/4" diameter.	
5736-18G	Curved Tire Spoon with Grip Grooves , 18" Handle knob enables easier spoon pick up. 3/4" diameter.	
5736-24	Curved Tire Spoon , 24" Handle knob enables easier spoon pick up. 3/4" diameter.	
5736-24G	Curved Tire Spoon with Grip Grooves , 24" Handle knob enables easier spoon pick up. 3/4" diameter.	
5736-30	Curved Tire Spoon , 30" Handle knob enables easier spoon pick up. 3/4" diameter.	
5737-30	Flat Tip Curved Tire Spoon , 30" Handle knob enables easier spoon pick up. 3/4" diameter.	
5739-24	Curved Shank Tire Spoon , 24" The curved shank allows improved access for the spoon head around the tire bead or wheel rim. Handle knob enables easier spoon pick up. 3/4" diameter.	
5739-30	Curved Shank Tire Spoon , 30" The curved shank allows improved access for the spoon head around the tire bead or wheel rim. Handle knob enables easier spoon pick up. 3/4" diameter.	



5789ID-1032

5789ID-520

Tire Service Hammers, Indestructible Handle

- Indestructible handle - never needs replacement!
- Ergonomic rubber grip handle reinforced with steel bars resists breaking while absorbing impact and vibration.
- Drop-forged head is induction-hardened for long life, and contains steel locking plates that are specially bonded to ensure the head never becomes loose.
 - Use top hook as a wheel tipper; sledge end hook to drag tire into position.
 - Bead breaking wedge has grooves and a convex shape to help drive tire lube into the bead.

5789ID-520 5 lb. head, handle length 20", total weight 7.3 lbs.

5789ID-1032 10 lb. head, handle length 32", total weight 14.4 lbs.



5728 Tire Bead Breaker

- This tool will break beads in applications where other bead breakers have failed. A tire with a very weak or damaged sidewall due to a zipper rupture, or driven too far while flat, can be near impossible to break the bead with conventional bead breakers. Other applications like extremely soft sidewall tires, such as ATV tires, is where this unique bead breaker works and other do not.
- Unique head is designed to provide a large striking area for all angles, while providing the mass needed to break the tire bead.
- This design puts the force exactly where it's required and eliminates the possibility of accidentally hitting the wheel, problems typically encountered while using larger swing hammer style bead breakers.



5047LP Lug Nut Cap Remover Locking Pliers

- Designed to remove lug nut caps found on heavy duty truck and trailers quickly and easily without damage. Caps can be easily damaged by prying or using standard cap removers.
- Locking pliers design with specially coated jaws apply maximum grip on the lug nut caps without damage.



5727 Sliding Bead Breaker

- The unique wedge design allows for consistent and accurate impact angle without adjusting the handle angle.
- The split head design provides wider tire force area while reducing drag on the wheel rim.
- Foot loops allows for extra foot pressure for bead breaking with fewer strikes.
- The head is also designed to tip tires from either side of the wheel. Includes wheel tipping slots to easily flip 250 lb. tires without hurting your back.
- Hammer shaft does not fall out of hammer body like competitive units.

5047 Lug Nut Cap Remover

- Chrome-plated lug nut caps found on many heavy-duty trucks and trailers can be tough to remove, and they're easily damaged if you pry them off or use an ordinary cap remover. This tool avoids those problems. It is ruggedly built and features specially coated jaws that won't slip off the caps, no matter how much squeezing force you apply.
- Features cushioned handles.

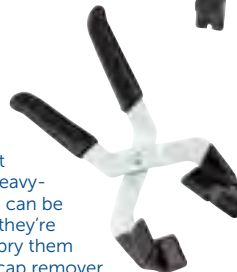

5752 Wheel Loader & Tipper

- The new ergonomic wheel loader and tipper integrates two very helpful tools into one.
- The wheel loader feature allows a technician to lift various sizes and types of wheels and tires in and out of a truck bed.
- The wheel tipper feature allows the technician to flip a wheel over during tire service, or just tip up a wheel and tire to move.
- Both of these features allow the technician to easily and safely service and lift wheels by eliminating the need to bend over to lift, dramatically reducing the risk of back injury.
- Works on steel or aluminum wheels, inflated or deflated.



5750 Wheel Tipper

- This ergonomic wheel tipper allows the technician to flip a wheel over during tire service, or just tip up a wheel and tire to move.
- Allows the technician to easily and safely service wheels by eliminating the need to bend over to lift, dramatically reducing the risk of back injury.
- Works on steel or aluminum wheels, inflated or deflated.

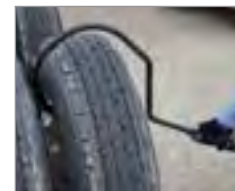

5729 Outside Dual Wheel Bead Breaker

- Breaks the inner bead on the outside tire without removing the wheel from the truck.
- Unique design places pressure in the exact location required to quickly and easily break the inner bead.
- Simply pull up on the handle and the bead is forced off the wheel rim.



5745 Hands Free Air Chuck

- Perfect for applications where the tire valve is facing the floor while seating the tire bead, such as most dual wheel configurations.
- Hooks on the top bead seat of the wheel and the spring pressure holds the chuck on the tire valve pointing to the opposite side.
- Ball valve included to allow inflation only when needed.
- Allows for safe tire inflation when used with a 6' to 8' inflation hose.



HEAVY DUTY TOOLS HEAVY DUTY TOOLS & EQUIPMENT



5747 Tire Valve Stem Punch Kit

- Quickly and easily remove old valve stems from a wheel with a swing of a hammer.
- Simply place the punch tip on the inside of the valve stem and strike the punch to force the old valve stem out of the wheel.
- The unique punch tip is heat treated and shaped to remove all types of valve stems, including 10mm nickel plated, steel, and brass.
- Works on 412, 413, and 418 valve stems.
- Includes hand protecting grip with interchangeable 5" and 8" punch adapters for car and truck wheel applications.

5747-2 Tire valve punch tip, 5"

5747-3 Tire valve punch tip, 8"



5731 Tire Bead Locking Pliers

- Prevents the tire from slipping while mounting the top bead.
- Quick and easy universal clamping design.
- Rugged rubber coated jaw to protect wheel finish.
- Prevents tire from contacting costly TPM Sensors.



5732 Tire Spoon Holding Pliers

- Tire Spoon Holding Pliers is the 3rd hand needed to ease mounting and demounting of tires with tire spoons.
- Quick and easy universal clamping design.
- Rugged rubber coated jaw to protect wheel finish.



5733 Tire Bead Wedge Pliers

- Tire Bead Wedge Pliers keeps the tire in the bead drop area to ease mounting and demounting of larger truck and agricultural tires.
- Quick and easy universal clamping design.
- Rugged rubber coated jaw to protect wheel finish.



Accutorq™ Clikker Torque Wrenches

- These precision torque wrenches make a loud click when you've reached the torque setting. They feature ratcheting heads, all-metal construction, permanently roll-marked scales, and soft-grip rubber handles that enable you to firmly grasp the wrench for right- or left-hand torquing.
- Includes molded plastic case.
 - One-year warranty.

Tool No.	Torque Range	Graduations	Square Drive	Length
7378	50–250 in. lbs. (68–339 N•m)	2 ft. lbs.	1/2"	19-3/8"
7379	100–600 in. lbs. (136–813 N•m)	10 ft. lbs.	3/4"	42-1/4"



7367 Torque Multiplier, 1100 lb-ft

- Drive Input; 1/2", 365 lb-ft Max
- Drive Output; 3/4", 1100 lb-ft Max
- Head Width; 2.9", 3.3:1 Ratio
- Reaction Bar; 13-3/4"
- Includes reaction foot.
- Note; frictional gear loss = 6%



7368 Torque Multiplier, 2200 lb-ft

- Drive Input; 3/4", 730 lb-ft Max
- Drive Output; 1", 2200 lb-ft Max
- Head Width; 3.6", 3.3:1 Ratio
- Reaction Bar; 15-5/8"
- Includes reaction foot.
- Note; frictional gear loss = 6%



5082 Wheel Tipper

- This heavy-duty wheel tipper makes handling those hard- to-manage truck tires easy. To use the wheel tipper, simply deflate the tire and break the bead, then hook the wheel tipper to the rim of the wheel. The wheel tipper makes an otherwise tough task effortless.
- Designed for both aluminum and steel wheels won't damage wheel rim.



1819, 1820

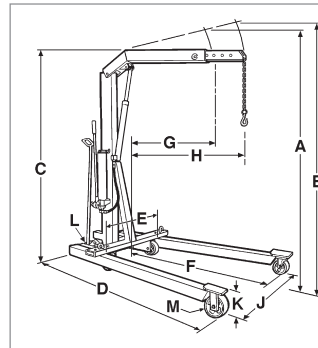

Specifications	1819	1820
Cap., boom retracted	2,200	4,400
Cap., boom extended	1,650	3,300
A Max. boom height, boom retracted	107"	111"
B Max. boom height, boom extended	117"	122"
C Overall height, boom horizontal	80"	82"
D Overall length	83"	89"
E Minimum throat width	24"	25"
F Inside leg length	54"	57-1/2"
G Effective boom reach (retracted)	33"	35-1/2"
H Effective boom reach (extended)	48"	50-1/2"
J Inside leg width (3-position)	24", 36" 48"	26", 40" 52-1/2"
K Leg height	8"	9-1/2"
L Dolly wheel diameter	5"	5"
M Wheel diameter	6"	8"
Height, folded	79"	86"
1819 Floor space folded	27" x 38"	
1820 Floor space folded	31" x 42"	

2,200 and 4,400 lb. Capacity Heavy-Duty Floor Cranes

- To conserve valuable floor space, crane folds into a compact package for storage.
- For "close-in" work, leg spread adjusts to clear vehicle's wheels, telescoping boom extension gives additional reach. Roller bearing mounted wheels and steering dolly provide ease of mobility.
- A two-speed hydraulic hand pump provides fast boom travel; descent of boom is under precise control of operator.
- Covered by OTC Lifetime Warranty®.

1819 2,200 lb. Capacity Crane. Has hydraulic hand pump and 16-7/8" lifting chain.

39610 1/4" steel chain grade 43, 18-3/8" long, 2,200 lb. capacity. Has safety hook on end. Use with 1819.

1820 4,400 lb. Capacity Crane. Has hydraulic hand pump and 18-3/8" lifting chain.

39611 5/16" steel chain grade 70, 19-3/4" long, 4,400 lb. capacity. Has safety hook on end. Use with 1820.



1813

Boom Capacity (lbs.) Description	Extended 4,000	Centered 5,000	Retracted 6,000
A Maximum boom height	161-7/8"	150-11/16"	139-1/2"
B Minimum boom height	6"	17-3/8"	28-3/4"
C Overall height (boom horizontal)	87"	87"	87"
D Overall length*	129-1/8"	113-7/8"	98-1/4"
E Inside leg length	91-11/16"	76-1/8"	43-1/4"
F Effective boom horizontal reach	94-1/4"	78-3/4"	63-1/4"
G Outside leg width**	59-3/4"	57-3/4"	55-3/4"
H Boom swing	36"	31"	26"
J Inside leg width	35-3/4"		
K Leg height	9-1/16"		
M Wheel diameter	8"		
Dolly wheel diameter	5"		

* Legs in storage position: 80-7/8"

** Legs in storage position: 53-1/2"

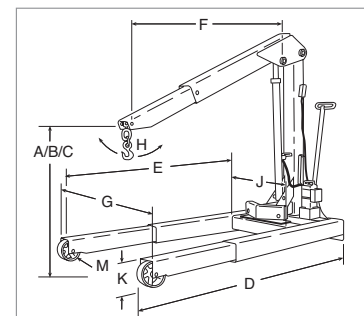

6,000 lb. Capacity Heavy-Duty Mobile Floor Cranes

- Three boom positions give capacities of 4,000, 5,000, and 6,000 lbs. to handle the biggest engines, and often the transmission right along with the engine! Usable reach is almost 92".
- Boom swivels for vertical and lateral positioning; legs extend to straddle the biggest tires.

1814 6,000 lb. capacity crane with electric/ hydraulic pump (115V) with remote motor control.

1813 6,000 lb. capacity crane with two-speed hydraulic hand pump.

FLOOR CRANES / ACCESSORIES HEAVY DUTY TOOLS & EQUIPMENT



2,000 and 4,000 lb. Capacity Folding Floor Cranes

- Both of these cranes fold up for compact storage.
- Front wheels are 5-7/8"; rear casters 3-1/2".

2002 2000 lb. capacity crane with a reach of 24" to 36"

2004 4000 lb. capacity crane with a reach of 26" to 48"

Specifications	2002	2004
Maximum capacity, boom extended	500 lbs.	1,000 lbs.
Maximum capacity, boom retracted	2,000 lbs.	4,000 lbs.
Maximum hook height, boom extended	94"	86-1/2"
Maximum hook height, boom retracted	87"	72-3/4"
Effective boom reach, boom extended	36"	48"
Effective boom reach, boom retracted	24"	26"
Leg width @ front wheels	25"	32-1/2"
Leg height	6-1/2"	7-3/4"
Floor space folded	16" x 17-1/2"	33" x 33-1/2"
Floor space unfolded	57" x 25"	70" x 33-1/2"



4305 1,500 lb. Capacity Engine Load Leveler

Designed to hook to a crane or hoist to handle and position large, bulky components.

- The horizontal tilt can be adjusted to compensate for off-center loads, or adjusted to a certain angle for a component being positioned.

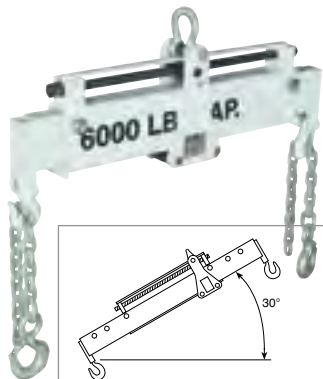

1812

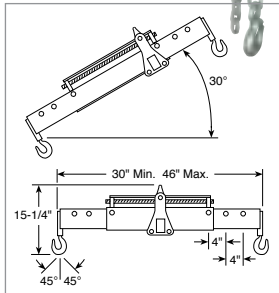

Load Leveler

- Improved design over conventional spreader bars.
- Carriage on main support beam moved by turning lead screw; this permits fine adjustment of the tilt angle of component being lifted.
- Turn lead screw manually or with air-powered tools.
- Spreader bar adjustment secured with locking bolts.
- Chain grade is 80.
- Covered by OTC Lifetime Warranty®.

1812 Load Leveler. Max. lifting capacity: 6,000 lbs.; distance between hooks: min. 30", max. 46".

1822 Load Leveler. Max. lifting capacity: 10,000 lbs.; distance between hooks: min. 36", max. 56".



1806

4,000 lb. capacity Load-Rotor® Positioning Sling

- Use with a floor crane. Engine, transmission, or other component is tilted or leveled by turning sling's 5/8" hex drive end with a common speed handle and socket.
- Has 65-3/4" long chain (5/16") and hook assembly with forged hook on each end. Pair of special lifting brackets included.
- Makes engine removal and installation a snap, even in close quarters.
- For use with floor cranes only; not to be used with overhead hoists or lifts.



Heavy-Duty Adjustable Slings

- For lifting and positioning engines, transmissions, etc. Each chain can be adjusted independently for length; plate design enables chain to be "short-hooked" for correct tilt.

205049 2,000 lb. capacity sling with 1/4" chain, 56" long

205050 4,000 lb. capacity sling with 5/16" chain, 65" long

38841 Plate only, use with any 1/4" or 5/16" alloy steel chain

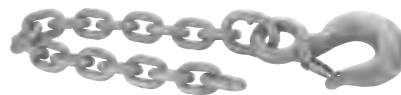

302249

Alloy Chains for Overhead Lifts and Hoists

302941 5/16" alloy chain, 26-13/16" long, 4,000 lb. capacity. With safety hook on one end. Use on No. 1812.

302249 3/8" alloy chain, 28-3/8" long, 6,000 lb. capacity. With safety hook on one end.



7100

4,000 lb. Capacity Lifting Brackets (pair)

- Attach directly to component for easy lifting; will take 1/2" diameter bolts.



Universal Outside Thread Chaser
Damaged bolt or nut threads can be an annoying, costly problem—unless you have one of our thread chasers. It will quickly restore threads to near original condition without the use of expensive thread-cutting equipment.

- Replaceable V-pads and dies.
- 1-1/4" to 5" O.D.

- 7402 Thread chaser with 6 dies:** threads per inch - 4, 5, 6, 7, 7-1/2, 8, 9, 10, 11, 11-1/2, 12, 14, 16, 18, 20, and 24.
- 216884 Standard die set.** Includes 6 dies, in the sizes listed above.
- 202817 Metric die set.** Includes three dies: 1 mm- 1.25 mm-1.5 mm-1.75 mm, 2 mm-2.5 mm-3.0 mm-3.5 mm; 4 mm pitch dies.
- 206803 V-pad.**



6492 Engine Preluber Kit

- Ensures oil is present to internal engine components on the first start of a new or rebuilt engine, or after major engine work is performed.
- Required to prime the oil pump and fill the oil galleries and internal engine components with clean, new oil.
- Connects to engine oil system at the oil pressure sensor on a variety of domestic and import engines.
- Oil pressure sensor adapters included.



4085 1-ton Capacity Hydraulic Spreader
This hydraulic spreader is rated at a full 1-ton capacity at 10,000 PSI and that's enough for a wide variety of jobs. Working in tight spots is no problem—it needs only a 9/16" clearance to engage the jaws. With a big 4" spread, it's ready for a variety of applications: straightening work, removing dents and creases from sheet metal, or as a clamp. The device's spring-return jaws are made of high-strength alloy steel. It can be dead-ended at 4" spread under full load. Ideally suited to work with No. 4012 hand pump (not included).

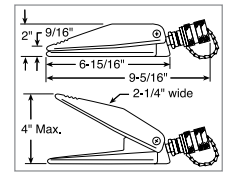

8203L 3-piece Long Handled Pry Bar Set
A set of 3 made-in-the-USA pry bars with comfortable, sturdy rubberized grips. Each bar is drop-forged in Minnesota with a hand-ground chisel end for wedging into tight spaces. Special tempered steel provides extra strength, durability and leverage for tough jobs. A dedicated striking cap provides a big target to drive the pry bar in to help separate components faster. Includes lifetime warranty.

8224 24" handled pry bar
8236 36" handled pry bar
8248 48" handled pry bar



4180 Power Twin Ram and Pump Set

- Center-hole feature permits extending adjusting screws, cables, puller screws, etc., straight through the ram.
- This spring return unit is compact and lightweight.
- Ideal for jobs having restricted working space.
- Set includes 4120 17-1/2 ton, 2" stroke single-acting hydraulic ram; 4002 pump; 9650 gauge; 24815 tee; 9767 hose; and 9798 hose half coupler.



4020 Air/Hydraulic Pump

- Ideal all-around power source develops 10,000 PSI at 100 PSI air.
- Two-stage release mechanism; internal relief valve.
- 98 cu. inches of usable oil.
- Covered by OTC Lifetime Warranty®.



8203S 3-Piece Short Handled Pry Bar Set
A 3-piece Handled Pry Bar Set that includes 8", 12" and 18" lengths for moving or separating components with maximum leverage. Each bar is made from tempered square steel for durability and strength. The dual durometer handle provides a comfortable and secure grip, reducing hand fatigue. A black chrome striking cap will take hammer blows without handle damage, and a polished tip and black oxide finish resists rust and wear during use. Covered by OTC's Lifetime Warranty.

8208 8" handled pry bar
8212 12" handled pry bar
8218 18" handled pry bar

Pumps and Rams

9110B 10-Ton Ram with 6" stroke. Use with the snap-together components of OTC Stinger's collision repair sets, or with most similar competitive products.

9107B Single Speed Hydraulic Pump. Ideal for single acting rams. Developing up to 10,000 psi operating pressure, the pumps operate horizontally or vertically in the "head down" position. Finger tip control provides instant release or pumping action. Has a built-in safety overload valve.



COLLISION REPAIR SETS HEAVY DUTY TOOLS & EQUIPMENT



1513B – 4-Ton



1515B – 10-Ton



Collision Repair Sets, Stinger Series 4- and 10-Ton

- Very competitively priced, yet high quality sets include single-speed hydraulic hand pump, hose, and ram.
- Components snap together for quick setups to apply pushing, spreading.
- Components include: hydraulic pump, hose, and ram; ram flat base; extension tubes (4); 1/2-ton spreader; tube coupling; ram toe; wedge head; serrated saddle; flex head; plunger toe; 90° wedge head; storage case. The case for the 10-ton set has wheels for mobility.

1513B 4-ton collision repair set. Has single speed hydraulic hand pump and ram with 4" stroke.

1515B 10-ton collision repair set. Has single speed hydraulic hand pump and ram with 6" stroke.



1517B – 4-Ton



1519B – 10-Ton



Collision Repair Sets, OTC Series 4- and 10-Ton

- We've matched our OTC hydraulics with versatile tooling.
- Components snap together, permitting you to apply pushing, spreading.
- Components include: hydraulic pump, hose, and ram; ram flat base; 1/2-ton hydraulic spreader; extension tubes (4); tube coupling; ram toe; wedge head; serrated saddle; flex head; plunger toe; 90° wedge head; storage case. The case for the 10-ton set has wheels for mobility.

1517B 4-ton collision repair set. Has single speed hydraulic hand pump (4000A) and ram (4082B) with 5" stroke.

1519B 10-ton collision repair set. Has two-speed hydraulic hand pump (4012A) and ram (4083C) with 6-1/8" stroke.

222618 6 ft. hose 1/4" NPT.

5086 Collision Repair Set, 10-Ton

- Exert hydraulic force just where it's needed to lift, spread, bend, or straighten. Handles the high-force jobs you face daily in trailer maintenance or other applications.
- Includes reliable components including 10-ton, 10-1/8" stroke hydraulic ram; air/hydraulic pumping unit; hydraulic hose; four snap-together extension tubes; extension tube coupling; serrated saddle; flat base; 90° wedge head; flex head; storage case.
- All set components are covered by OTC Lifetime Marathon Warranty®.





4342
DEF Electric Pump Tote Kit with Dispenser Coupler

The Electric DEF Pump Tote Kit quickly transfers fluid from DEF totes. The kit includes everything needed to pump DEF into barrels for easier transport and refilling of vehicle systems. It includes the OTC 4338 Electric Pump, a manual nozzle, hoses and brackets to mount to a standard DEF tote. Additionally, it includes the OTC 4333 Dispenser Coupler to keep moisture out of the container, maintaining high levels of DEF concentration and fluid effectiveness. (Drum and tote not included.)

4341
DEF Electric Pump Tote Kit

Same as the 4342 does not included 4333 Dispenser Coupler.



4344
DEF Electric Pump Drum Kit with Dispenser Coupler

The Electric DEF Pump Drum Kit quickly transfers fluid from DEF totes to barrels. The kit includes everything needed to pump DEF into barrels for easier transport and refilling of vehicle systems. It includes the OTC 4338 Electric Pump, a manual nozzle, hoses and brackets to mount to a standard DEF tote. Additionally, it includes the OTC 4333 Dispenser Coupler to keep moisture out of the container, maintaining high levels of DEF concentration and fluid effectiveness. (Drum and tote not included.)

4343
DEF Electric Pump Drum Kit

Same as the 4344 does not included 4333 Dispenser Coupler.



4333
DEF Dispenser Coupler

The reusable DEF Dispenser Coupler helps maintain diesel exhaust fluid concentration and purity by preventing contamination. It connects and disconnects easily from compatible containers including 55-gallon drums and DEF totes. Viton seals nearly eliminate leaks and stainless steel construction provides extra durability and reliability.



4334
Digital Turbine DEF Flow Meter

OTC's DEF Digital Turbine Flow Meter accurately measures fluid volume transferred for DEF, windshield washer fluid and other water-based fluids, even in severe weather conditions. It is designed for measurement in-line or end-of line when used with a dispensing nozzle. The digital display shows fluid transferred in quarts, pints and gallons and uses two AAA 1.5 volt batteries. Polyamide construction ensures a strong and protective housing for durability and a long work-life.



4339
Air Operated DEF Pump

OTC's Air Operated DEF Transfer Pump uses compressed air to pump and quickly move DEF and other fluids. It is designed to be mounted to drums from 15 to 55 gallons using its built-in 2" bung adapter. A versatile and industrial design enables the pump to also move engine oil and antifreeze without damage.



4337
Rechargeable Electric Pump

This Rechargeable DEF Transfer Pump makes dispensing diesel exhaust fluid easy in remote locations. A flow rate of 6 gallons per minute with a charge that lasts 15 minutes can transfer up to 90 gallons on a single charge. It is lightweight and easy to use with drums or totes with a telescoping inlet tube and flexible hose. Included with the pump is a one-hour quick charger, a lithium-ion battery and a manual nozzle.



4338
Electric DEF Transfer Pump

The 115 volt 3.0 amp electric DEF pump can pump at a rate of 9 gallons per minute for 30 minutes for more heavy usage. Generating .5 horsepower with speeds up to 2850 rpm, the pump can quickly move up to 270 gallons in 30 minutes. Lightweight construction makes it easy to transport while still being capable of withstanding rain and is engineered to pump water and antifreeze in addition to DEF.



4336
Hand Operated DEF Pump

The lever-action barrel-style hand pump pulls DEF from 15 to 55-gallon drums with a 2" opening without any electricity or compressed air. The hand-operated pump is ideal for low-volume DEF transfer in the field or the shop. A lightweight and durable design features a long telescoping inlet tube and flexible outlet hose. The multi-purpose design can also be used with engine oil, antifreeze, and windshield washer fluid.



4340
Air Operated Double Diaphragm DEF Pump

The Air Operated Double Diaphragm DEF Pump makes quick work of large-volume DEF transfer. It easily installs on most containers or free-floating in fluid. A versatile design can transfer contaminated liquids when cleaning out pits and, when properly installed, is capable of submersed operation. It can also pump antifreeze, ethanol and waste water.



4335
Auto Shut-Off DEF Nozzle

A dual-mode automatic DEF control nozzle that can be held open manually or locked to control flow of fluids. It will automatically shut off once the DEF level in the tank reaches the outlet discharge spout to avoid spilling or overfilling. It has a heavy duty stainless steel cast body with a polyamide cover for durability and protection. It can also be used with other water-based fluids and E85.

5286

Portable Diesel Particulate Filter Cleaner

The Diesel Particulate Filter (DPF) Cleaner was designed with shop service in mind. Its portability allows the unit to be placed as close to the vehicle as possible and to be stored wherever needed in the service facility. The advent of the 2010 Tier 4 cleaning requirements created the need for a lighter, more portable cleaning system which can be taken into the field to clean filters at the point of service.

Diesel Particulate Filter features

- Lightweight and Highly Portable - ideal cleaning system for use in the shop or on a service truck.
- Flexibility - clean DPF's from 6" to 15.5" in diameter using shop or compressed air of at least 100 PSI and 20 CFM sustained airflow.
- Fully Automated Operation - once started, the cleaning process can be completed with minimal operator oversight, freeing up the technician to simultaneously do other work in the shop.
- Focused Air Jet Technology™ - concentrates a precise high pressure stream of air directly into every cell.
- Easy Maintenance - contains no internal filters that require user maintenance.
- Rugged design provides maximum durability.
- Operates on 12-24 volt DC, or 110-220 Volt AC.

Efficiency by the Numbers*

- Cleans up to 20% more efficiently than traditional pulse based systems.
- Cleans up to 5% more efficiently than other more expensive "air knife" systems.

*Based on third party OE test data using Pin-gauge measurement.

Unique floating puck prevents "splash back"

- Features Focused Air Jet Technology™ with a unique floating puck that prevents splash back.
- Includes three nozzles: two straight (short and long), for standard "open face" DPFs; and one curved for the angled-flange DPFs.
- Ensures quiet operation.

Ash disposal System and Shield

- Innovative ash disposal system enables technician to quickly and easily remove and dispose of particulate matter in accordance with local environmental requirements.



5286 kit includes:

- Cleaning unit
- Three neoprene rings fit filters from 6 in. (165 mm) to 15.5 in. (400 mm) in diameter
- Wet / dry HEPA vacuum
- Short, long, and curved-flange filter nozzles
- Adjustment feet for standard and flanged filters
- Ash disposal kits
- AC and DC adapter cables

Accessories

563197

(Set of 5) – Ash disposal system enables technician to quickly and easily remove and dispose of particulate matter in accordance with local environmental requirements.



Curved neck nozzle with floating puck for angled-flange DPFs.



Long nozzle with floating puck for standard open face DPFs.



Includes innovative shield to protect cleaning area from moisture.





5280
OTC 5280 Diesel Particulate Filter Cleaner

The Diesel Particulate Filter (DPF) Cleaner was designed with shop service in mind. The cleaning process allows the DPF to be cleaned as part of a general maintenance schedule at the service location with minimal time away from the vehicle. It's portability allows the unit to be placed as close to the vehicle as possible and to be stored wherever needed in the service facility.

DPF Cleaner Features

- OE tested and Dealer recommended – By many major diesel engine manufacturers. Robust design – For long shop life. Can be used as part of a preventative maintenance program.
- High Pressure cleaning process for thorough cleaning of ash from DPF – produces 10 times the burst energy of competitive low pressure units.
- Initial Burst Quick check – To identify filters too plugged for proper cleaning.
- Movable with locking wheels – For placement throughout the shop.
- Computer Controlled Process Based on OE Requirements – for "Start to End" cleaning without constant technician monitoring.
- Containment of hazardous ash – For easy disposal.
- HEPA Filter Air Exhaust System – To exceed environmental air standards for shop.
- Operates on standard 115V outlet.
- Proven to clean to over 92% efficiency. (3)

(3) Third-party OEM test results using pin gauge measurement with approved OTC adapters and burst cycles. Actual results may vary.

Replacement Filters:

	558569	12" HEPA Filter
	558570	Vacumm Replacement Filter
	558571	30" Air Filter Cartridge
	558572	Replacement Desiccant
	558573	Replacement Element Filter

Includes the following items:

	535936	Small Cone
	543887	Medium Cone
	543885	Large Cone
	553913	CAT Adapters
	553915	Cummins Adapters

Seal Repair Kits

557281	Cone seal repair kit
557282	CAT adapter seal repair kit
557283	CUMMINS adapter seal repair kit
557510	VOLVO adapter seal repair kit
557511	ISUZU adapter seal repair kit
557553	UD TRUCK/HIND seal repair kit
557554	DETROIT DIESEL adapter seal repair kit

Upgrade kits for other OEM's are sold separately:

	556889	Detroit Diesel Upgrade Kit
	553990	UD TRUCK (with Hino Engine) Upgrade Kit
	553991	Isuzu Upgrade Kit
	553993	Volvo/Mack Upgrade Kit
	558181	Navistar Upgrade Kit Requires use of 5281 DPF Thermal Processing Unit.
	554654	Includes all upgrade kits shown above

DPF EQUIPMENT HEAVY DUTY TOOLS & EQUIPMENT

5281

OTC DPF Thermal Processing Unit

The 5281 DPF Thermal Processing Unit is a device which will thermally regenerate a DPF unit at a controlled, pre-programmed rate. Sometimes, the DPF cannot be regenerated on the truck due to a failure with the vehicle's own regeneration system, or in the case of retrofit applications, a lack of an on-vehicle regeneration system. Thermal regeneration of DPFs is used in conjunction with the OTC 5286 DPF Cleaner.

Designed to facilitate the cleaning of dirty filters – especially those with high amounts of wet soot, and unburned hydrocarbons.

- Pre-programmed thermal profile controls temperature 'ramp up' and 'cool down' to protect the DPF from thermal shock, reducing the risk of cracking the DPF.
- Holds temperature constant for two hours to ensure complete regeneration of filter.
- Includes both standard cycle and "pre-treat" cycle for oil-soaked filters.
- Built-in electronic safety lock prevents unauthorized opening of the door when temperatures exceed 200 degrees F.
- Large chamber accommodates various DPF sizes and shapes. Front access door allows for easy access to the thermal chamber.
- 220VAC / 60Hz / Single phase / 50 Amp.
- 1-year warranty.
- CE, UL201, UL499.
- Internal chamber dimension: 24" (L) x 24" (W) x 26" (H).

CE



Electronic safety lock.



J-47399

Horizontal DPF Handler

- The Universal mounting assembly adjusts front to back and side to side for easy DPF handling
- The height range of 6-1/2" to 29-1/2" is ideal for most of today's trucks
- Safety strap holds the load securely while moving about the shop

Specifications:

Overall Length: 34-1/2"

Overall Width: 19-3/8"

Max. Height: 29-3/4"

Min. Height: 7-1/2"

Side tilt: 30°, Front tilt: 15°, Back tilt: 15°



5025 OTC DEF Refractometer

Kit includes: Refractometer, dropper, lens wipe cloth, instructions and quick guide, screwdriver and case.

5025

DEF Refractometer

SCR and EPA 2010

EPA regulations require all diesel engines manufactured on or after January 1, 2010 to meet lowered NOx emissions standards.

- Most heavy duty engine (Class 7-8 trucks) manufacturers, have chosen to utilize SCR. This includes Detroit Diesel (DD13, DD15, and DD16 models), Cummins (ISX line), PACCAR, and Volvo/Mack.
- SCR-equipped engines require the periodic addition of Diesel Exhaust Fluid (DEF, a urea solution) to enable the process. DEF is available in a bottle from most truck stops, and some have installed bulk DEF dispensers near the Diesel Fuel pumps. However, to ensure the proper operation of the SCR system, operators must ensure the DEF in their vehicle consists of a 32.5% Urea / Water solution.
- The OTC 5025 makes this a simple and quick process for an operator or technician.

Application:

The refractometer is a portable, precision, optical instrument used for measuring the Diesel Exhaust Fluid (DEF) concentration. When a liquid sample is placed on the prism, the light passing through it is bent. The more concentrated the liquid, the more the light will bend. The refractometer contains a reticle, or scale, that is enlarged through the eyepiece to measure this light. The values on the scale have been established to evaluate the DEF condition.

Scale:

0.5% line graduations

32.5% Indicated

Scale 15-40%

Waterline & 20 Deg C

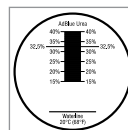

The scale without any liquid on the prism.

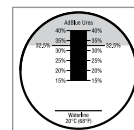

The scale with liquid on the prism. The reading is taken at the point the shadow line crosses the scale.



SHOP EQUIPMENT

Clutch Lifts	200
Power Train Lifts	200
Air Lifts / Driveline Lifts	201-202
Transmissions Jacks	201-202
Truck Ramps	203
Under Axle / Service Jacks	204-207
Fork lifts	208
Stands	208
Car Dollies	209
Brake Drum Dolly	210
Wheel dollies	210
Engine Stands	211-212
Engine support Bars	212
Floor Cranes	213-214
Lifting Chains	214
Filter / Fluid / Oil Service	215
Presses & Accessories	216-219
Bottle Jacks	220
Collision Repair Sets	221
Hydraulic Spreaders	221
Hydraulic Flow Meters	222-223
Hydraulic Pumps & Rams	224-232
Hydraulic Accessories	233-234

CLUTCH / POWER TRAIN/AIR LIFTS SHOP EQUIPMENT



- 5018A**
Truck Clutch & Flywheel Handler
 • Replaces 14" & 15-1/2" clutch assemblies weighing up to 250 lbs.
 • 13" low point enables access below side faring.
 • Linkage raises load from horizontal to vertical position.
 • 360 degree swivel head.
 • Includes a 2" spline shaft with a 1-1/4" pilot to aid alignment.
 • Covered by OTC Lifetime Warranty®.

- 516160** Optional flywheel handling attachment
515686 Optional splined shaft, 1-3/4" dia. with 1-1/4" pilot
516159 Optional splined shaft, 1-3/4" dia. with 1" pilot



- 5015A**
Truck Clutch & Flywheel Handler
 • Handles 14" and 15-1/2" clutch assemblies weighing up to 150 lbs.
 • Lifting range of 9" to 37". Swivel casters provide easy maneuverability.
 • Includes a 2" spline shaft with a 1-1/4" pilot to aid in alignment.

- 218174** Flywheel handling attachment for use on No. 5015 and 5015A only.
48625 Optional splined shaft, 1-3/4" dia. with a 1-1/4" pilot.
440533 Optional splined shaft, 1-3/4" dia. with a 1" pilot. Needed for clutch service on some Navistar 466 series engines.
314386 Optional 1-3/4" dia. alignment shaft extension. Used for 2-plate clutch of Navistar 466 series engine.



1520
10-Ton Capacity Lifting System (Includes two lifts)

- Mobile, tandem system is air-operated. This will handle your class 7 and 8 tractor lifting needs. No need to waste time re-blocking and making additional lifts for the clearance you need for under-vehicle service. Roll the system to the vehicle anywhere in the shop or outside on a level surface.
- Unique design provides lift from the tires, not the frame or axle members. Ideal for situations where limited ground clearance or a lack of clear access complicates lifting.
- Single controller operates both sides of the system for a smooth, level lift up to two full feet from the bottom of the tires to the ground. Units can double as support stands when retention pin is inserted.
- Covered by OTC Lifetime Warranty®.

Specifications:
 Capacity – 10-tons (20,000 lbs.) (pair)
 Air pressure – 150 psi
 Lifting range – 0"-24"
 Saddle width – 19-1/2" –

24" dia. rim sizes	Height – 53-1/4"
Width – 41-1/2"	Length – 39-1/2"

Power Train Lifts

- These lifts will handle engine and transmission assemblies, gas tanks, drive axle assemblies, engine/transaxle assemblies, electric vehicle batteries, and more.
- Scissors-type design allows access to all four sides of a component.
- Two independent adjusting screws tilt the table ±15° side-to-side, or fore and aft. Can be operated manually or with non-impact air wrench.
- 20" x 32" table.
- 8" swivel casters provide enhanced mobility under heavy loads.
- ANSI/PALD compliant.

5285 Power train lift (1,650 lb. Capacity)

Air / hydraulic operation – Foot control pump with hose allows movement around lift.
 • Min. height is 31-1/2"; Max. height is 74-1/2".
 • Footprint 33" wide x 48" long.

1595 Power train lift (2,500 lb. Capacity)

Powered by a quiet, 110V electric/hydraulic pump.
 • Smooth, steady lifting and lowering motion controlled by hand-held remote.
 • A 30 ft. long retractable extension cord is mounted to the frame.
 • Min. height is 29"; Max. height is 80"
 • Footprint 31" wide x 50" long.

5295 Powertrain Lift (1,760-lb capacity)

The sliding split table top design of this powertrain lift allows for separation of the engine/transmission assembly or hybrid engine/generator module, making service easier. The unique design also helps handle removal and installation of electric vehicle batteries, fuel tanks, suspension systems and other powertrain assemblies. A generous ground clearance allows for floor crane access while a low collapsed height aids in servicing large components while still on the lift. The table tilts to help properly align components to the vehicle during installation and threaded holes in the tabletop accommodate future adapters and powertrains.
 • Similar to GM lift P/N GE-52200 and Honda lift P/N HON52200.

1590
10-Ton Air Lift

- Adjustable lifting saddles and an extra-wide stance for extra stability.
- Automatic mechanical safety catch engages in five height positions.
- Two large swivel casters and pneumatic tires make it easy to maneuver, even on loose gravel.
- Covered by OTC Lifetime Warranty®.

Specifications:

Capacity – 10 tons (at 200 psi air)	Saddle – 4" X 5-1/4"
Air pressure – 100–200 psi	Height – 67-1/2"
Lifting range – 13"–52"	Width – 41"
Saddle spread – 29" – 41-3/4"	Length – 36"
	Distance from lift arm to floor support – 12-1/2"

572913

Optional saddle set for 1590. Saddle – 4" X 5-5/8"



5267

Lift Pad Adapters, set of two

The adapters sit on the hoist or jack saddle and seat inside frame holes on GM vehicles to prevent saddle lip from damaging frames or subframes. Similar to J-43625.



5285 extended

Casters provide a 9-1/2" clearance on lower frame



5285 collapsed



5295 extended



1585A
Power Train Lift – 1,250 lb. Capacity

- For easy removal and installation of engine/transaxle assemblies on FWD vehicles. Also handy for pulling rear ends, leaf springs, and more.
- Includes 4020 air/hydraulic pump.
- Your shop air supply is the only thing you need to get the precise control.
- Width between wooden support blocks is adjustable from 0–29". Load is secured with a tough nylon strap.
- Covered by OTC Lifetime Warranty®.

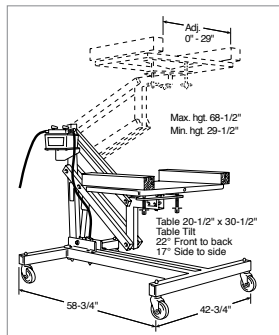

5078
Transmission Jack Air-Assisted
2,000 lb. Capacity High-Lift, for Trucks & Buses

- Foot-operated air pump enables the operator to effortlessly raise the transmission into place.
- Rugged, heavy wall tubing and oversized base for stability.
- A dedicated adapter for Allison 500- and 600-series automatic transmissions is included.
- Covered by OTC Lifetime Warranty®.

Specifications:
Min. height is 41-1/2" Backward tilt – 38°
Max. height is 65" Side tilt (side/side) – 14°
Forward tilt – 50° Leg width – 46"



Head adjustable to 19-1/2" x 18".

1728
Air-Assisted 1,000 lb. Capacity High-Lift Transmission Jack

- Unique foot pedal design gives you complete control over the air-driven first stage to rapidly raise the mounting head to the transmission; second stage is hydraulically actuated — permitting precise operator control during removal and installation.
- Transmission mounting head features four ratcheting brackets that adjust to fit a wide range of transmissions. Four-wheel base with locking swivel casters provides stability and portability.
- Safety bypass prevents damage caused by a system overload.
- Carries OTC Lifetime Warranty®.

Specifications:
Min. height is 34-1/2" Max. height is 72"
Max. forward tilt – 40° Max. backward tilt – 20°
Max. side tilt (either side) – 10°
Leg width – 41" Air pressure (psi) 90 to 160



1793A
1,000 lb. Capacity High-Lift Transmission Jack

- Universal saddle tilts front to back and side to side; features adjustable corner brackets and safety chain for optimum positioning of the load.
- Flash-chromed rams inhibit rust from entering the hydraulic system.
- Foot-operated pump and lowering pedal for ease of control when positioning or removing a transmission.
- Wide leg base with 4" polyurethane swivel wheels that provide stability and easy maneuvering. (Brakes on two of the wheels.)
- Safety overload system to prevent jack from being used beyond its rated capacity.

Specifications:
Min. height is 35" Max. height is 71-5/8"
Max. forward tilt – 24° Max. backward tilt – 19°
Max. side tilt (either side) ± 20°
Leg width – 37-1/8"



Folding foot pedal.

5237
1,000 lb. Capacity High-Lift Transmission Jack

- Universal mounting head provides wide fore and aft tilt range.
- Two-stage hydraulic cylinder design.
- Innovative folding foot pedal and release provides precise ease of control when positioning or removing a transmission. - Significantly reduces force required to lift extremely heavy transmissions.
- Upgraded ergonomic handles for adjustment.
- ANSI/PALD compliant.

Specifications:
Min. height is 34-1/2" Max. height is 75"
Max. forward tilt – 50° Max. backward tilt – 20°
Max. side tilt (either side) – 10°
Leg width – 41"



1794A
Air-Assisted 1,000 lb. Capacity High-Lift Transmission Jack

- Air-assist primary stage for rapidly raising the mounting head, activated by depressing foot pedal.
- Hydraulic secondary stage for precise operator control, activated by a hand pump to raise the load, and a release knob to lower the load.
- Big, easy-to-grip knobs that make mounting head adjustments simple, and a safety chain for securing the load.
- Wide leg base with 4" polyurethane swivel wheels that provide stability and easy maneuvering. (Brakes on two of the wheels.)
- Safety overload system to prevent jack from being used beyond its rated capacity.

Specifications:
Min. height is 37-5/8" Max. height is 76-1/2"
Max. forward tilt – 42° Max. backward tilt – 46°
Max. side tilt (either side) ± 12°
Leg width – 37-1/8"

TRANSMISSION / DRIVELINE LIFTS SHOP EQUIPMENT



- 5130**
1,000 lb. Capacity DriveMaster™ Driveline Lift
- Low profile of 7" and a Lift range: 7" to 30".
 - Pivoting pump handle +/- 15° tilt in each direction
 - Includes 553516 Differential Adapter
 - ANSI/PALD
- Specifications:
Overall Length – 43"
Overall Width – 30-1/4"
Max. Height – 30"
Min. Height – 7"



- 1521A**
1,000 lb. Capacity Low-Lift Transmission Jack
- Universal mounting head, with adjustable brackets, tilts front to back and side to side for easy transmission alignment.
 - Safety chains hold the load securely, even while moving about the shop.
 - Wide, stable wheel base with four swivel casters, and two handle grips make it easy to position under the vehicle.
 - Safety overload prevents jack from being used beyond its rated capacity.
 - Pump handle rotates a full 360° for use in any position.

- Specifications:
Min. height is 7-1/2" Overall length – 34-1/2"
Max. height is 29-3/4" Overall width – 19.3/8"
Max. forward tilt – 67°
Max. backward tilt – 17°
Max. side tilt (either side) – 30°

1591B
**Air Lift & Support Stand
10-Ton Combination**

- 40" removable handle and 8' air hose.
- Covered by OTC Lifetime Warranty®.

- Specifications:
Capacity – 10 tons (at 200 PSI air)
Minimum height (unpinned, no extension) – 18-3/4"
Maximum height (pinned in top hole, with extension) – 50-1/2"
Stroke – 10-7/8"



- 5019A**
2,200 lb. Capacity Low-Lift Transmission Jack
- Special mounting adapter fits popular Eaton® Fuller® RoadRanger® transmissions used on nearly all Class 7 and 8 heavy-duty trucks. Mounting plate angle is adjusted with the turn of a wrench.
 - Swiveling pump handle permits ease of operation in restricted working spaces.
 - Fast-acting pump quickly raises lifting arm.
 - Includes No. 504231 adapter for Eaton® Fuller® RoadRanger® transmissions (also available separately).
- Specifications:
Min. height is 8-1/4" Side tilt (either side) – 12°
Max. height is 36-1/2" Overall length – 52"
Forward tilt – 15° Overall width – 32-1/2"
Backward tilt – 20°



- 1522A**
Heavy-Duty 2,000 lb. Capacity Low-Lift Transmission Jack...for Class 7 and 8 Trucks
- Includes No. 220492 adapter for Eaton® Fuller® RoadRanger® transmissions.
 - Pump handle rotates 360° for operator convenience; ball bearing 3.5" diameter swivel casters provide easy positioning of jack.
 - Safety overload system prevents use of jack beyond its rated capacity, and a safety bypass protects the hydraulic cylinder from damage.
- Specifications:
Min. height is 6-7/8" Side tilt (either side) – 11°
Max. height is 35-1/4" Overall length – 43-1/2"
Forward tilt – 24° Overall width – 26"
Backward tilt – 18°

5091
Heavy-Duty Spindle Adapter

This low-lift transmission jack adapter holds the spindle assembly firmly in place during king pin service. It eliminates the need to completely disassemble the brakes to reduce spindle weight for handling. During service, the spindle assembly can be raised to a comfortable working height while replacing king pin bearings or bushings. Our patented design will work with standard HD truck bolt patterns and wheel stud sizes and adapts to most low-lift transmission jacks.

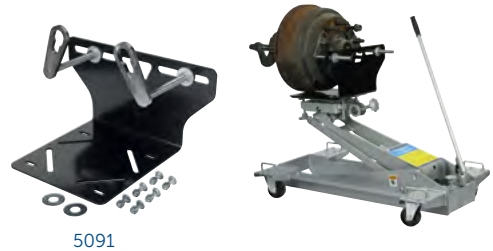

**Transmission Jacks Accessories
for 5019A / 5078 / 1522A and 5130 Driveline Lift**

- 558382** Auxiliary box adapter. Used with all.
- 561949** Light duty transmission adapters. Used with all.
- 528150** Eaton® "Lightning" adapter. Used with the No. 5019A transmission jack.
- 543284** Roadranger transmission Model series FRO-11210C to FRO-18210C that is equipped with an internal cooler. Used with the No. 5019A transmission jack.
- 49611** Eaton® Fuller® RoadRanger® auxiliary housing adapter. Bolts directly to the countershaft bearing caps to provide a stable platform for removing and installing the auxiliary housing.
- 553516** Differential Mounting Adapter. Mounts easily using existing bolt patterns. Fits the most common differentials currently in use on Category 7 and 8 Heavy Duty Trucks. Including: Eaton, Fuller, Rockwell, Meritor, Spicer, International, and Mack. For use on OTC (5019A – 553516 requires 565188 adapter) 5078 and Stinger 1522A Transmission Jacks.
- 314729** Allison 500/600 series automatic trans-mission adapter used with No. 5078 transmission jack.
- 540231** Eaton® Fuller® RoadRanger® transmission adapter
- 540232** Mack transmission mounting brackets. Provides a stable platform for Mack T200 series transmissions.

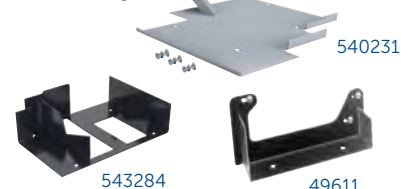



1870

Universal Transmission Adapter

Universal transmission adapter with independently adjustable and indexing locking arms that adapt to nearly any transmission shape. The adjustable mounting arms will fit most high-lift transmission jacks. Maximum capacity of 400 lbs. Meets or exceeds current ASME PASE standards for portable automotive service equipment.



223196

Transmission Jack Mounting Adapter Set

- Used with No. 1728 transmission jack. Ideal for use on larger standard transmissions with irregularly shaped oil pans.
- Four adjustable arms help stabilize transmissions that have rounded bottom surfaces.

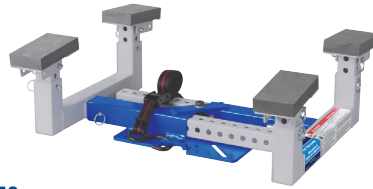

1758

Fuel Tank Handler

- Provides safe and efficient handling of fuel tanks. Adjustable from 24" to 38" horizontally, and 7" to 11" vertically, to service tanks up to 40 gallons.
- Universal adapter plate fits all OTC and virtually all competitive transmission jacks and power train lifts in the market.
- Gearing mechanism ensures equal extension of lift arms to ensure load is properly balanced over jack.
- Four adjustable support risers can be individually adjusted to ensure a perfect fit to any fuel tank design.
- Cross-link polyethylene foam pads protect tank from damage.



Shown mounted on an OTC high-lift jack.

7020 Similar to Ford T57L-500-B, 307-003



7020

Bench-Mounted Holding Fixture

- Here's a helpful device that enables you to securely hold and rotate small engines, transmissions, and other components while you're working on them.
- This holding fixture will handle pieces weighing up to 250 lbs., and it offers 360° of rotation with positive stops at 90° increments.
 - Three sides of the mounted unit remain fully exposed.

34607

Base assembly only.

34607 Similar to Ford D83L-500-B1, 300-D041

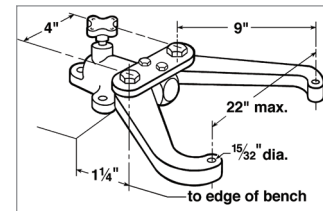

20-Ton Truck Ramps

- Long, retractable T-handle enhances mobility.
- Non-skid rubber matting prevents slippage during use.
- Durable, heavy-duty rubber wheels.
- Capacity per pair is 20 tons
- Covered by OTC Lifetime Marathon Warranty®.

5268 – 20-ton truck ramps handle up to 10" tread width.

5269 – Wide 20-ton truck ramps handle up to 16" tread width



5268



5269

7118

Transmission Adapter Kit

Converts your OTC engine stand into a transmission service stand.

- Kit replaces the adjustable arms of the stand to hold and position the transmission at workbench height for repair.
- The transmission is held with three sides fully exposed for working convenience, and can be rotated a full 360° for complete access to all parts.



Model	Frame Height	Frame Width	Frame Length	Wheel Diameter	Handle Length
5268	9-1/4" (23.5 cm)	13-1/2" (34.29 cm)	47" (119.38 cm)	5" (12.7 cm)	33" (83.82 cm)
5269	9-1/4" (23.5 cm)	18-1/4" (46.36 cm)	47" (119.38 cm)	5" (12.7 cm)	33" (83.82 cm)



Convenient and secure storage space for large adapter & saddle.



Maximum extended height

Saddle

Large adapter

5292 27.5-Ton Under Axle Jack

- Features class-leading 27.5 ton capacity
- Robust design with completely sealed piston.
- New lever design and pneumatic release valve for more precise release control.
- Power return allows lowering with no load.
- Includes two height adapters for flexibility.
- PALD compliant.
- Minimum retracted height (with saddle only): 8-1/4".
- Maximum extended height (with screw extended and large adapter): 21-3/8".
- Stroke: 4.9375".
- PSI range: 90 to 175.

5093B 3-Stage Under-Axle Jack

Three-stage lift capacity 22.1T, 38.5T, and 71.5-tons. Ideal for lifting loaded trailers, buses, and other Class 7 & 8 vehicles.

- Piston and cylinders are made from chromium molybdenum vanadium steel for durability and then liquid nitrided to prevent rust and seizing.
- Features a high load-approach speed.
- Air-driven cylinder with pressure control knob for maximum user safety.
- 4-position handle: horizontal, 45 degrees, vertical, or collapsed.
- 7-inch minimum height for low clearance vehicles.
- Comes complete with a 3-15/16 in. (100 mm) lifting extension.
- Complies with ASME / PALD test requirements.



Single control switch, handy and easy to use.



4 positions: horizontal, 45 degrees, vertical, or collapsed for easier transport.



8-1/4" width for easy access to the lifting point.

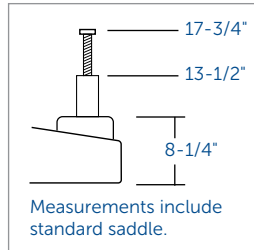

1788B 22-Ton Capacity Under-Axle Jack

- Improvements include advanced seal ring material and one-piece air piston air pump
- Long 49-1/2" T-handle lets you easily position jack under vehicles with long overhangs.
- One pull of the handle activates the self-retracting 22-ton capacity ram without having to crawl underneath the vehicle.
- Jack has large rubber-tired wheels.
- Lifting range:

3/4" saddle	Max. height 17-3/4"
1-15/16" saddle	Max. height 18-15/16"
3-7/8" saddle	Max. height 20-5/8"
- Cylinder stroke, 4-1/2"; extended screw length, 4-1/4"; PSI range, 90-145.

215009

- * In-line oil lubricator. Add to air line to meter precise flow of lubricant to air motor. Has 1/4" NPT fitting.
- * Not included, order separately. Prevents harmful contamination caused by moisture in the air line!



1-7/8" Low Profile

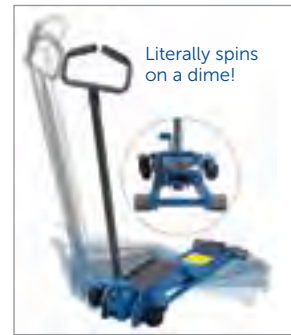

Literally spins on a dime!

5200 Ultra-Low Profile 2-Ton Service Jack

- Minimum saddle height of just 1-7/8".
- Unique, fifth-wheel design provides effortless 360° maneuverability – literally spins on a dime!
- Featuring Polyamide casters – superior to cast wheels due to their high mechanical strength and thermal properties.
- Foot pedal for quick approach of saddle to lifting point. Ergonomic handle for user comfort and enhanced mobility.
- Lifting range of 1-7/8" to 20-1/2".
- CE marked – ASME / PALD tested.

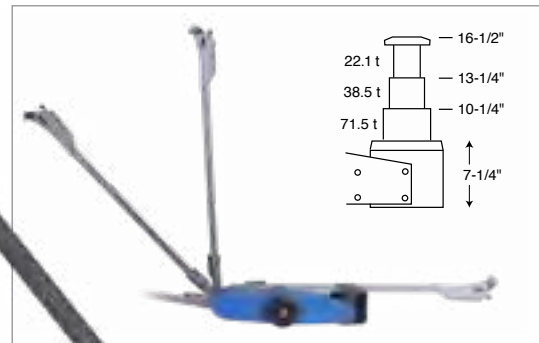



5202

2- & 3-Ton Service Jack

- Ergonomic handle for user comfort and easy mobility.
- Foot pedal for quick approach of the lifting saddle to load. Built-in tray for fasteners and tools.
- CE marked – ASME/PALD tested.
- Covered by OTC Lifetime Warranty®.

5202A

2-ton Service Jack

Min. height 3"; Max. height 18-1/4".

5203A

3-ton Service Jack

Min. height 5-1/2"; Max. height 20-1/2".

Specifications	5202A	5203A
Capacity	2-ton	3-ton
Min. height	3"	5-1/2"
Max. height	18-1/4"	20-1/2"
Overall length	34-5/8"	42-1/4"
Overall width	14-3/16"	14-3/16"
Handle length	39-1/2"	39-1/2"



1533A Includes 1532A and 1582A

1532A 2-Ton Aluminum Service Jack

- Light-weight aircraft-grade aluminum construction makes it easy to carry and roll
- Low profile allows it to be used with ground-hugging high-performance cars
- Meets ASME PASE-2014 Standard for Service Jacks
- Includes side mounted carrying handles for quick and easy carrying
- Min. height 3-1/4"; max height 18-5/8"

Product Specs:

- Handle Length 47.6 inches
- Saddle Diameter 4.5 inches
- Wheel Diameter 2.5 inches
- Caster Diameter 1.75 inches
- Strokes to Full Height 5
- Actuating Handle Effort 85 lbs

1582A 2-Ton Aluminum Jack Stands (2 included)

Flat round base doesn't dig in to soft surfaces such as asphalt

- Placement of hole locations allows for broad range from low to high heights
- Light weight material makes handling and use easy

Product Specs:

- Low Height 9.5 inches
- High Height 15.2 inches
- Number of Adjusting Positions 6
- Base Diameter 7.0 inches
- Weight of Each Stand 4.70 lbs
- Saddle Size 2.2 x 2.2 inches

1547 Includes 1532A and 1582A

1546 3-Ton Aluminum Service Jack

- Light-weight aircraft-grade aluminum construction makes it easy to carry and roll
- Low profile allows it to be used with ground-hugging high-performance cars
- Meets ASME PASE-2014 Standard for Service Jacks
- Includes side mounted carrying handles for quick and easy carrying
- Min. height 3-5/8"; max height 19-3/16"

Product Specs:

- Handle Length 47.6 inches
- Saddle Diameter 4.6 inches
- Wheel Diameter 2.6 inches
- Caster Diameter 2.0 inches
- Strokes to Full Height 7
- Actuating Handle Effort 106 lbs

1596 3-Ton Aluminum Jack Stands (2 included)

Flat round base doesn't dig in to soft surfaces such as asphalt

- Placement of hole locations allows for broad range from low to high heights
- Light weight material makes handling and use easy

Product Specs:

- Low Height 9.5 inches
- High Height 15.6 inches
- Number of Adjusting Positions 6
- Base Diameter 7.1 inches
- Weight of Each Stand 4.74 lbs
- Saddle Size 2.2 x 2.0 inches

552650

Aluminum Racing Jack wall Mount

Ideal for storing or displaying OTC Racing Jack:

- Easily mounts to shop wall or side of truck.
- Includes convenient snap-in handle clasps.
- Velcro strap for additional security.



**SEE PAGE 208 FOR
JACKS STANDS
3-TON, 6-TON AND
12-TON STANDS.**





5302



5303

2-1/4 / 3-Ton Hydraulic Service Jacks

- Flanged upper body edge increases strength to resist twisting.
- Light, compact design makes them easy and convenient to use.
- Built-in safety overload system protection prevents use beyond their rated capacity.
- Rear swivel casters, for easy maneuvering and positioning.
- These jacks have 4" saddle dia., 21" overall reach, 6-1/2" frame height,
- 39-1/2" handle length, and a floor space of 13-1/2" x 24-1/2".

5302

2-1/4-ton capacity with a lifting range of 5" to 18".

5303

3-ton capacity with a lifting range of 5-3/4" to 18-1/2".



**5300
OTC Stinger 3-Ton Jack Pack**

This jack pack includes (5303) 3-ton service jack and (5372) Pair of 3-ton jack stands.

5303 3-Ton Service Jack

- Flanged upper body edge increases strength to resist twisting.
- Light, compact design makes them easy and convenient to use.
- Built-in safety overload system protection prevents use beyond their rated capacity.
- Rear swivel casters, for easy maneuvering and positioning.
- Lifting range of 5-3/4" to 18-1/2"
- 4" saddle dia., 21" overall reach, 6-1/2" frame height.
- 39-1/2" handle length, and a floor space of 13-1/2" x 24-1/2".

5372 3-Ton Service Jack Stands

- Base: 8-1/4" x 7-1/2".
- Height range: 12" to 17-11/16".
- 11 adjustment positions.
- Welded foot pads resists sinking into soft ground or asphalt.



**1536A
OTC Stinger 3-1/2 Ton Jack Pack**

This jack pack includes (1526A) 3-1/2-ton service jack and (1796) Pair of 4-ton jack stands.

1526A Two-Speed 3-1/2 Ton Service Jack

The ideal floor jack for both a large automotive service center or a one person shop.

- Gets to the load quickly.
- One pump to load; three pumps to full height unloaded.
- Extra wide lift range – from 4" to 21".
- A long 48" spring-loaded handle provides rapid return after each pump.
- Heavy-duty construction – rolled edges add strength and resist twisting.
- With a wheel base of 23", the front wheels are 3-1/2" diameter and rear casters are 2-1/8".
- Pinned 4-3/4" saddle will not lift off during use.
- 2-year limited warranty.

1796 4-Ton Stinger Jack Stands

Meet the latest ASME PASE safety standards and feature a wide range of locking heights and adjusting positions to provide a universal stand for most vehicles. The form-fit saddle design and wide base ensures stability.

- Lifting range of 15-1/2" to 23-13/16".

Specifications	5302	5303
Capacity	2-1/4 ton	3-ton
Lifting range	5" to 18"	5-3/4" to 18-1/2"
Saddle dia.	4"	4"
Frame height	6-1/2"	6-1/2"
Handle Length	39-1/2"	39-1/2"
Floor space	13-1/2" x 24-1/2"	13-1/2" x 24-1/2"



1511B



1505B



1512



1510B

5-Ton and 10-Ton Air/Hydraulic Service Jacks

- Bring the versatility of air-assist operation to your shop's lifting tasks.
- Huge front wheels mounted in bearings provide trouble-free service life. Rugged steel frame members.
- Rear swivel casters make spotting the jack easy. Spring-loaded handle may be locked in three positions, from horizontal to vertical.

1507B
5-ton air/hydraulic service jack

1511B
10-ton air/hydraulic service jack

Specifications	1507B	1511B
Capacity	5 ton	10 ton
Air pressure	80–120 PSI	80–120 PSI
Lifting range	5-7/8" to 22"	6-3/8" to 22"
Saddle dia.	6-5/8"	5-3/4"
Overall reach	87"	90"
Frame height	8"	10"
Handle length	40"	45"

5-Ton and 10-Ton Service Jacks

- A built-in safety overload prevents using the jack beyond its rated capacity.
- Convenient foot pedal speeds the lifting operation. Handle lock and release control are located on top of the handle. Handle can be locked into any position from vertical to horizontal.
- Both models have a spring-loaded 40" handle.

1505B 5-ton service jack
1510B 10-ton service jack

20-Ton Capacity Service Jack

- Low-profile stance and extended height add to versatility.
- Wheels and swivel casters feature internal bearings.
- Either the foot pedal or jack handle may be used for pumping action. Counter-balanced, spring-assisted handle has a three-position lock.

1512 20-ton service jack

Specifications	1505B	1510B	1512
Capacity	5-ton	10-ton	20-ton
Lifting range	6" to 22"	6-1/4" to 22"	7-1/2" to 24"
Saddle dia.	5-1/8"	6"	7-1/2"
Overall reach	47"	51"	97"
Frame height	7-3/4"	9-3/4"	10-1/4"
Handle Length	43"	43-1/4"	42"
Floor space	14-3/4" to 56"	18" to 60"	18-1/8" to 61-3/8"

5214

4-Ton Capacity Fork Lift Jack

- 8,000 lb. capacity with a low starting height of 2-5/32".
- 10,000 lb. capacity (5 tons) when lifting from cylinder saddle—ideal for agriculture and industrial applications.
- Unique shape of primary saddle allows for handling of all lift truck configurations with flat or edged surfaces.
- Features include high-quality seals, chrome-plated internal components, and high-strength steel construction.
- Secondary lifting surface feature.
- Complies with ASME-PALD.
- Lifting Height: 2-5/32 – 17-15/16".



1540

4-Ton Capacity Fork Lift Jack

- 8,000 lb. capacity with a low starting height of 2-5/8".
- Two-position lift pad permits handling of all lift truck configurations with flat or edged surfaces.
- Minimum low lift: 2-1/4".
- Maximum high lift: 16-1/4".
- Features include high-quality seals and high-strength steel construction.
- Handle stop makes for easy maneuverability.
- 30" long handle.



3- and 6-Ton Capacity Ratcheting Jack Stands

- Jack stands feature a formed steel frame for strength and long life, and rolled base edges that resist sinking into soft ground or asphalt.
- Recessed column saddle for acceptance of vehicle panel rail (pinch weld).
- Dual purpose handle serves as carrying handle and column release.
- Investment cast rack bar for long life strength.
- Covered by OTC Lifetime Warranty®.

1736A Pair of 6-Ton Jack Stands.
Height Range of 15-1/2" to 24-1/2".

1733A Pair of 3-Ton Jack Stands.
Height Range of 12-1/2" to 18-1/2".

5373



OTC Stinger 3, 4, 6 and 12-Ton Jack Stands

- Formed and welded steel base for strength; self-locking ratchet handle cannot be released under load. Durable baked enamel finish resists corrosion.
- Stands conform to ANSI PALD load rating standard; factory tested before shipment.

5372 Pair of 3-ton jack stands. Base: 8-1/4" x 7-1/2". Height range: 12" to 17-11/16".

1796 Pair of 4-ton jack stands. Base: 11-7/16" x 10-3/8". Height range: 15-5/16" to 23-13/16".

5373 Pair of 6-ton jack stands. Base: 11-9/16" x 10-3/8". Height range: 15-5/8" to 23-11/16".

1784D Pair of 12-ton jack stands. Base: 12-1/8" x 10-7/8". Height range: 17-1/2" to 27-1/2".



1774B

10-Ton Capacity Ratcheting Jack Stands (pair)

- These ratcheting jack stands are highest quality steel and factory tested to ANSI PALD standards.
- The form-fit saddle design and 12" x 14" base ensures stability.
- Height range is 20" to 31-1/2".

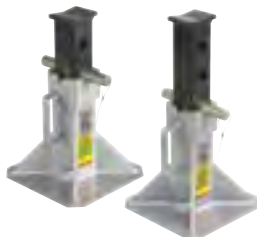

1780

22-Ton Capacity Jack Stands

- Height range is 13-7/8" to 19-7/8".
- Saddle size 3" x 3-3/4".
- Pin-style (non-ratchet) three positions, 3" intervals.
- Reinforced collar to meet newest ANSI PALD test standards.
- 11" flat base prevents sinking into the surface.

1783

Heavy-Duty 20-Ton Capacity Adjustable Support (One only)

- Designed for the really big service jobs. Rugged steel construction, and large 15-1/2" square base will satisfy support requirements up to 40,000 lbs.
 - Features include 4-point adjustment. Height range is 15-1/4" to 24". Saddle diameter is 6".
 - Covered by OTC Lifetime Warranty®.
- Note: Recommend use in pairs.



1778B

12-Ton Capacity Low profile Jack Stand (One only)

- Spun steel base won't dig or sink into asphalt or sand.
 - Height range of 19" to 29-1/2".
 - Covered by OTC Lifetime Warranty®.
- Note: Recommend use in pairs.



1779B

12-Ton Capacity High profile Jack Stand (One only)

- Spun steel base won't dig or sink into asphalt or sand.
 - Height range of 33-3/4" to 44-1/4".
 - Covered by OTC Lifetime Warranty®.
- Note: Recommend use in pairs.

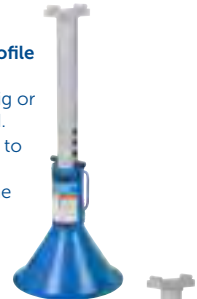

Extension Tubes for 1778B and 1779B Jack Stands

543751

Extension Tube Height range of 19" to 29-1/2"

543752

Extension Tube Height range of 33-3/4" to 44-1/4"



543751

543752

1781B

4,000 lb. Capacity Underhoist Tripod Stand

- Ideal for undercar maintenance. An ACME take-up screw precisely positions and secures the support stand in place.
- Height range of 65-3/4" to 74-5/8".

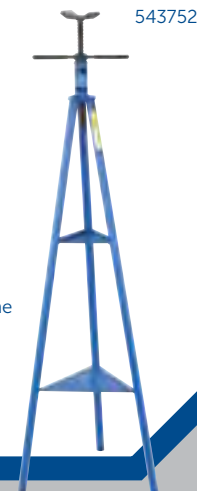

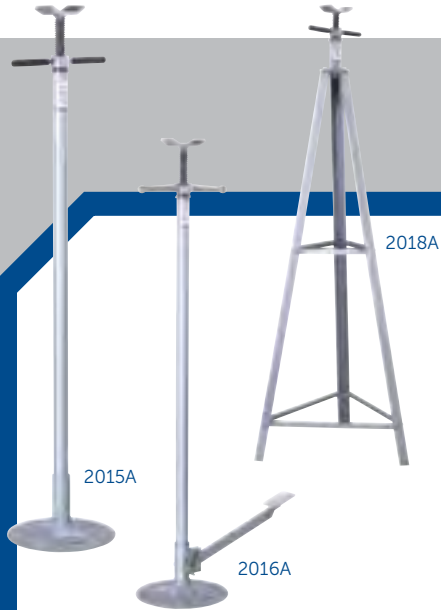

Tripod and Underhoist Stands

2018A 4,000 lb. Capacity Underhoist Tripod Stand

Lifting height of 58-7/8" to 91-5/8"; saddle measures 3-1/4" x 3-1/4".

- 24" x 24" x 24" tripod base.

2015A 1,500 lb. Capacity Underhoist Stand

Lifting height of 54-1/4" to 80-3/4"; saddle measures 5-1/4" x 1-1/4".

- 11-7/8" dia. base.

2016A 1,500 lb. Capacity Underhoist Stand with Foot Pedal

Foot pedal actuated lifting mechanism.

- Lifting height of 54-1/4" to 80-3/4"; saddle measures 5-1/4" x 1-1/4".



1572

Car Dolly (3,600 lbs., capacity pair)

- Innovative patent-pending design — clamps directly to pinch welds to prevent slippage during use.
- Independent units eliminate the need to adjust dolly width for different vehicle designs.
- Each unit has an independently adjustable threaded lift saddle with rubber pads to protect the vehicle frame.
- Universal design for use on all vehicle types without additional adapters.
- Provides easy movement of FWD vehicle after removal of drive train.
- The material on the 5" casters is polypropylene.
- Each unit has 1,800 lbs. capacity (3,600 lbs., pair) with low height of 9" and high of 14".
- May be used with or without tires on vehicle.



Shown folded

1734A

300 lb. Capacity Heavy-Duty Wheel Step

- Tire-mounted wheel step provides quick, easy access to under-hood components.
- Fits heavy-duty vehicles (Class 7/8).
- Adjusts to fit 22-1/2" to 24" wheel sizes.
- Non-skid platform surface.



Shown folded

1534A

300 lb. Capacity Passenger/Light Truck Wheel Step

- Provides quick, easy access to your vehicle's roof for loading/unloading cargo.
- Fits passenger and light trucks.
- Adjusts to fit 14" to 20" wheel sizes.
- Non-skid platform surface.
- Two-year warranty.



1580 (sold individually)

1580

1,500 lb. Capacity Easy Roller™

- Provides simple and efficient method of moving a disabled vehicle around a shop environment.
- Fits tread widths up to 12".
- 4 heavy-duty phenolic casters.
- 1,500 lbs. capacity per unit.
- Hydraulic lift mechanism with locking pin.



5090

Back Buddy™ II

- Remove, transport, service, and install heavy truck brake drums and hub assemblies.
- Fast-motion ratcheting jack with 14" of vertical lift.
- Pneumatic rear tires..
- Tilting mechanism to achieve the exact angle necessary for precise reassembly.
- Fold-down handle for open access to the work area.

Adapter Sets (sold separately)

513926 10 stud inboard hub & drum assemblies – 335 mm.

513927 10 hole outboard drums – 3/4" thick back plates

513925 5 and 6 spoke wheels

514644 8 stud inboard hub & drum assemblies

514645 8 hole outboard drums

514646 6 stud inboard hub & drum assemblies

514647 6 hole outboard drums

514648 Humvee/Hummer geared hubs



1545

Motorcycle/ATV Lift

- 1,500 lb. capacity and 17" long skids that will lift the largest, widest cruisers.
- Lowest clearance available, 3-1/2" at lowest level, with a wide lift range of 3-1/2" to 16-3/4".
- Removable handle provides 360° access to load.
- Features also include foot pedal release, locking rear casters, automatic safety lock, and two ratcheting tie down straps for safety.

5017A Brake Drum Dolly

- Remove, install, and transport truck brake drums without physically having to lift them.
- Works on 15" and 16-1/2" drums found on most Class 7 and 8 tractor and trailer brake systems.
- Heavy-gauge steel construction, ten-inch pneumatic tires, and adjustable handle.
- Covered by OTC Lifetime Marathon Warranty®.



1543 Brake Drum Dolly

- Removes, installs, and transports truck brake drums without physically having to lift them.
- Works on all 15" and 16-1/2" drums found on most class 7 and 8 tractor and trailer brake systems.
- 6" height adjustment aids installation.
- Heavy-gauge steel construction, 8" tires, and 36" handle.



5105B 1,100 lb. Capacity High-Lift Dual Wheel Dolly

- Effortless air-powered hydraulic lift system for a variety of applications.
- 0 to 42" lifting range.
- Six-inch lateral adjustment.
- Tilt adjustment of +15° to -8° ensures easy alignment.
- Features four swivel casters, two locking, for enhanced mobility.

Easy Lever Wheel Dollies

- Gives technicians the leverage they need to easily remove or install truck tire-and-wheel assemblies.
- Heavy-duty construction capable of toting 300 pounds.
- Onboard rollers that make stud-hole alignment a snap.
- Spring-loaded kickstand for handy parking.
- Two models that, together, can accommodate tire diameters from 24 to 48 inches.
- Rugged tubular steel construction.

5096A Heavy-duty Easy Lever Wheel Dolly. With a width of 26", this dolly handles tire diameters of 36" to 48".

5095A Easy Lever Wheel Dolly. With a width of 22", this dolly handles tire diameters of 24" to 36".



5100 Wheel Mate™

- Enables truck technicians to easily remove, install, rotate, and transport single tire-wheel assemblies.
- Internal ratcheting jack with 14 inches of vertical travel—almost a foot higher than conventional dollies.
- U-shaped chassis that provides close, unhindered access to work area.
- A design that accommodates—and securely holds—almost any truck wheel, including wide-based singles, without restraining chains.
- Heavy-duty ball-bearing wheels mounted under ball-bearing swivel casters for maximum maneuverability.
- Foot-operated wheel lock.
- Rugged structural steel tubing construction that meets the demands of the toughest shop environments.



5082 Wheel Tipper

This heavy-duty wheel tipper makes handling those hard-to-manage truck tires easy. To use the wheel tipper, simply deflate the tire and break the bead, then hook the wheel tipper to the rim of the wheel. The wheel tipper makes an otherwise tough task effortless.

- Designed for both aluminum and steel wheels won't damage wheel rim.



1770A 1,500 lb. Dual Wheel Dolly

- Hydraulic jack provides almost 5' of lift and tilts wheel assembly 4° to prevent damage to wheel seal.
- Independent lifting rack provides maximum stability; rollers won't catch on load.
- Swivel casters for easy maneuverability.
- Floor space is 45" by 41".
- 6' chain holds load in place.
- Covered by OTC Lifetime Marathon Warranty®.



1769A Truck Dual Wheel Dolly

- This 1,500 capacity dolly will remove, transport, and replace dual wheel and tire assemblies without strain or struggle.
- Swivel casters, 3-1/2" front and 3" rear, provide easy maneuverability.
- Floor space is 43" by 42".
- No. 1769A hydraulic jack provides over 6-1/2" of lift and tilts wheel assembly 7° to prevent damage to wheel seal.
- Includes a 6' support chain to hold load in place.



FOR PRODUCT
VIDEOS VISIT
OTCTOOLS.COM



6000 lb. Revolver® Diesel Engine Stand

- 96-to-1 ratio worm and gear set rotates components 360°; handle locks in any position.
- Integral 12-ton jack raises the work to provide the swing radius needed for clearance.
- Two front wheels and two rear casters provide mobility.
- Universal adapter assembly permits use with a wide variety of mounting plates.
- Covered by OTC Lifetime Warranty®.

1750A Revolver diesel engine stand with No. 205061 universal engine adapter assembly.

1750 Engine stand without universal engine adapter assembly. Revolver® Engine Adapter Plates

You can order just the plates you need for the engines you work on. The universal adapter assembly is required for mounting all plates to the stand.

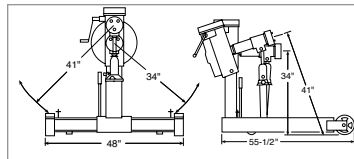

Engine Plates	
205061	Universal Adapter Plate Assembly. Included with 1750A engine stand. (Must be used with all plates below.)
J-29109-J	Adapter plate to accommodate adapters for Kent-Moore engine stand.
Detroit Diesel	
205058*	For Detroit engines: 53 series in-line 6 cyl., 6V & 8V; 71 series in-line 6 cyl., 6V, 8V, & 12V; 92 series 6V & 8V; 8.2 liter V-8.
52871*	For coach 6V and 8V series 71 Detroit Diesel.
218504*	For Detroit series 60 in-line 6-cylinder engines.
Detroit Allison	
208160*	Allison transmission mounting plate for transmission Nos. AT500, MT600, MT 6-speed, VH, VS, and V730.
61373*	Allison transmission adapter plate for transmission series HT-750, CLBT, HT-740D, CR/DR, and HT-750CT.
Cummins	
205059*	For Cummins engines: All NH, NTC, NTE, N14 855 series in-line 6 cyl; 378 series V6; 504, 555, & 903 series V8; KT 1150 series in-line 6 cyl., L10.
61405*	For Cummins L-10 and M11 series engines. Plate attaches to the left side of engine for complete tear down.
218098	For Cummins "B" series 5.9L in-line 6 cyl. engines.
218099*	For Cummins "C" series 8.3L in-line 6 cylinder engines.
Caterpillar	
205060*	For Caterpillar engines: Nos. 1673, 1674, 1693, 3306, & 3406 in-line 6 cyl.; Nos. 1100, 3208, and 3408 V8.
217687*	For Caterpillar 3114, 3116, and 3176 in-line 6 cylinder and C12 engines.
Mack	
205101*	For Mack engines: All 672, 673, 675, & 711 series in-line 6 cyl.
206629*	For Mack engines: V8 1000, E6, & E7 in-line 6 cyl.
528858*	For Mack 865, and 868.
International Harvester	
206386*	For International Harvester engines: DT-466 (2004 & Earlier), DT-360, DT408, 7 530 in-line 6 cylinder; DV-550, MV-404, MV-446, V304, V345, V392, 4-152, 4-196, 4-194; 9.0 liter 7 T444E V8; and Ford 6.9L, 7.3L DIT.
528856*	For IH300 & 400 Series.
528868*	For International VT365.
Ford	
61681*	For mounting Ford 6.6L/7.8L engines.
206386*	For Ford 7.3 engines.
Volvo	
528853*	For Volvo TD67 and TD71 engines.
John Deere	
528859*	For JD 400 and 500 engines.
528861*	For JD Powertech 4.5L & 6.8L.
528863*	For JD 8995 V6, must be used with 528859.



*NOTE: Must be used with 205061 univ. adpt. plate assembly. Each engine mounting plate includes all the necessary hardware and an engine application chart.

ENGINE STANDS / ENGINE SUPPORT BARS SHOP EQUIPMENT

1735B

2,000 lb. Capacity Heavy-Duty Motor-Rotor® Repair Stand

- Handles a wide variety of engines, transmissions, torque converters, and rear axles from trucks, tractors, and construction machinery.
- The 50:1 ratio gearbox allows full rotation of mounted unit with just a turn of the crank and locks in position. Easily maneuvered when loaded.
- To ensure engine stability in all positions, this repair stand is equipped with a positive-crank handle locking mechanism.
- Twin-post design, featuring laterally adjustable, 3 position outboard support; provides an extremely stable work-holding unit.
- Locking rear wheels anchor stand in position.
- Covered by OTC Lifetime Warranty®.

206391 6.0L and 6.4L Ford engine adapters. (Works with both the OTC 1735, 1735A and 1735B.)

206392 Ford 6.7L Engine Adapter for 1735B HD Rotor Repair Stand.



206391

206392

1726A

1,000 lb. Capacity Engine Stand

- A time saver for passenger car and light truck engine rebuilding or repair. Four adjustable attachment arms make engine mounting fast and easy.
- Engine can be rotated a full 360° with a turn of the handle; a locking pin secures the work in any of eight positions.
- Two rear wheels lock tightly to anchor the stand in place.
- Easy one-bolt disassembly for transport of stand.
- Covered by OTC Lifetime Warranty®.

Specifications:

Height to center line – 28"
Length – 46"
Width – 35-1/2"
Handle length – 24"



60796

60796 Drip pan (ABS material) for No. 1726A.

Engine Support Bars

Unique, innovative design featuring...

- Cutting edge, design self-centers load to prevent tipping on inclined surfaces.
- Smooth sliding legs adjust easily to different vehicle widths.
- PVC-coated support legs don't scratch vehicle surfaces.
- "Quick Connect" third-point bar (No.1725) makes setup a snap.
- Spinner handle enables lightning fast adjustment.

1723

Engine support bar (2-Point), 500 lb. capacity

1725

Engine support bar (3-Point), 700 lb. capacity



1725



1723

1735B with engine



1735B

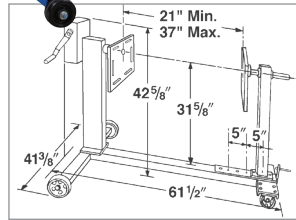

4324

Engine Support Bar

- 1,100 pound capacity.
- Rubber padded support legs ensure stability during use.
- Tubular steel construction for long life.
- Adjustable width: 57" x 27".
- Features two hook assemblies for ease of use.
- Includes two 36" chain assemblies.

1812

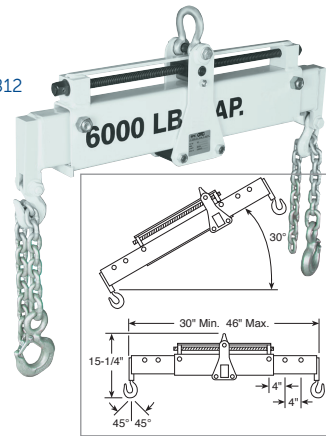

Load Leveler

- Improved design over conventional spreader bars.
- Carriage on main support beam moved by turning lead screw; this permits fine adjustment of the tilt angle of component being lifted.
- Turn lead screw manually or with air-powered tools.
- Spreader bar adjustment secured with locking bolts.
- Chain grade is 80.
- Covered by OTC Lifetime Warranty®.

1812 Load Leveler. Max. lifting capacity: 6,000 lbs.; distance between hooks: min. 30", max. 46".

1822 Load Leveler. Max. lifting capacity: 10,000 lbs.; distance between hooks: min. 36", max. 56".



1819, 1820

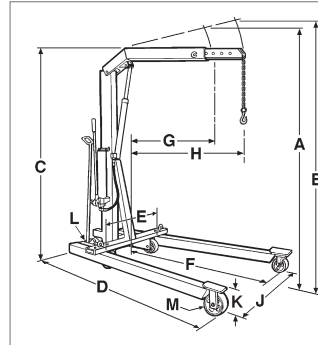

2,200 and 4,400 lb. Capacity Heavy-Duty Floor Cranes

- To conserve valuable floor space, crane folds into a compact package for storage.
- For "close-in" work, leg spread adjusts to clear vehicle's wheels, telescoping boom extension gives additional reach. Roller bearing mounted wheels and steering dolly provide ease of mobility.
- A two-speed hydraulic hand pump provides fast boom travel; descent of boom is under precise control of operator.
- Covered by OTC Lifetime Warranty®.

1819 2,200 lb. Capacity Crane. Has hydraulic hand pump and 16-7/8" lifting chain.

39610 1/4" steel chain grade 43, 18-3/8" long, 2,200 lb. capacity. Has safety hook on end. Use with 1819.

1820 4,400 lb. Capacity Crane. Has hydraulic hand pump and 18-3/8" lifting chain.

39611 5/16" steel chain grade 70, 19-3/4" long, 4,400 lb. capacity. Has safety hook on end. Use with 1820.

Specifications	1819	1820
Cap., boom retracted	2,200	4,400
Cap., boom extended	1,650	3,300
A Max. boom height, boom retracted	107"	111"
B Max. boom height, boom extended	117"	122"
C Overall height, boom horizontal	80"	82"
D Overall length	83"	89"
E Minimum throat width	24"	25"
F Inside leg length	54"	57-1/2"
G Effective boom reach (retracted)	33"	35-1/2"
H Effective boom reach (extended)	48"	50-1/2"
J Inside leg width (3-position)	24", 36", 48"	26", 40", 52-1/2"
K Leg height	8"	9-1/2"
L Dolly wheel diameter	5"	5"
M Wheel diameter	6"	8"
Height, folded	79"	86"
1819 Floor space folded	27" x 38"	
1820 Floor space folded	31" x 42"	



1813

Boom Capacity (lbs.)	Extended	Centered	Retracted
Description	4,000	5,000	6,000
A Maximum boom height	161-7/8"	150-11/16"	139-1/2"
B Minimum boom height	6"	17-3/8"	28-3/4"
C Overall height (boom horizontal)	87"	87"	87"
D Overall length*	129-1/8"	113-7/8"	98-1/4"
E Inside leg length	91-11/16"	76-1/8"	43-1/4"
F Effective boom horizontal reach	94-1/4"	78-3/4"	63-1/4"
G Outside leg width**	59-3/4"	57-3/4"	55-3/4"
H Boom swing	36"	31"	26"
J Inside leg width	35-3/4"		
K Leg height	9-1/16"		
M Wheel diameter	8"		
Dolly wheel diameter	5"		

* Legs in storage position: 80-7/8"

** Legs in storage position: 53-1/2"

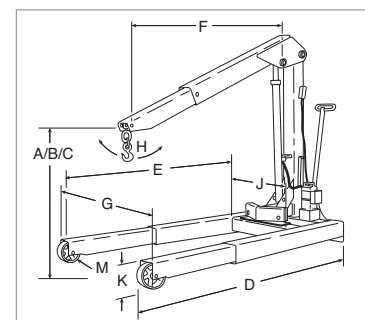

6,000 lb. Capacity Heavy-Duty Mobile Floor Cranes

- Three boom positions give capacities of 4,000, 5,000, and 6,000 lbs. to handle the biggest engines, and often the transmission right along with the engine! Usable reach is almost 92".
- Boom swivels for vertical and lateral positioning; legs extend to straddle the biggest tires.

1814 6,000 lb. capacity crane with electric/ hydraulic pump (115V) with remote motor control.

1813 6,000 lb. capacity crane with two-speed hydraulic hand pump.

FLOOR CRANES / LIFTING CHAINS SHOP EQUIPMENT



2,000 and 4,000 lb. Capacity Folding Floor Cranes

- Both of these cranes fold up for compact storage.
- Front wheels are 5-7/8"; rear casters 3-1/2".

2002 2000 lb. capacity crane with a reach of 24" to 36"

2004 4000 lb. capacity crane with a reach of 26" to 48"

Lifting Chains for Floor Cranes

- For use with floor cranes only; not recommended for overhead hoists or lifts.

38839 1/4" steel chain, 56-1/2" long, 2,000 lb. capacity. Has safety hook on both ends. Use with No. 205049.

38840 5/16" steel chain, 65-3/4" long, 4,000 lb. capacity. Has safety hook on both ends. Use with No. 205050.

31609 1/4" steel chain, 56-1/2" long, 2,000 lb. capacity. With swiveling safety hooks on both ends. Use with No. 1805.

31800 5/16" steel chain, 65-3/4" long, 4,000 lb. capacity. With swiveling safety hooks on both ends. Use with No. 1806.

Alloy Chains for Overhead Lifts and Hoists

302941 5/16" alloy chain, 26-13/16" long, 4,000 lb. capacity. With safety hook on one end. Use on No. 1812.

302249 3/8" alloy chain, 28-3/8" long, 6,000 lb. capacity. With safety hook on one end.

302249



Specifications	2002	2004
Maximum capacity, boom extended	500 lbs.	1,000 lbs.
Maximum capacity, boom retracted	2,000 lbs.	4,000 lbs.
Maximum hook height, boom extended	94"	86-1/2"
Maximum hook height, boom retracted	87"	72-3/4"
Effective boom reach, boom extended	36"	48"
Effective boom reach, boom retracted	24"	26"
Leg width @ front wheels	25"	32-1/2"
Leg height	6-1/2"	7-3/4"
Floor space folded	16" x 17-1/2"	33" x 33-1/2"
Floor space unfolded	57" x 25"	70" x 33-1/2"

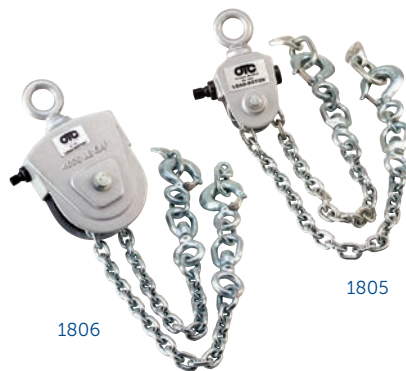

1806

1805

Load-Rotor® Positioning Slings

- Use with a floor crane. Engine, transmission, or other component is tilted or leveled by turning sling's 5/8" hex drive end with a common speed handle and socket.
- Makes engine removal and installation a snap, even in close quarters.
- For use with floor cranes only; not to be used with overhead hoists or lifts.

1805 2,000 lb. capacity Load-Rotor®. Has 56-1/2" long chain (1/4") and hook assembly with forged swiveling hook on each end. Pair of special lifting brackets included.

1806 4,000 lb. capacity Load-Rotor®. Has 65-3/4" long chain (5/16") and hook assembly with forged hook on each end. Pair of special lifting brackets included.



7100 4,000 lb. Capacity Lifting Brackets (pair)

- Attach directly to component for easy lifting; will take 1/2" diameter bolts.

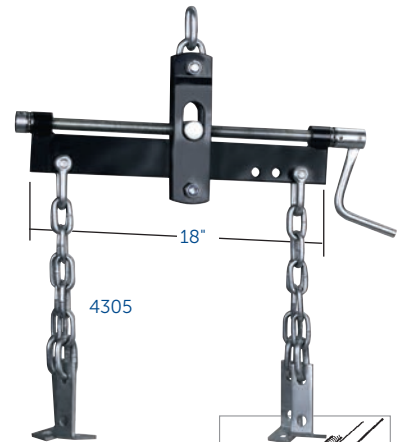

4305

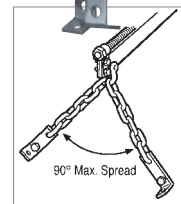

4305 1,500 lb. Capacity Engine Load Leveler

Designed to hook to a crane or hoist to handle and position large, bulky components.

- The horizontal tilt can be adjusted to compensate for off-center loads, or adjusted to a certain angle for a component being positioned.



Heavy-Duty Adjustable Slings

- For lifting and positioning engines, transmissions, etc. Each chain can be adjusted independently for length; plate design enables chain to be "short-hooked" for correct tilt.

205049 2,000 lb. capacity sling with 1/4" chain, 56" long

205050 4,000 lb. capacity sling with 5/16" chain, 65" long

38841 Plate only, use with any 1/4" or 5/16" alloy steel chain



1821
10-Ton Capacity, Air-operated Automotive Oil Filter Crusher

- Crushes up to four automotive filters (3-7/8" dia. x 9" high) at one time, in approximately 20 seconds. Engineered and built for dependable operation. Covered by OTC Lifetime Warranty®.
- 100% air operation eliminates electrical connections. Generous size of crushing chamber easily accommodates the largest automotive spin-on filters.
- Includes mounting stand. No wall mounting or time consuming installation required.



1877
25-Ton Capacity Heavy-Duty Oil Filter Crusher

- Handles the big filters (up to 6" dia. and 12-1/2" long) found in trucks, construction equipment, farm implements, etc. May also be used for automotive and light truck filters. It does it all!
- Crushes filters to 1/4 of original size, removing up to 95% of filter's oil capacity. Automatic cycle feature: load the filter, push a button, and walk away.
- Air/hydraulic pump works on standard shop air (requires 9 CFM at 100 psi). Special valving returns ram automatically at the end of each cycle. No electrical connections needed.
- Built-in floor stand (completely assembled). Whole unit requires just 5 square feet of floor space.
- Covered by OTC Lifetime Warranty®.



Shipped assembled

1896
25-Ton Capacity High-Speed Heavy-Duty/Automotive Oil Filter Crusher

- Automotive and heavy-duty filters up to 15-1/4" long and 6" diameter are crushed in approximately 8 to 16 seconds. Filters are reduced to 20% of original size, with 95% of residual oil removed.
- Automatic cycle feature lets you load the filter, push a button, and walk away.
- Powered by 2 hp electric/hydraulic pump, 230 volt, 20 amp, 60 cycle, single phase, 3,450 rpm. Has a 2-gallon reservoir.
- Built-in, heavy-duty floor stand with leveling pads is designed to accept a 30-gallon drum for oil drainage. Comes assembled. Covered by OTC Lifetime Warranty®.



**SEE PAGE 35
FOR OIL FILTER
WRENCHES**

Oil Filter Crusher Comparison Chart

No.	Tonnage	Pump	Crushing Time	% Oil Removed	Filter Size	Stand Dimensions
1821	10-ton	Air	20 Seconds	95%	Chamber: 8" x 8" x 9" H.	18-1/2" W x 24" D x 63-1/2" H
1877	25-ton	Air/Hyd.	80 Seconds	95%	6" Dia. - 12-1/2" Long	18-1/2" W x 30" D x 74-1/2" H
1896	25-ton	Elec./Hyd.	16 Seconds	95%	6" Dia. - 15-1/4" Long	27" W x 30" D x 78" H

Note: Crushing times are approximate; crushing times may vary depending on air pressure available, size of filter type of filter, etc.

Transfer Tankers

- Draining oil from a large displacement engine and getting it to your bulk storage container is a snap with OTC's Transfer Tankers.
- Used oil is collected in a reservoir, and then rolls smoothly on 4" free-wheeling casters to your storage location.
- Pump moves five gallons a minute through the 8-foot transfer hose to the 15-gallon reservoir.
- Handle is removable for easy storage.
- Screen attached to reservoir allows assembly to be stored on its side.
- Can also be used for transferring antifreeze.

5077A Low profile Transfer Tanker is only 7-1/2" from floor to top of reservoir. Comes equipped with an electric pump (No. 528093).

5097 Low profile Transfer Tanker is only 7-1/2" from floor to top of reservoir. Comes equipped with a pneumatic pump (No. 529966).



5077A



5097



1577
Low Profile Fluid Receiver

- Designed for receiving waste fluid during a wide range of repair jobs.
- Fluid capacity: 7.5 gallons.
- Constructed of polyethylene plastic for heavy-duty use—yet, only weighs 13 pounds.
- Low profile, only 5" high, it easily slides under passenger cars.
- Designed with four casters to provide efficient maneuverability.
- Suitable for cooling system repair jobs—can be used for antifreeze.
- Includes splash screen to prevent spillage and splashing.
- Two-year warranty.

5180
10-Ton Portable Hydraulic C-Frame Press

- Weighing less than 28 lbs, this durable press is portable for various applications, i.e., roadside maintenance services, industrial applications, marine, general automotive.
- For clamping, pressing and bending. Ideal for welding and metal fabrication.
- 9" Open-Throat® design.
- Couples to any 4- or 10-ton Porta Power pump.
- The base can be assembled to position the press either vertically or horizontally and can also be mounted to a bench.

Set includes: C-Frame press with base, adapters: V-pushing and ram pushing (9/16" and 3/4" dia. shanks), receiving insert, flat insert, storage case.



A	B	C	D	E	F	G	H
21-1/4"	13-3/4"	9"	8-1/2"	2-1/2"	1-1/2"	4"	4-1/4"

Hydraulic Bottle Jack Presses

- All bottle jacks have an overload valve built into them.

1823A
12-ton capacity press with a OTC bottle jack.

Stroke 6-1/4", 19 pump stroke to extend piston 1 inch.
Height with screw extension 19".

1824A
20-ton capacity press with a OTC bottle jack.

Stroke 7-1/2", 30 pump stroke to extend piston 1 inch.
Height with screw extension 20-1/2".

309111
20-ton capacity press (frame only).

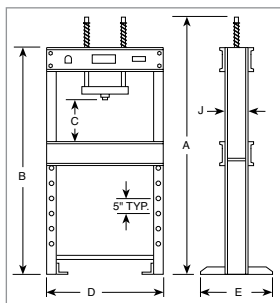

OTC No.	A	B	C	D	E	J
1823A	84-1/2"	72"	2" - 42"	28-3/4"	28"	4-3/8"
1824A	85-7/8"	72"	2" - 37"	37-1/2"	28"	7-3/8"

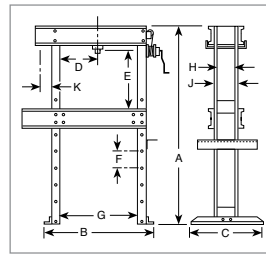

1825
17-1/2 Ton Capacity Heavy-Duty "Open Throat" Press

- Ram head moves side to side for off-center pressing; ram-to-work distance is adjusted by a forcing screw that is extended or retracted by a speed crank.
- "Open-throat" frame extensions make handling of bulky jobs possible outside of the press frame.
- This press does not have a lifting mechanism. If a lifting mechanism is needed, order 211407.
- Covered by OTC Lifetime Warranty®.
- Has No. 201832 hydraulic ram with 2" stroke, No. 4002 hydraulic hand pump, No. 9650 gauge, No. 9767 hose, adjusting screw, speed crank, ram cap, and pump mounting bracket.

211407 17-1/2 ton winch kit.

A	B	C	D	E	F	G	H	J	K	Floor Space
64"	28"	28"	17-7/8"	34-7/8"	3-3/8"	20"	4-1/4"	5"	4-3/8"	28" x 28"



1826

25-Ton Capacity Heavy-Duty "Open Throat" Press

- "Open throat" feature enables ram to be positioned outside of press frame for fast axle bearing removal and installation, as well as other tasks. Rugged press is covered by OTC Lifetime Warranty®.
- Press bed is raised or lowered with a hand crank, and a spring-return hydraulic ram is laterally adjustable for off-center work at full capacity.

1826

25-ton press. Includes No. 4016 hydraulic hand pump; No. 52025 hydraulic ram with 14" stroke; No. 9652 gauge; No. 303563 hose (3/8" ID x 8'); and pump mounting bracket.

1826A

25-ton press. Includes No. 4020 air/hydraulic pump; equipped the same as 1826.

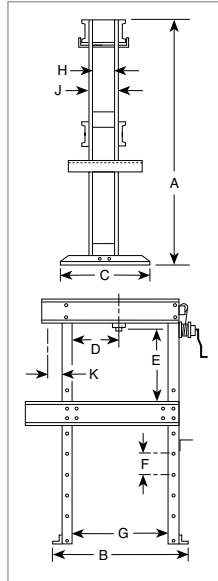

A	B	C	D	E	F	G	H	J	K	Floor Space
68"	43"	28"	3"-29"	6-7/8"-4-3/8"	4-1/2"	32"	5-1/2"	6-1/2"	7"	55-1/4" x 28"



1833

25-Ton Capacity Shop Presses

- Tough, economical press is ideal for pressing rear axle bearings, piston pins, and much more.
- Large 30" x 46" work area under ram makes positioning of even bulky work easy. Press bed is easily raised and lowered by a dependable lifting mechanism. Choice of model with hand- or air-driven hydraulic pump.

1833

25-ton press, complete with No. 4002 hydraulic hand pump; No. 9652 gauge; No. 24815 tee; No. 9767 hose (1/4" ID x 6'); hydraulic ram No. 51426 with 6-1/4" stroke; and 42733-WH2 pump mounting bracket.

1834

25-ton press, complete with air-driven No. 4020 hydraulic pump; No. 9652 gauge; No. 24815 tee; No. 9768 hose (1/4" ID x 8') and hydraulic ram with 6-1/4" stroke.

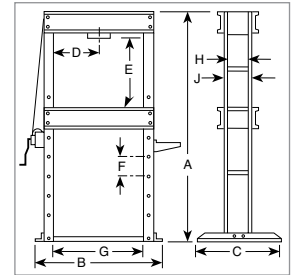

A	B	C	D	E	F	G	H	J	Floor Space
69-1/2"	40-1/2"	28"	3"-27"	5-3/4"-46"	4"	30"	5-1/2"	6-1/2"	48-1/2" x 28"

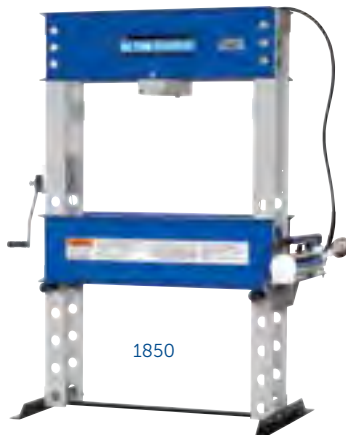
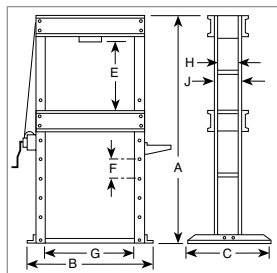

1850

55-Ton Capacity Economy Shop Presses

- Wide 10" throat opening between lower bolsters
- Durable steel frame resists buckling and bending. Covered by OTC Lifetime Warranty®.
- Hand-operated winch and cable mechanism adjusts lower press bolster.

1850

55-ton press. Includes No. 52457 hydraulic ram with 6-1/4" stroke; No. 4016 hydraulic hand pump; No. 9651 gauge; No. 9767 hose (1/4" ID x 6'); and pump mounting bracket.

1851

55-ton press. Includes No. 52457 hydraulic ram with 6-1/4" stroke; No. 4020 air/hydraulic pump; No. 9651 gauge; No. 9767 hose (1/4" ID x 6'); and pump mounting bracket.

A	B	C	E	F	G	H	J	Floor Space
70-3/4"	47-1/2"	28"	6-1/8"-41-1/8"	5"	35"	7-1/16"	10"	55-1/2" x 28"



1845

55-Ton Capacity Heavy-Duty Presses

- Side-to-side positioning of ram allows full capacity pressing along entire bolster length without buckling or bending. Covered by OTC Lifetime Warranty®.
- Hydraulic ram features 13" of stroke. Choice of hydraulic power units.

1845

55-ton press. Includes single-acting ram No. 52380 with 13" stroke; No. 4044 electric/hydraulic pump; No. 9651 gauge; No. 303563 hose (3/8" ID x 8'); and pump mounting bracket.

1846A

Same as No. 1845 except has No. 4016 hydraulic hand pump and single acting ram No. 65458 with 10-1/8" stroke.

1847

Same as No. 1845 except has a No. 4022 air/hydraulic pump and a No. 9781 hose (3/8" ID x 10').

1872

55-ton press. Includes double-acting ram No. 51682 with 13" stroke; No. 4046 electric/hydraulic pump; No. 9651 gauge; No. 36887 hoses; and pump mounting bracket.

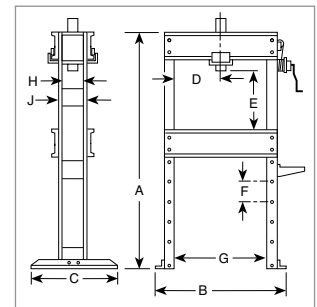

A	B	C	D	E	F	G	H	J	Floor Space
72"	48-1/2"	36"	3-1/4"-32-3/4"	6"-42"	6"	36"	6-3/4"	8"	56-1/2" x 36"

*Lateral head movement.

100-Ton Capacity Economy Shop Press

- Large 35" opening between press uprights allows easy handling of large gears, shafts, sprockets, and other components serviced in truck, construction, and agricultural equipment shops. Covered by OTC Lifetime Warranty®.
- Hand-operated winch and cable mechanism gives operator precise control in adjustment of lower press bolster to any height.

1854

100-ton press. Includes hydraulic ram No. 52434 with 10" stroke; No. 4044 electric/hydraulic pump; No. 9651 gauge; No. 9768 hose (1/4" ID x 8'); and pump mounting bracket.

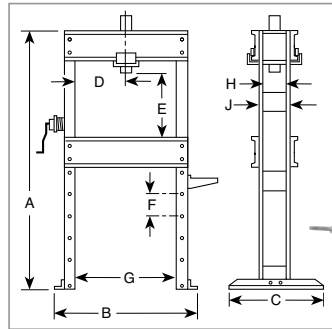

1854

A	B	C	D	E	F	G	H	J	Floor Space
86-5/8"	47-1/2"	28"	17-1/2"	9-5/8"-49-5/8"	8"	35"	6-3/8"	10"	55-1/2" x 28"



1857



1858

100-Ton Capacity Heavy-Duty Shop Presses

- Wide open uprights allow easy positioning of bars and shafts for straightening or bending.
- Upper bolster can be lowered for convenient positioning during repetitive jobs.
- Ram head glides smoothly on rollers for easy horizontal adjustments; rugged press frame will withstand a full capacity load with the ram head in any position across the upper bolster.
- Covered by OTC Lifetime Warranty®.

1857

100-ton press. Includes single-acting No. 52434 ram with 10" stroke; No. 4008 hydraulic hand pump; No. 9651 gauge; No. 9781 hose (3/8" ID x 10'); and pump mounting bracket.

1858

Same as No. 1857, except has double-acting No. 51683 ram with 13" stroke; No. 61217 3-phase, 220V, 3450 rpm electric/hydraulic pump; and two No. 9769 hoses.

1858-1P

Same as No. 1858, except it has a No. 4064 2-stage, 1-phase hydraulic pump.

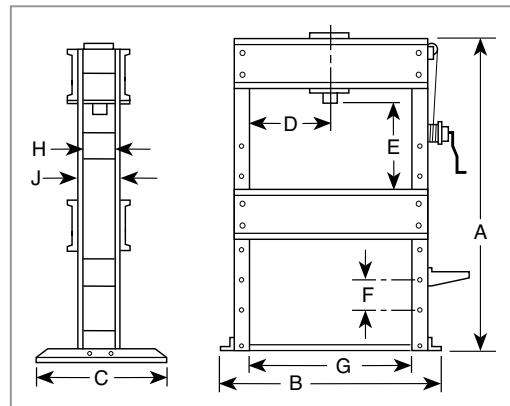

A	B	C	D	E	F	G	H	J	Floor Space
77-1/4"	64"	36"	7"-43"	2"-42"	8"	50"	8"	10"	36" x 78-1/4"

*Lateral head movement. Frame shipped assembled.

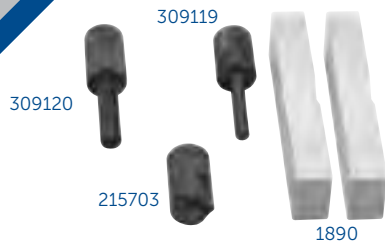

Accessory Set for Bottle Jack Presses

- 1879** Accessory set for 12-ton and 20-ton bottle jack presses. Includes;
- 1890** 9" long V-block set
- 215703** 1-1/2" dia. V-pushing adapter
- 309119** 3/4" dia. pushing adapter
- 309120** 1" dia. pushing adapter

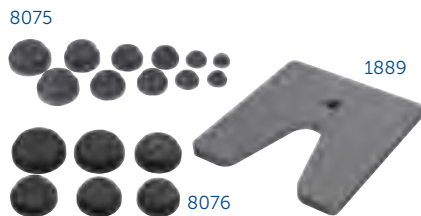

25-Ton Press Accessory Sets

- 8075** Step plate adapter set
- 8076** Step plate adapter set
- 1889** V-throat press plate. Dimensions are 11 5/8" x 14-1/2" and 3/4" thick.

Note: See page 125 for sizes of step plate adapters in sets.



17-1/2 Ton Press Accessory Sets

- 8075** Step plate adapter set
- 8076** Step plate adapter set
- 1888** V-throat press plate. Dimensions are 9-1/4" x 10" and 3/4" thick.

Note: See page 125 for sizes of step plate adapters in sets.

Accessories for 100-Ton Capacity Presses

- 50392** Straightening fixtures (pr.)
- 1893** V-blocks, 14" long (pr.)
- 21332** Pushing adapter (must be used with reducing adapter).
- 36469** V-pushing adapter (must be used with reducing adapter).
- 43563** Reducing adapter (for double-acting ram).
- 43562** Reducing adapter (for single-acting ram, not pictured).



**1880
17-1/2 -Ton Press Accessory Set**

- Adapters and accessories attach to ram's forcing screw or are used on press bed to support work.
- Set includes:

- 1123** Bearing pulling attachment
- 201923** Ram pushing adapter with a 1/2" dia. shank
- 201454** Ram pushing adapter with a 3/4" dia. shank.
- 34806** V-pushing adapter
- 1890** V-blocks (pair)

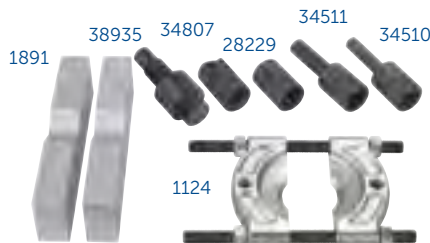

**1881
25-Ton Press Accessory Set**

- Adapters and accessories attach to ram's forcing screw or are used on press bed to support work.
- Set includes:

- 1124** Bearing pulling attachment
- 34510** Ram pushing adapter with 3/4" dia. shank
- 34511** Ram pushing adapter with 1" dia. shank
- 34807** V-pushing adapter
- 1891** 11-1/2" long V-blocks (pr.)
- 28229** Ram forcing cap
- 38953** Threaded adapter

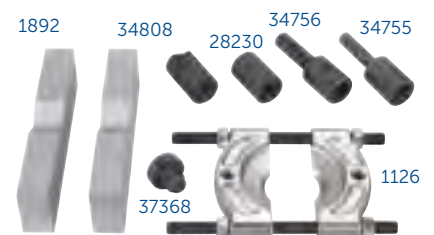

**1882
55-Ton Press Accessory Set**

- Accessories attach to ram's forcing screw or support work on press bed.
- Set includes:

- 1126** Bearing pulling attachment
- 34755** Ram pushing adapter with 1" dia. shank
- 34756** Ram pushing adapter with 1-1/4" dia. shank
- 34808** V-pushing adapter
- 1892** 14" long V-blocks (pr.)
- 28230** Ram forcing cap
- 37368** Threaded adapter – for single acting only
- 38954** For 1872 double acting press



Accessories for 150-Ton Capacity Shop Presses

- 44458** Pushing adapter with 2-1/4" dia. shank
- 44457** V-pushing adapter

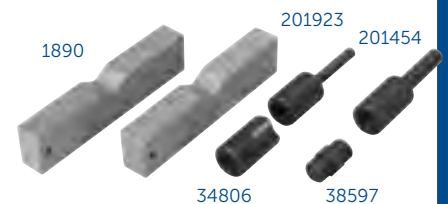

**1899
10-Ton Capacity Press Accessory Set**

- Adapters and accessories are attached to the ram's forcing screw or used on the press bed to support the work. Set includes:

- 201923** Ram pushing adapter with a 1/2" dia. shank
- 201454** Ram pushing adapter with a 3/4" dia. shank
- 34806** V-pushing adapter
- 1890** V-blocks (pair)
- 38597** Adapter

OTC 9300 STINGER SERIES BOTTLE JACKS GIVE YOU LIFTING RANGE FROM 2 TO 50 TONS.

- Forged base and cylinder to ensure strength and eliminate leaks.
- Chromed pump piston and ram for additional rust resistance.
- In-line design for increased ease of use in positioning and operation.
- Includes free seal kit with each unit to extend product life.
- ANSI/PALD compliant.



OTC 9300 Stinger Series Bottle Jacks

Cap. (tons)	Stroke	OTC No.	Retracted Height min.	Length of Screw Extension	Height with Screw Extension	Pump Strokes to Extend Piston One Inch	Saddle Dia.	Base Size	Carry Handle	Weight
2	4-5/8"	9302	7"	2-3/8"	14"	8	13/16"	4-5/16" x 2-9/16"	No	5.7 lbs.
3	4-1/2"	9303	7-1/2"	2-9/16"	14-9/16"	13	15/16"	4-9/16" x 2 7/8"	No	7 lbs.
5	4-13/16"	9305	7-13/16"	3"	15-5/8"	20	1-1/8"	5-3/16" x 3"	No	9 lbs.
8	4-15/16"	9308	7-13/16"	3"	15-3/4"	21	1-3/8"	6" x 3-9/16"	No	13.2 lbs.
12	6"	9312	9-3/8"	3-1/4"	18-5/8"	21	1-3/4"	6-9/16" x 4-3/16"	Yes	18.9 lbs.
12	3-11/16"	9314	7-1/16"	2-7/8"	13-5/8"	21	1-3/4"	6-9/16" x 4-3/16"	Yes	16.1 lbs.
20	6-7/8"	9320	10-5/8"	2-15/16"	20-7/16"	28	2-1/8"	7" x 4-11/16"	Yes	28.6 lbs.
20	3-7/16"	9322	7-3/16"	1-11/16"	12-5/16"	25	2-1/8"	7" x 4-11/16"	Yes	22.5 lbs.
30	6-5/8"	9330	11"	N/A	17-5/8"	41	2-1/2"	7-11/16" x 6"	Yes	43.2 lbs.
50	7-3/16"	9350	11-3/4"	N/A	18-15/16"	74	2-1/2"	8-11/16" x 7"	Yes	76.5 lbs.



5213A



5221A



5213TA



4313C



4321C

Bottle Jacks

- Base, pressure cylinder, and oil reservoir form one internal part, which results in a stronger jack.
- Piston never contacts cylinder, so pressure will be absorbed and not damage jack if vehicle tilts.
- The No. 5213T is telescopic, allowing for very low initial height with high lifting.

5213A – 12-Ton Bottle Jack.

5221A – 20-Ton Bottle Jack.

5213TA – 12-Ton Telescopic Bottle Jack.

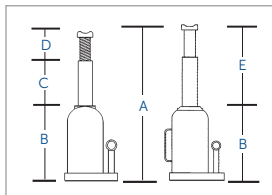

Bottle Jack Dimensions

Jack	A	B	C	D	E
5213A	17-3/4"	8-7/8"	5-1/4"	3-1/2"	–
5221A	18-1/32"	9-1/4"	8-3/4"	3-5/8"	–
5213TA	22-5/16"	9-7/8"	–	–	12-7/16"

Air/Hydraulic Bottle Jacks

- Operate manually or pneumatically, 100 PSI minimum air pressure required.

4313C

12-ton air-assist bottle jack; lift range 9-1/2" to 18-3/8", stroke 6-1/8".

4321C

20-ton air-assist bottle jack; lift range 9-7/16" to 17-11/16", stroke 5-7/8".

No.	Cap.	Min. Height	Max. Height	Stroke	Screw/Adapter	Air Pressure	Base Area
4313C	12	9-1/2"	18-3/8"	6-1/8"	2-3/4"	100-200 psi	6-3/8" x 7-5/8"
4321C	20	9-7/16"	17-11/16"	5-7/8"	2-5/16"	100-200 psi	8-1/32" x 7-1/16"



1513B – 4-Ton



1515B – 10-Ton

Collision Repair Sets, Stinger Series 4- and 10-Ton

- Very competitively priced, yet high quality sets include single-speed hydraulic hand pump, hose, and ram.
- Components snap together for quick setups to apply pushing, spreading.
- Components include: hydraulic pump, hose, and ram; ram flat base; extension tubes (4); 1/2-ton spreader; tube coupling; ram toe; wedge head; serrated saddle; flex head; plunger toe; 90° wedge head; storage case. The case for the 10-ton set has wheels for mobility.

1513B 4-ton collision repair set. Has single speed hydraulic hand pump and ram with 4" stroke.

1515B 10-ton collision repair set. Has single speed hydraulic hand pump and ram with 6" stroke.



1517B – 4-Ton



1519B – 10-Ton

Collision Repair Sets, OTC Series 4- and 10-Ton

- We've matched our OTC hydraulics with versatile tooling.
- Components snap together, permitting you to apply pushing, spreading.
- Components include: hydraulic pump, hose, and ram; ram flat base; 1/2-ton hydraulic spreader; extension tubes (4); tube coupling; ram toe; wedge head; serrated saddle; flex head; plunger toe; 90° wedge head; storage case. The case for the 10-ton set has wheels for mobility.

1517B 4-ton collision repair set. Has single speed hydraulic hand pump (4000A) and ram (4082B) with 5" stroke.

1519B 10-ton collision repair set. Has two-speed hydraulic hand pump (4012A) and ram (4083C) with 6-1/8" stroke.

222618 6 ft. hose 1/4" NPT.



**5086
10-Ton Collision Repair Set**

- Exert hydraulic force just where it's needed to lift, spread, bend, or straighten. Handles the high-force jobs you face daily in trailer maintenance or other applications.
- Includes reliable components including 10-ton, 10-1/8" stroke hydraulic ram; air/hydraulic pumping unit; hydraulic hose; four snap-together extension tubes; extension tube coupling; serrated saddle; flat base; 90° wedge head; flex head; storage case.
- All set components are covered by OTC Lifetime Marathon Warranty®.



Hydraulic Spreaders

Included as standard equipment with our collision sets, these versatile hydraulic spreader tools are also available individually. Ideal for removing dents and creases, performing straightening jobs, or for use as a clamp. Makes working in tight spots easy.

- Maximum spread is 3-1/4".

9101B
1/2-ton spreader with 1/4" NPT ram half coupler

9102
1/2-ton spreader with 3/8" NPT ram half coupler

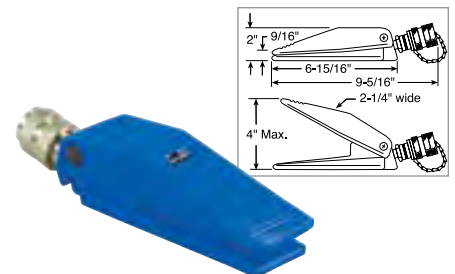

**4085
1-ton Capacity Hydraulic Spreader**

This hydraulic spreader is rated at a full 1-ton capacity at 10,000 PSI and that's enough for a wide variety of jobs. Working in tight spots is no problem—it needs only a 9/16" clearance to engage the jaws. With a big 4" spread, it's ready for a variety of applications: straightening work, removing dents and creases from sheet metal, or as a clamp. The device's spring-return jaws are made of high-strength alloy steel. It can be dead-ended at 4" spread under full load. Ideally suited to work with No. 4012 hand pump (not included).

THE OTC SERIES OF FLOW METERS

Unparalleled accuracy in testing hydraulic oil flow circuits for vehicles and machinery. All are protected by a durable steel case. Pressure accuracy is at +/- 1.6% of full scale. Due to their standard burst disc protection system, overpressure conditions prevent spillage of hydraulic fluid. All devices accommodate bi-directional flow and are CE marked as appropriate.



4277

50 gpm Mechanical Hydraulic Flow Meter

- Flow Accuracy to +/- 4% of full scale
- Measures flow from 4 to 54 gpm
- Pressure up to 6000 psi
- Fluid filled analog gage that dampens vibration
- Temperatures up to 230 deg F
- Reads flow in one direction
- No batteries required
- Port is 1-5/16" - 12 UN JIC Male
- 12.25" x 4.125" x 4.875"
- 14.5 lbs



4278

100 gpm Digital Hydraulic Flow Meter

- Flow Accuracy to +/- 1% of indicated value
- Measures flow from 2.5 to 100 gpm
- Pressure up to 6000 psi
- Digital display for flow, temperature, analog for pressure
- Temperatures up to 250 deg F
- Reads flow in both directions, pressure on the high side of valve
- Requires 1 9V battery (included)
- Port is 1-5/16" -12UN #16 SAE ORB
- 9.45" x 7.87" x 7.87"
- 14 lbs



4285

100 gpm Digital Hydraulic Flow Test Kit

- Includes OTC 4292 Digital Readout and OTC 4291 Flow Block with Loading Valve
- Flow Accuracy to +/- 1% of indicated value
- Measures flow from 2.5 to 100 gpm
- Pressure up to 6000 psi
- Digital display for flow, temperature, analog for pressure
- Reads flow in both directions, pressure on the high side of valve
- Require 1 9V battery (included)
- Port is 1-5/16" -12UN #16 SAE ORB
- 12.99" x 12.4" x 10.24"
- 17lbs



4290

16 gpm Flow Block

- Can be used with Digital Flow Meter Readout OTC 4292 included in OTC 4285 and OTC 4294
- Port is 1-1/16" -12UN #16 SAE ORB
- Flow range from 1 to 16 gpm
- Max pressure 6000 psi



4291

Flow Block with Loading Valve

- Can be used with Digital Flow Meter Readout OTC 4292 included in OTC 4285 and OTC 4294
- Knob allows for pressure loading/restriction
- Port is 1-5/16" -12UN #16 SAE ORB
- Flow range from 2 to 100 gpm
- Max pressure 6000 psi



4294

Deluxe 100 gpm Hydraulic Flow Measurement Set

- Comprised of OTC 4290, OTC 4291, OTC 4292, Long Cable and Hose Set and Short Cable
- Case included



4292

Hydraulic Flow Measurement Digital Readout

- For remote flow measurement by using Flow Blocks OTC 4290 or OTC 4291
- Included in OTC 4285 and OTC 4294
- Digital display for flow, temperature, analog for pressure



573295

Long Cable and Hose Set

- 20 feet long
- Flow, Temperature & Pressure



573296

Short Cable

- 6 1/2 feet long.
- Flow & Temperature



Hydraulic Rams for Collision Repair Sets

These premium quality rams are designed for long, trouble-free service. Backed by a lifetime warranty, they are ideal replacements for worn-out, leaky rams. They feature a special piston rod that permits their use with the snap-together components of OTC's collision repair sets, or with most similar competitive products.

4082B

4-ton ram with 5" stroke and special piston rod end designed to fit most collision repair set components.

4083C

10-ton ram with 6-1/8" stroke and special piston rod end designed to fit most collision repair set components.

Specifications

	4082B	4083C
Min. height	10-7/8"	14-5/8"
Max. height	15-7/8"	20-3/4"
Spring return	Yes	Yes
Rod end dia.	.86"	1.3"
Max. operating. Pressure	8,950	9,186
Oil cap. (cu. in.)	4.78	13.69
Oil port	1/4" NPT	1/4" NPT



4004

2-Speed Hydraulic Hand Pump

Use with single-acting hydraulic rams. Rugged all-metal construction. Maximum handle effort is 90 lbs. Two-speed action provides rapid approach of ram piston to the work. An appropriate and economical power source for applications in which 20 cu. in. of usable oil is adequate.

Specifications

	4004
Max. operating pressure	10,000 psi
Volume per stroke (first stage)	.305 cu. in.
Volume per stroke (second stage)	.091 cu. in.
Reservoir capacity	24.4 cu. in.
Oil port	3/8" NPT



4000A

2-Speed Hydraulic Hand Pump

This 2-speed pump is ideal for single-acting rams. Developing up to 10,000 psi operating pressure, the pump operates horizontally or vertically in the "head down" position. Fingertip control provides instant release or pumping action. Has a built-in safety overload valve. Ideal for use with OTC single-acting rams, or similar competitors' rams.

Specifications

	4000A
Max. operating pressure	10,000 psi
Volume per stroke Stage 1	.23 cu. in.
Volume per stroke Stage 2	.055 cu. in.
Reservoir capacity	9 cu. in.
Oil port	3/8" NPT



4012A

2-Speed Hydraulic Hand Pump

This 2-speed pump is ideal for single-acting rams. Developing up to 10,000 psi operating pressure, the pump operates horizontally or vertically in the "head down" position. Fingertip control provides instant release or pumping action. Has a built-in safety overload valve. Ideal for use with OTC single-acting rams, or similar competitors' rams.

Specifications

	4012A
Max. operating pressure	10,000 psi
Volume per stroke Stage 1	.79 cu. in.
Volume per stroke Stage 2	.16 cu. in.
Reservoir capacity	43 cu. in.
Oil port	3/8" NPT



Hydraulic Rams for Collision Repair Sets

These premium quality rams are designed for long, trouble-free service. Backed by a two-year warranty, they feature a special piston rod that permits their use with the snap-together components of OTC Stinger's new collision repair sets, or with most similar competitive products.

9104B

4-ton ram with 4" stroke and special piston rod end designed to fit most collision repair set components.

9110B

10-ton ram with 6" stroke and special piston rod end designed to fit most collision repair set components.

Specifications

	9104B	9110B
Min. height	10-3/8"	15"
Max. height	14-3/8"	21"
Spring return	Yes	Yes
Rod end dia.	.874"	1.310"
Max. operating. Pressure	8,950	8,950
Oil cap. (cu. in.)	4.97	13.69
Oil port	1/4" NPT	1/4" NPT



Single-Speed Hydraulic Hand Pumps

These single-speed pumps are ideal for single-acting rams. Developing up to 10,000 psi operating pressure, the pumps operate horizontally or vertically in the "head down" position. Finger tip control provides instant release or pumping action. Has a built-in safety overload valve. Ideal for use with OTC Stinger single-acting rams, or similar competitive rams.

9106B Hand pump only.

9107B Hand pump only.

Specifications

	9106B	9107B
Max. operating pressure	10,000 psi	10,000 psi
Volume per stroke	0.17 cu. in.	0.17 cu. in.
Reservoir capacity	18 cu. in.	30 cu. in.
Oil port	1/4" NPT	1/4" NPT



4026 Air/Hydraulic Power Unit

Features a heavy-duty, one-piece, aluminum body for durability and light weight. A perfect replacement pump for body and frame straightening equipment. Performs in either vertical or horizontal positions. Has a time-tested motor design. All internal moving parts are constructed of metal, not plastic! Unique external relief valve ensures damage-free operation should oil reservoir be overfilled. Internal vent eliminates external oil leakage. Rotary-style pressure release provides superior operator control. Carries OTC's unsurpassed Lifetime Warranty®.

Specifications	4026
Oil delivery	10 cu. in. of oil @ 9,500 psi
Reservoir capacity	39 cu. in. (34 cu. in. usable)
Internal relief setting	10,000 PSI
Air operating pressure	40-120 PSI
Dimensions	16-15/16" L x 6-3/8" H x 5-5/8" W

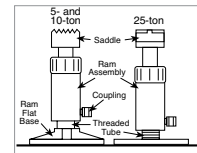
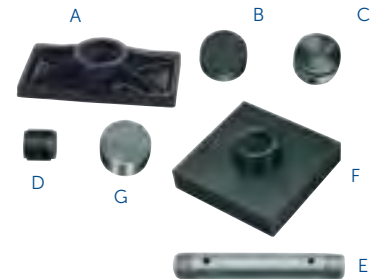

OTC Single Acting Cylinder Rams



		Capacity in Tons	Stroke	Height Collapsed	Height Extended	Oil Capacity (cu. in.)
4100A	5-Ton Single Acting Ram	5	3"	5-11/16"	8-11/16"	3.23
4101A	5-Ton Single Acting Ram	5	5-1/4"	10-7/16"	15-11/16"	5.74
4103A	10-Ton Single Acting Ram	10	2-1/8"	5-9/16"	7-11/16"	4.8
4104A	10-Ton Single Acting Ram	10	6-1/8"	11-1/2"	17-5/8"	13.9
4105A	10-Ton Single Acting Ram	10	10-1/8"	15-1/2"	25-5/8"	22.75
4106A	25-Ton Single Acting Ram	25	6-1/4"	13-3/8"	19-5/8"	32.2
4107A	25-Ton Single Acting Ram	25	14-1/4"	21-3/8"	35-5/8"	73.5
4108A	5-Ton LP Single Acting Ram	5	9/16"	1-5/8"	2-3/16"	.62
4110A	55-Ton Single Acting Ram	55	6-1/4"	11"	17-5/16"	69

Single-Acting Ram Accessories

These versatile attachments let you "harness" OTC hydraulic force and put it to work exactly where it's needed to handle various maintenance tasks. Accessories thread onto the ram's piston rod end or into the ram base.

Use with 10-ton hydraulic rams, Nos. 4103A, 4104A and 4105A.

Item	No.	Description
A	32325	*Ram flat base
B	31772	Serrated saddle
C	24016	Smooth saddle
D	25664	*Threaded tube coupling
E	38909	10" Extension tube

* NOTE: 32325 and 25664 cannot be used on No. 4103 hydraulic ram. Use with 25-ton hydraulic rams, Nos. 4106A and 4107A.

Item	No.	Description
F	25653	Ram flat base
G	31776	Serrated saddle with coupling

55- and 100-Ton Aluminum Rams

Get the strength of a steel ram but about half the weight. Easily carry these single-acting, spring-return rams around the garage, shop, or into the field for on-the-vehicle repairs. They are ideal for truck axle correction, trailer frame straightening, general vehicle maintenance, and heavy-duty lifting.

- 4111** 55-ton aluminum ram. 6-1/8" stroke.
- 4116** 100-ton aluminum ram. 6-1/4" stroke.

208406

Ram base. Attaches directly to bottom of ram by means of two 3/8"-16 screws, included. Serrated base provides extra support and stability. 7" square. For use on 55-ton ram only.

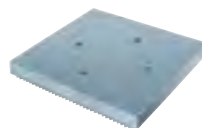

208406



4111



4116

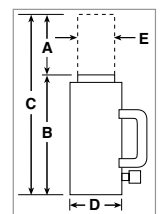

OTC No.	Capacity in Tons	Stroke "A"	Oil Cap. (cu. in.)	Effective Ram Area (sq. in.)	Tons at 10,000 PSI	Spring Return	Height		Piston Protrusion at Collapsed Height	Diameter		Piston Thread (N.P.T.) "F"	Collar Thread (Straight) "G"	Internal Base Thread (N.P.S.M.) "H"	Wt. (lbs./oz.)
							Collapsed "B"	Extended "C"		"D"	"E"				
4111	55	6-1/8"	67.6	11.04	55.2	Yes	10-3/4"	16-7/8"	1/4"	5-1/4"	3-1/8"	None	None	None	25 / 10
4116	100	6-1/4"	129.0	20.62	103.1	Yes	11-3/4"	18"	1/8"	7-3/8"	4-1/8"	None	None	None	64

Spring-Return Hollow Center Hydraulic Rams

Hydraulic Twin Rams have been engineered for increased strength and durability and meets the ASME B30.1 standards. A center-hole design is ideal for push/pull applications while allowing for the extension of cables, screws or wires through the cylinder. Tapped base mounting holes allow for easy installation in fixed applications. Made in USA.

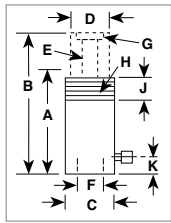

For Use With	Threaded Insert No.	Inside Dia. of Plain Insert *
4131A	28632 3/4"-16 **	49/64"
4132A	28612 1"-8 **	1-3/64"
4139	38904 1-1/4"-7 **	1-19/64"
4140A	34251 1-5/8"-5-1/2 **	2-1/8"

* Plain insert comes standard with rams.
** Internal thread size.

Cylinder Cap. (tons)	Stroke (in.)	OTC No.	A Re-Tracted Height (in.)	B Extended Height (in.)	C Outside Dia. (in.)	D Piston Rod Dia. (in.)	E Center Hole Dia. (in.)	F Inches Between Base Holes	G Insert Thread Size (in.)	H Collar Thread (in.)	J Thread Length (in.)	Oil Cap. (cu. in.)	Int. Press. at Cap. (PSI)	K Base to Inlet Port (in.)	Mounting Holes (in.)	Base Cyl. Eff. Area (sq. in.)	Prod. Wt. (lbs.)
10	2-1/2	4131A	5-5/8	8-1/8	3-3/16	1-1/2	3/4	2-3/8	3/4	1-3/4-12	2	5.53	10,000	1-1/16	2 x 1/4-10	2.21	11.0
20	3	4132A	6	9-7/32	4	2	1	3-1/4	1	None	None	11.76	10,000	1	3/8-16	4.72	18.5
30	2-1/2	4139	6-1/4	8-3/4	4-3/4	3-1/4	1-19/64	3-5/8	2-3/4-12	4-3/4-12	1-1/2	15.85	9,457	1-5/32	7/16-20	6.34	25.6
60	6	4140A	12-3/4	18-3/4	6-1/2	2-3/4	1-5/8	5-1/8	3-12	6-1/4-12	2-1/2	76.38	10,000	1	1/2-13	12.31	86.5

Hollow Center Hydraulic Rams

Center-hole rams are ideal for jobs that require a great deal of force and a relatively short stroke. Compared to the force it develops, the ram is lightweight, compact, and easy to handle, permitting its use in confined quarters. Center-hole feature allows extending jacking screws, cables, puller screws and more to be inserted through the ram.

- Engineered for increased strength and durability and meets the ASME B30.1 standards
- For use with Grip-O-Matic® pullers, push-pullers and shop presses



Hollow Center Hydraulic Ram	Capacity in Tons	Stroke	Height Collapsed	Height Extended	Adapter Plate	Eff. Ram Area (sq. in.)	Oil Capacity (cu. in.)
4120A Single acting ram	17-1/2	2"	5-1/2"	7-1/2"	yes	3-1/2	7.01
4120A-MA Single acting ram	17-1/2	2"	5-1/2"	7-1/2"	-	3-1/2	7.01
4121A Single acting ram	30	2-1/2"	7-3/4"	10-1/4"	yes	6-1/8	15.45
4121A-MA Single acting ram	30	2-1/2"	7-3/4"	10-1/4"	-	6-1/8	15.45
4122A Single acting ram	50	3"	10-1/4"	13-1/4"	yes	9-3/4	29.19
4122A-MA Single acting ram	50	3"	10-1/4"	13-1/4"	-	9-3/4	29.19
4130 Twin double-acting hydraulic ram	100	4-7/8"	15-1/8"	20"	-	19-1/4*	93.8

* Push side only

Ram Accessories



Description	17-1/2 Ton	30-Ton	50-Ton	100-Ton
Speed crank	24814	27198	29595	303785
Speed nut	302482 1"-8 thread	302483 1-1/4"-7 thread	33439 1-5/8"-5-1/2 thread	34136 2-1/2"-8 thread
Adjusting screw	32118 1"-8 thread, 20" long	34758 1-1/4"-7 thread, 24" long	32698 1-5/8"-5-1/2 thread, 30" long	32699 2-1/2"-8 thread, 36" long
Threaded insert	21669 1"-8 thread	21873 1-1/4"-7 thread	22274 1-5/8"-5-1/2 thread	24197 2-1/2"-8 thread
For "A" version rams	573825 1"-8 thread	573834 1-1/4"-7 thread	573810 1-5/8"-5-1/2 thread	24197 2-1/2"-8 thread
Plain-hole insert	21714 1-1/16" dia. hole	21872 1-5/16" dia. hole	22275 1-11/16" dia. hole	24196 2-9/16" dia. hole
Pushing adapter	201923 1"-8 thread, 1/2" dia. shank	34510 1-1/4"-7 thread, 3/4" dia. shank	34755 1-5/8"-5-1/2 thread, 1" dia. shank	-
Pushing adapter	201454 1"-8 thread, 3/4" dia. shank	34511 1-1/4"-7 thread, 1" dia. shank	34756 1-5/8"-5-1/2 thread, 1-1/4" dia. shank	-
Jack screw	24813 1"-8 thread, 7" long	25931 1-1/4"-7 thread, 9" long	-	-
Ram cap	28228 1"-8 thread, 1-1/2" dia.	28229 1-1/4"-7 thread, 1-3/4" dia.	28230 1-5/8"-5-1/2 thread, 2-1/4" dia.	-

"Shorty" Rams, Single-Acting, Spring-Return

Forcing a gravity return ram to retract wastes both time and money. This OTC series of single-acting, spring-return rams eliminates that waiting. With their low collapsed height and the stroke you really need, these rams are ideal for a variety of applications. You can choose from capacities of 10 to 100 tons and strokes from 1-1/2" to 2-7/16", with the largest ram being only 7-3/4" high! Bronze-plated piston rods resist scoring, and each ram can be "dead-ended" at full capacity for maximum safety. Each "Shorty" ram has an angled coupler port (5°) for easy hook-up. So, if you're tired of waiting for your rams to retract, these OTC "Shorty" rams are just the answer to your problems!

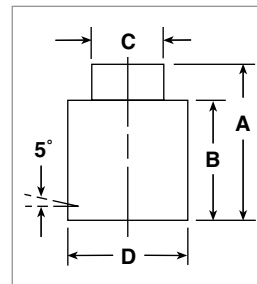

OTC No.	Capacity (tons)	Stroke No.	(A) Extended Height (in.)	(B) Retracted Height (in.)	(C) Piston Rod Dia. (in.)	(D) Outside Dia. (in.)	Cyl. Eff. Area (sq. in.)	Oil Capacity (cu. in.)	Oil Port Return	Type Piston NPTF	Wt. (lbs./oz.)
4141A	10	1-1/2	5	3-1/2	1-1/2	2-3/4	2.24	3.4	3/8"-18	Spring	6
4142A	20	1-3/4	5-1/2	3-7/8	2-5/32	3-9/16	4.39	7.7	3/8"-18	Spring	11 / 3
4143A	30	2-7/16	7-1/16	4-5/8	2-1/2	4	6.49	15.8	3/8"-18	Spring	15
4144A	50	2-3/8	7-3/8	4-7/8	3-1/8	4-7/8	9.86	23.28	3/8"-18	Spring	24
4145A	100	2-1/4	7-3/4	5-1/2	4-3/8	6-1/2	20.58	46.18	3/8"-18	Spring	43



**4175
"Shorty" Ram and Pump Set**

- Shorty rams provide lifting or pushing force in limited working space. Visual centering of load is simplified by a concentric ring pattern on piston top.
- Single-acting, spring-return.
- Two-speed hand pump gives fast piston approach. (See chart below for specifications.)
- Set includes 4143 30-ton, 2-7/16" stroke single-acting spring-return hydraulic ram; 4016 pump; 9767 hose; and 9798 hose half coupler.

OTC Set No.	Capacity (tons)	Ram Stroke	Ram Collapsed Height	Strokes to Obtain Full Ram Stroke	Pump Speed
4175	30	2-7/16"	4-5/8"	55*	Two

* Based on 50% of the stroke being made in low-pressure stage, 50% in high-pressure stage.



**4180
Power Twin Ram and Pump Set**

- Center-hole feature permits extending adjusting screws, cables, puller screws, etc., straight through the ram.
- This spring return unit is compact and lightweight.
- Ideal for jobs having restricted working space.
- Set includes 4120 17-1/2 ton, 2" stroke single-acting hydraulic ram; 4002 pump; 9650 gauge; 24815 tee; 9767 hose; and 9798 hose half coupler.

OTC Set No.	Capacity (tons)	Ram Stroke	Ram Collapsed Height	Strokes to Obtain Full Ram Stroke	Pump Speed
4180	17-1/2	2"	6-7/8"	48	Single



4016

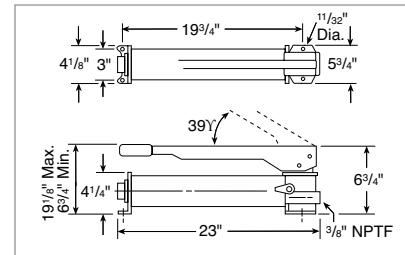

Dualmaster Jr. Two-Stage Hand Pumps

Here's two-stage flexibility at a popular price! These pumps have extra-large reservoirs (125 cu. in. usable oil) and permit use with large hydraulic rams or in multiple small ram applications. Compact and lightweight, Dualmaster Jr. provides maximum flexibility with minimum effort in a portable pump. The 4016 and 4017 deliver... providing high oil volume (2.6 cu. in. per stroke) for rapid ram approach and return. Then they automatically switch at 300 PSI to the high pressure, low volume stage (.16 cu. in. per stroke) for high force applications. Both have a large, non vented reservoir with safety relief valve to prevent over-pressurization of the reservoir. Piston stroke is 3/4", maximum handle effort is 130 lbs. at 10,000 PSI. The 4016 is equipped with a 2-way valve for use with single-acting rams. The 4017 has a 4-way valve for use with double-acting rams. Two versatile hydraulic pumps...dependable power for automotive, heavy-duty truck, agricultural, and construction maintenance needs.

4016

Pump with a 2-way valve for use with single-acting rams. Delivers 2.6 cu. in. of oil per stroke in low pressure stage.

4017

Pump with a 4-way valve for use with double-acting rams. Delivers 2.6 cu. in. of oil per stroke in low pressure stage.

4016 and 4017 Specifications:

- Maximum Operating pressure – 1st- 300 psi / 2nd- 10,000 psi
- Volume per stroke – 1st- 2.6 cu. in. / 2nd- .16 cu. in.
- Piston dia. – 1st- 2" / 2nd- 1/2"
- Piston stroke – 3/4"
- Reservoir capacity – 125 cu. in. usable
- Oil port – 3/8" NPT



Dualmaster® Two-Stage Hand Pumps

Our finest hand-operated power units! These fast acting, two-stage pumps not only handle high force, high pressure requirements up to 10,000 PSI, but deliver extremely high volume at low pressure (7.35 cu. in. per stroke from 0 to 200 PSI) to quickly move the ram piston to and from the work! Pumps have a built-in relief valve, pre set at the factory for 10,000 PSI. Maximum handle effort is 90 lbs. Two basic Dualmaster models are offered: No. 4008 for use with single-acting rams, and No. 4009 for use with double acting rams. For information on pressure gauges, hoses, and other accessories for your Dualmaster, see pages 233 and 234.

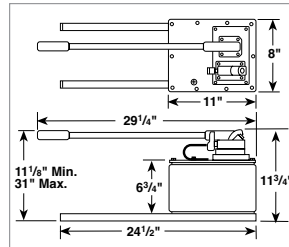

Pump and valving mount on common cover plate; permits use on other than standard OTC reservoirs.



4008

Hydraulic hand pump with No. 9584 2-position, 3-way control valve (for operating single-acting rams), and No. 4006 BL2 2-gallon reservoir with legs.

4009

Hydraulic hand pump with No. 9500 3-position, 4-way control valve (for operating double-acting rams), and No. 4006 BL2 2-gallon reservoir with legs.

Performance Example

Pump No.	Maximum Pressure	Piston Dia.	Piston Stroke	Reservoir Capacity	Oil Port	Job: To fully extend an OTC 4105 ram (has 10-1/8" stroke)	4008/4009 Pump	4016 Pump	4002 Pump
4008 and 4009	1st stage 200 PSI 2nd stage 10,000 PSI	2-1/2" 1/2"	1-1/2"	460 cu. in. usable	3/8" NPTF	5" of ram travel is under no load, 5" is under load	37 strokes	74 strokes	141 strokes

Air / Hydraulic Pump

With shop air as the energy source, these pumps have the power and oil capacity (80 cu. in. usable oil) to drive even the large 55-ton rams. They are ideal all-around power sources for dozens of body, frame, and alignment applications. They can be used with a variety of rams, presses, and hydraulic pullers operating at up to 10,000 PSI. An internal relief valve protects the hydraulic components regardless of hydraulic pressure. In addition, a two-stage release mechanism gives fast or metered ram return while reducing hydraulic shock. In addition to all the features and performance characteristics of the 4020/4025, the 4021 is equipped with a 15 ft. remote control cord. The 4022 is equipped with a 2-gal. reservoir. These pumps require 9 cfm at 100 PSI air pressure at the pump.

- 4020** **Air/hydraulic pump.** Develops 10,000 PSI at 100 PSI air pressure. 3/8" NPTF oil port. 98 cu. in. usable oil capacity in plastic reservoir.
- 4021** **Air/hydraulic pump with a remote control actuator, 15 ft. cord.** Develops 10,000 PSI at 100 PSI air pressure. 3/8" NPTF oil port. 105 cu. in. capacity plastic reservoir.
- 4022** **Air/hydraulic pump with a 2-gallon (442 cu. in.) plastic reservoir.**
- 4025** **Air/hydraulic pump.** Develops 10,000 PSI at 100 PSI air pressure. 3/8" NPTF oil port. 98 cu. in. usable oil capacity in metal reservoir.
- 213896** **Metal reservoir.** 98 cu. in. usable oil capacity. Includes gasket and fasteners.
- 61243** **Replacement plastic reservoir for 4020 pump, 98 cu. in. usable oil capacity.**
- 33853** Replacement gasket for 4020 pump reservoir
- 300871** Repair kit for 4020 pump



4020



4021



2510A

Air/Hydraulic Pump

- 10,000 PSI air/hydraulic pump.
- Internal relief valve.
- Two-stage release mechanism.
- Pump, hold, or release load with pedal control.
- 98 cu. in. useable capacity.
- 3/8 NPT oil port.

538592 Seal kit for 2510A

Performance @ 100 PSI

Hydraulic Pressure* Oil Delivery

0 PSI	59 cu. in./min.
5,000 PSI	30 cu. in./min.
10,000 PSI	4 cu. in./min.

* Oil delivery based on 20 cfm air supply at the pump.



**FOR PRODUCT
VIDEOS VISIT
OTCTOOLS.COM**

Vanguard® Two-Stage, High-Pressure Power Units

Thousands of users have put Vanguard to work in a variety of hydraulic power applications. And the reputation for trouble-free performance this pumping unit has earned is a proven, documented fact, not just a sales claim! Vanguard is a fast-acting, precision-built, two-stage pumping unit consisting of a gear pump for the low-pressure stage and an axial-piston pump for the high-pressure stage, the latter being "supercharged" by the gear pump. Vanguard delivers low volume at high pressure, yet provides high volume at low pressure for fast cylinder piston approach and return. Units feature a 10,000 PSI universal motor, which starts under full load. They are suitable for operation up to 10,000 PSI. Motor is 1-1/8 h.p., 12,000 RPM, (27 amp draw). Rated for intermittent duty.

4062

Vanguard 2-stage hydraulic pump with 2-position/ 3-way valve and 6 ft. remote motor control (115V). 2 gal. of oil supplied.

4064

Vanguard 2-stage hydraulic pump with 3-position/ 4-way valve and 6 ft. remote motor control (115V). 2 gal. of oil supplied.

Speed Comparison Chart

The job — Fully extend a 10-ton ram with a 10-1/8" stroke:

Pump No.	5" travel No load	5" travel Under load	Total Time
4062 Power	1.5 sec.	12 sec.	13.5 sec.
4012A Hand Pump	141 strokes of pump handle		4 to 5 min.*

* Handle effort at max. pressure is 140 lbs.

Performance Oil Delivery

100 PSI	1,000 PSI	5,000 PSI	10,000 PSI
650 cu. in./min.	80 cu. in./min.	70 cu. in./min.	55 cu. in./min.

Pump No.	For use with:	Control Valve	Reservoir	Motor Control	Voltage
4062	Single-acting rams	2-pos., 3-way	2 gal.	Remote 6 ft. cord	1-1/8 H.P., 115V*
4064	Double-acting rams	3-pos., 4-way	2 gal.	Remote 6 ft. cord	50/60Hz, Sgl. Phase

* For 230 volt, please specify.

61217

Electric Pump

- 10,000 PSI max. pressure output
- 3,450 RPM
- 3 PH, 230V/60HZ
- Hose port; 3/8 NPT
- Gauge port; 1/4 NPT
- Useable reservoir 462 sq. in.
- 4-way/3 position solenoid valve
- Valve function; advance, hold, return
- Weight 52.9 lbs.

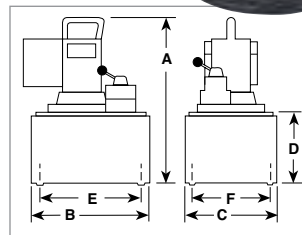

Universal Motor Version



Specifications

A	B	C	D	E	F
18-1/4"	12-1/2"	10-1/2"	7"	10"	8"



207436

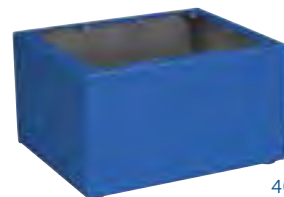

40063BL2

Two-Gallon Reservoir

Increase the oil capacity of your 4020, 4021, or 4025 air/hydraulic pumps with this kit. It gives you a two-gallon reservoir and everything else needed to make those pumps ideal for large, single-acting rams or for multiple ram applications.

207436

2-gallon reservoir kit for 4020, 4021, or 4025 air/hydraulic pumps. Includes reservoir, gasket, top mounting plate, bolts, and fittings. Gives 442 cu. in. usable oil capacity. 11-1/2" x 9-1/2" x 6-1/2".

40063BL2

2-gallon (462 cu. in. usable) "standard" reservoir only for Vanguard® pumps. Size: 12-1/2" x 10-1/2" x 6-1/2" high.

Two-Stage Electric / Hydraulic Pumps

They're called "RamRunners" and that's just what they do...run large single- or double-acting rams for fast frame straightening, wheel alignment, etc. They deliver up to 45 cu. in./min. at max. operating pressure of 10,000 PSI. The 4044 has a 2-position/2-way valve with "advance" and "return" positions and is for use with single-acting rams. The 4046 and 4057 have a 3-position/4-way valve with "advance," "hold," and "return" positions; for use with double-acting or multiple single-acting rams. Nos. 4044 and 4046 are equipped with a 1/2 h.p. single-phase, 60 Hz, 115 volt thermal protected electric motor and are designed to start under load. No. 4057 has a 1-1/2 h.p. electric motor. The RamRunners also feature a 6 ft. remote control cord for "on/off" control. One gallon and two quarts of oil are supplied.

- 4044** RamRunner two-stage hyd. pump with 2-position/2-way manual valve and a 6 ft. remote control cord. Supplied with one gallon and two quarts of oil.
- 4046** RamRunner two-stage hydraulic pump with 3-position/4-way manual valve for double-acting rams, and a 6 ft. remote control cord. Supplied with one gallon and two quarts of oil.
- 4057** RamRunner two-stage hydraulic pump with 3-position/4-way valve for double-acting rams, and a 6 ft. remote control cord. Supplied with one gallon and two quarts of oil.



4044

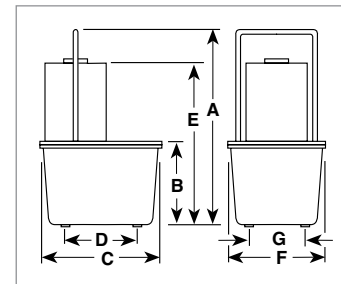

Speed Comparison Chart

The job — Fully extend a 10-ton ram with a 10" stroke:

Pump No.	5" travel No Load	5" travel Under Load	Total Time
4044 / 4046	3 sec.	39 sec.	42 sec.
4057	1.2 sec.	14 sec.	15.2 sec.

Pump No.	Max. Press. Output	RPM	Oil Del.* (cu. in./min. @)			Voltage	Reservoir								
			0 PSI	100 PSI	10,000 PSI		Cap.	Usable	A	B	C	D	E	F	G
4044 / 4046	10,000 psi	3,450	290	240	17	1/2 h.p., 115 volt** 60 Hz, Sgl. Phase	1.9 gal.	295 cu. in.	18-1/2"	7"	11-3/8"	7-1/8"	14-7/8"	9-1/4"	5-1/8"
4057	10,000 psi	3,450	525	490	45	1-1/2 h.p., 115 volt** 60 Hz, Sgl. Phase	1.9 gal.	315 cu. in.	20"	7"	11-3/8"	7-1/8"	14-7/8"	9-1/4"	5-1/8"

* Typical delivery, actual flow will vary with field conditions. ** For 230 volt, please specify.

OTC'S CONTROL VALVES WORK IN A VARIETY OF AUTOMOTIVE AND INDUSTRIAL APPLICATIONS.



9582

9500

Control Valves

- 9582** This is a 2-position/3-way, lever operated, detent positioned valve for use with single-acting rams. It has "advance" and "hold" positions..
- 9500** A 3-position/4-way, lever operated, detent positioned valve for use with double-acting rams. Has "advance," "neutral," and "return" positions. Cylinder ports are blocked in "neutral" and pump flow is directed back to the reservoir.

Vanguard Jr.® Two-Stage, High-Pressure Power Units

Combines compact size and light weight with 2-stage high performance. Choose from several models with electric motors and many options. Designed for operating pressures up to 10,000 PSI. Vanguard Jr. gives you just what you need: 2-stage flexibility with high performance, and a selection of units and options that lets you tailor the pump to your needs. Refer to the performance and speed tables below, and you'll see how these pumps cut down the time needed for almost any job. The 2-stage operation automatically matches pump performance to the job requirements. The low-pressure, high-volume stage provides fast ram approach and return. Then at approximately 200 PSI, the high-pressure, low-volume stage takes over to handle high force requirements. These pumps are ideal for hundreds of hydraulic applications such as clamping, bending, straightening, pressing, forming, testing, pushing, and pulling. Each is equipped with a relief valve factory-set at 10,000 PSI (the maximum operating pressure of the pump). Choose from models with electric (115 or 220 volt) motors and options that include remote hand- and foot-operated motor controls, adjustable pressure regulator, and pressure switch. Vanguard Jr. starts easily under load and has been thoroughly field-tested for high cycle reliability.

- 4031** Vanguard Jr. two-stage hydraulic pump 115V with 2-position/3-way valve and 6 ft. remote motor control. 1 gal. of oil supplied.
- 4031-220V** Vanguard Jr. two-stage hydraulic pump 220V with 2-position/3-way valve and 6 ft. remote motor control. 1 gal. of oil supplied.
- 4033** Vanguard Jr. two-stage hydraulic pump 115V with 3-position/4-way valve and 6 ft. remote motor control. 1 gal. of oil supplied.
- 4033-220V** Vanguard Jr. two-stage hydraulic pump 220V with 3-position/4-way valve and 6 ft. remote motor control. 1 gal. of oil supplied.
- 4036** Vanguard Jr. two-stage hydraulic pump 115V with 3-position/4-way valve and run/off/jog motor control. 2 gal. of oil supplied.
- 4036-220V** Vanguard Jr. two-stage hydraulic pump 220V with 3-position/4-way valve and run/off/jog motor control. 2 gal. of oil supplied.

Speed Comparison Chart

The job — Fully extend a 10-ton ram with a 10-1/8" stroke:

Pump No.	5" travel No Load	5" travel Under Load	Total Time
4031	4 sec.	34 sec.	38 sec.
4002 Hand pump	141 strokes of pump handle		4 to 5 min. *

* Handle effort at max. pressure is 140 lbs.

Universal Motor Version



Universal Motor Version and Large Reservoir Models

These all have a 10,000 PSI pump and universal motor: 1/2 h.p., 12,000 RPM, 115 or 230 volt (specify), 60/50 cycle A.C. single phase. No. 4036 has an extra-large 2-gallon (462 cu. in.) reservoir to permit full stroke of large displacement rams. Also suited for applications where several rams are used.

Pump No.	For use with	Control Valve	Reservoir	Motor Control
4031 / 4031-220V	Single-acting rams	2-position, 3-way	.45 gallon, 104 cu. in.	Remote 6 ft. cord
4033 / 4033-220V	Double-acting rams	3-position, 4-way	.45 gallon, 104 cu. in.	Remote 6 ft. cord
4036 / 4036-220V	Double-acting rams	3-position, 4-way	2 gallon, 462 cu. in.	Run / off / jog

Specifications

Note: Dimensions shown apply to pumps with 104 cu. in. reservoir.

A	B	C	D	E	F
16"	6"	8"	4-3/4"	5-1/8"	7-1/8"

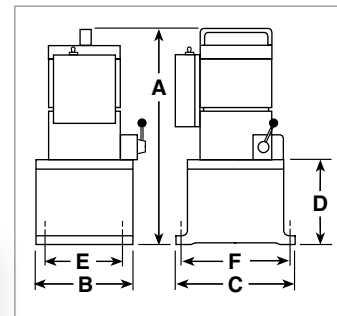

Performance

The low-pressure, high-volume stage provides fast ram approach. When high force is needed, the high-pressure, low-volume stage takes over. The figures below indicate oil delivery of the electric power unit at various pressure levels.

- 170 cu. in./min. at 100 PSI
- 32 cu. in./min. at 1,000 PSI
- 25 cu. in./min. at 5,000 PSI
- 18 cu. in./min. at 10,000 PSI









THOUSANDS OF USER'S HAVE PUT VANGUARD JR. PUMPS TO WORK IN A VARIETY OF HYDRAULIC POWER APPLICATIONS.



Pressure Regulator/Check Valves and Accessories

OTC No.	Description
 9623	Pressure regulator valve. For remote location in a hydraulic system. Adjusts from 1,000 to 10,000 PSI.
 9575	Needle valve for fine metering. Use several for controlling multiple single-acting rams simultaneously, yet independently. 3/8" NPTF ports.
 9596	Load lowering valve. 3/8" NPTF ports, 10,000 PSI max. operating pressure.
 7312	O-ring/oil seal pick. An extremely handy little tool! Makes removal and installation of oil seals and o-rings a snap. Pick has a metal shaft.
 10461	Remote control foot switch, 10 ft. cord. Press for "on," release for "off."
 25017	Remote control hand switch, 10 ft. cord. Press for "on," release for "off." (Replacement rocker switch only, No. 16772)
 9625	Pressure switch. 1/4" NPTF external thread.





Gauges - All gauges have 1/4" NPTF threads

 9650	Pressure and tonnage gauge. Four scales: 0-10,000 PSI, 0-17-1/2-ton, 0-30 ton, and 0-50 ton. 3-1/2" dia. face (Dry)
 9651	Pressure and tonnage gauge. Four scales: 0-10,000 PSI, 0-55 ton, 0-75 ton, and 0-100 ton. 3-1/2" dia. face (Dry).
 9652	Pressure and tonnage gauge. Four scales: 0-10,000 PSI, 0-5 ton, 0-10 ton, and 0-25 ton. 3-1/2" dia. face (Dry).
 9653	Pressure gauge. Two scales: 0-10,000 PSI, and 0-689 BAR. 3 -1/2" dia. face. Use with any OTC pump or ram (Dry)
 9654	Pressure gauge. Two scales: 0-10,000 PSI, and 0-689 BAR. 2 -1/2" dia. face. Use with any OTC pump (Dry).
 9655	Pressure gauge. One scale: 0-6,000 PSI. 3 -1/2" dia. face (Dry).
 9658	Pressure gauge. Two scales: 0-10,000 PSI, and 0-689 BAR. 2 -1/2" dia. face. Gauge is filled with glycerin or silicone to dampen vibration and fluid pulsation. Use with any OTC pump or ram.
 9659	Pressure gauge. Same as 9658 except is liquid filled and has 3-1/2" diameter face.

Adapters and Fittings

 24815	Tee adapter. For installing gauge between pump and hose coupling. Has 1/4" and 3/8" NPTF internal and 3/8" NPTF external.
 25919	Double tee adapter. Permits use of more than one ram in series with one pump. Three 3/8" NPTF ports.
 9617	Manifold block. For use when a multiple-ram system is required. Has six 3/8" NPTF ports.
 9691	"Y" manifold. Useful when connecting two rams to a single line. Three 3/8" NPTF ports.
 10645	45° fitting. Used when mounting gauge at an angle on connection such as 24815. External and internal 1/4" NPTF ends.
 10469	Swivel connector. 3/8" NPTF external, 3/8" NPSM internal.
 10682	Coupling. Both ends 3/8" NPTF internal.
 10474	Street elbow. Internal and external 3/8" NPTF ends.
 10673	Short nipple. 1-1/2" long, 3/8" NPTF external ends.
 13828	Long nipple. 2" long, 3/8" NPTF external ends.
 10647	90° elbow. 3/8" NPTF internal ends.
 13888	Coupling. Ends - 3/8" NPTF internal and 1/2" NPTF external.

Quick Couplers Precision built and designed for high pressure. Permits disconnecting hose without loss of oil.

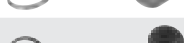
 9795	Complete quick coupler and rubber dust cap. 3/8" NPTF
 9796	Ram half coupler and rubber dust cap. 3/8" NPTF
 9797	Ram half coupler steel dustcap only. 3/8" NPTF
 9798	Hose half coupler only. 3/8" NPTF
 9799	Hose half coupler steel dust cap only. 3/8" NPTF
 9866	Hose or ram rubber half cap. 3/8" NPTF
 9195A	1/4" automotive coupler



Hydraulic Oil

Ensure dependable performance of rams and pumps by using this high-grade, specially prepared oil. Contains foam suppressant additives; high viscosity index.



Hydraulic Hose

Lightweight, rugged hose in lengths to 20 ft. Choose from 1/4" I.D. or 3/8" I.D. high flow hose. All have 3/8" NPTF ends. Operating pressure is 10,000 PSI. Hoses comply with MHI Std. IJ100.

OTC No.	Size	Viscosity	Recommended for use with
9636	1 quart	215 SSU	4000, 4002, 4016, 4017, 4020, 4021
9637	1 gallon	@ 100°F	Vanguard, RamRunner and Stinger pumps

OTC No.	Hose Length	Hose Inside Dia.	Hose Type
9766	3 ft.	1/4"	Braid (2-ply Rating)
9767	6 ft.	1/4"	
9768	8 ft.	1/4"	
9769	10 ft.	1/4"	
9770	12 ft.	1/4"	
9780	6 ft.	3/8"	Nylon Core
9781	10 ft.	High	Synthetic Fiber
9782	20 ft.	Flow	Reinforced *

* Note: This hose is not recommended for use where heat or weld spatter conditions exist.

A

ABS Brake Proportioning Valve Depressor79
A/C and Fuel Line Disconnect Set 92
A/C Clutch Holding Tool91
A/C Clutch Hub Remover/Installer Set91
A/C Clutch Pulley Puller Set91
Accutorq™ Clikker Torque Wrenches107
A/C spring lock coupling tool. 92
Acura Ball Joint Adapter Set 63
Adapter Plates, Engine Stand183
Adjustable Bearing Race
and Seal Driver71, 116
Adjustable Hook Spanner Wrench 49, 106
Adjustable Oil Filter Pliers162
Adjustable Wrenches 108
Air-Assisted High-Lift
Transmission Jack201 – 203
Air Bag Release Tool Kit 90, 95
Air Bag Simulator 90, 96
Air Blow Gun 44
Air Brake Line Release Tools 29, 169
Air Brake Service Kit 169
Air Chuck 189
Air/Hydraulic Bottle Jacks 185, 220
Air/Hydraulic Pump193, 225, 229
Air/Hydraulic Service Jacks 182, 207
Air Lift180, 200
Air Lift & Support Stand179, 202
Air Operated DEF Pump.195
Air Operated Double
Diaphragm DEF Pump195
Air Wedge Lockout Tool 96
Alternator Pulley Service Kit14
Aluminum Racing Jack wall Mount 205
Aluminum Rams 225
Aluminum Service Jacks 205
Aluminum Vice Inserts 109
Angled Crimping Pliers102, 112
Angle-Tip Relay Pliers89, 112
Anti-Static Wrist Strap 89
Audi Strut Nut Socket.67
Automatic Center Punch19, 105
Automatic Transmission
Clutch Spring Compressor 46
Auto Shut-Off DEF Nozzle195
Auxiliary Countershaft Shim Tool.171

Axle Hub Nut Socket 168
Axle Nut Socket 51
Axle Nut Socket Set – FWD. 50
Axle Seal Installer52
Axle Seal Protector53
Axle-Stud Cone Pliers 169

B

Back Buddy™ II 186
Ball Hone Set 54, 79, 118
Ball Joint Application Guide 65
Ball Joint Separator 57 - 66
Ball Joint Sets 63
Ball Peen Hammer 102
Bar-Type Puller/Bearing Separator Set131
Battery Brush 86
Battery Cable Cutter. 86
Battery Carrier 86
Battery Filler. 86
Battery Hydrometer 86
Battery Pliers 86, 112
Battery Terminal Puller 86
Battery Terminal Service Kit. 86
Battery Terminal Wrench 86, 106
Battery Terminal Wrench 86
Bead Breaking Tool 83
Bearing Cup Installer 165, 169
Bearing Cup Remover71, 130
Bearing Driver170
Bearing Driver Set.117
Bearing Puller Set170
Bearing Race and Seal Driver Kit116
Bearing Race and Seal Driver Set71
Bearing Splitter Combo Set132
Bearing Splitters127
Belt Holding Tool13
Belt Tension Gauge14
Bench-Mounted Holding Fixture 49, 203
Blankets, Protective121
Blind Hole Bearing Puller Set131
Blind Hole Puller Set131
Blow Gun. 44, 118
BMW Ball Joint Adapter Set 63
BMW Head Bolt Socket11, 104
Body and Fender Dent Puller97
Bolt Circle Gauge 83

Bolt Grip Set133
Boot Clamp Cutter.32
Boot Clamp Pliers.32
Bosch Nozzle Socket171
Bottle Jacks185, 220
Brake Anchor Pin and Bushing Service Set . . 169
Brake Anchor Pin Pusher. 168
Brake Bleeder Hose79
Brake Bleeders78
Brake Bleeder, Vacuum 40
Brake Bleeding Tools 48
Brake Bleeding Tools, Fluid Evacuation.37
Brake Caliper Pin/Bolt Remover Set76
Brake Drum and Rotor Puller74
Brake Drum Dolly186, 210
Brake Drum Remover. 209
Brake Flaring Tool Kit77
Brake Fluid Tester74
Brake Pad Gauge74
Brake Piston Removal Locking Pliers.75
Brake Pressure Test Kit79
Brake Spring Compressor Tool.76
Brake Spring Locking Pliers76
Brake Spring Pliers and Claw76
Brake Tool Set76
Brass Hammer and Punch Set97
Brass Punch Set97
Broken Bolt Extractor Adapter Set115
Broken Bolt Extractor Tool67, 115
Bronze Center Bushing Service Set.178
Bubble (I.S.O.) Flaring Tool Kit.77
Bucket Pump, Fluid 44
Budd Wheel Sockets167
Bushings Drive Set116
Butane-Power MicroTorch 88

C

Cable Cutters112
Calibration Fluid173
Caliper Hanger Set76
Caliper Pin Remover.76
Cam Gear Holder12
Camshaft Actuator Locking Tool9
Camshaft Retaining Tool.9
Cam Tools2-4
Car Dollies 209

Cart118
 Caster/Camber Adjusting Tool 66
 Caterpillar Fuel Injector Nozzle Puller.....171
 Center and End Bushing Service Set178
 Center Punch19
 C-Frame 64, 52, 83, 115, 162, 216
 Charged Air Cooler Tester..... 164
 Chevy/GMC Ball Joint Adapter Set 64
 Chisel Set.....116
 Chrysler Ball Joint Adapter Set..... 63
 Chrysler Ball Joint Service Kit..... 62
 Chrysler Boot Clamp Pliers 54
 Chrysler Camshaft Alignment Tool Set.....10
 Chrysler Crankshaft Damper
 Remover/Installer Kit10
 Chrysler Fuel Pump
 Module Spanner Wrench..... 30
 Chrysler Harmonic Balancer Holding Tool.....10
 Chrysler Heater Hose Disconnect Tool Set ...47
 Chrysler/Jeep Cam Tool Set.....10
 Chrysler/Mitsubishi Truck
 Ball Joint Adapter Set..... 64
 Chrysler Timing Belt Wrench10
 Chrysler Transmission Dipstick..... 46
 Cigarette Lighter Socket Remover..... 94
 Clamshell Strut Spring Compressor.....61
 Clevis Pin Press..... 169
 Clutch-Adjusting Wrench 164
 Clutch Alignment Tool..... 46
 Clutch Coupling Tool..... 46
 Clutch Rotating Tool 164
 Clutch Service Set.....165
 Clutch Spring Compressor..... 46
 Collision Repair Sets..... 99, 194, 221
 Compression Tester.....5
 Compression Tester - Deep Well Connector...16
 Compression Tester Kit17
 Compressor Bridge Accessory61
 Compressor Drive-Gear Coupling Puller ... 164
 Cone-type Puller 130
 Connecting Rod Guides9
 Control Valves.....231
 Cooling System..... 40
 Cooling System Power Flush Gun118
 Cooling System Pressure Tester..... 39
 Countershaft Bearing Driver.....170

Countershaft Pushing Tool170
 Crank & Cam Seal Service Kit12
 Crankshaft Seal Installer 5, 11
 Cross Peen Hammer 102
 Cummins Diesel Fuel Injector Kit.....171
 Cummins Diesel Fuel
 Injector Remover Kit31, 161
 Cummins Diesel Injector Timing Kit 164
 Cummins Drive-Pulley Tool Set..... 164
 Cummins Engine Barring Tool13, 161
 Cummins Engine Turning Tool..... 13, 64
 Cummins® Fuel Injector Puller Adapter.....171
 Cummins® Injector Puller171
 Cummins® Injector Remover/ Installer.....171
 Cummins Water Pump Pulley Tool 164
 CV Boot Clamp Cutter..... 32, 54
 CV Boot Clamp Installer 54
 CV Boot Clamp Pliers..... 32, 54
 CV Joint Banding Tool and Cutter..... 54
 Cylinder Auto Filler.....78
 Cylinder Leakage Tester Kit.....17
 Cylinder Liner Height Gauge..... 164

D

Davco Diesel Filter Wrenches.....31, 173
 DEF Dispenser Coupler195
 DEF Electric Pump Drum Kit
 with Dispenser Coupler.....195
 DEF Electric Pump Tote Kit
 with Dispenser Coupler.....195
 DEF Nozzle195
 DEF Pump195
 DEF Refractometer..... 31, 198
 Deluxe Radio and Antenna Service Kit... 89, 101
 Dent Puller.....97
 Detroit Diesel Injector Socket.....31, 161
 Diesel Compression Tester..... 160
 Diesel Compression Tester with Adapters ...18
 Diesel Engine Barring Socket161
 Diesel Engine Stand183, 211
 Diesel Filter Wrenches 31
 Diesel Fuel Line Wrench30, 171
 Diesel Fuel Pressure Gauge.....8, 31, 161
 Diesel Particulate Filter Cleaner..... 196, 197
 Differential Bearing Preload Wrench.....52
 Differential Bearing Pullers 52, 130
 Differential Housing Spreader..... 54, 168
 Differential Mounting Adapter 54
 Differential Side Bearing Pullers..... 53, 130

Digital Torque Wrench.....107
 Digital Turbine DEF Flow Meter195
 Disc Brake Pad Spreader75
 Disc Brake Piston Tool.....75
 Disconnect Tools 27, 28
 Disconnect Tool Set..... 92
 Disc Park Brake Caliper Tool Kit.....75
 Distributor Bushing Installer/Reamer.....10
 Dodge Hub Service Set..... 69
 Dodge/Jeep Truck, SUV Ball Joint Adapter Set64
 Dodge Locknut Socket 50, 51, 72
 Door Buzzer Shutoff Tool 89, 96
 Door Handle Spring Retainer 94
 Door Panel & Upholstery Tool Sets 94
 Double Edge Screw Extractors.....19, 105
 Double Flaring Tool Kit77
 DPF Cleaner..... 196, 197
 DPF Handler 198
 DPF Seal Repair Kits197
 DPF Thermal Processing Unit..... 198
 Drain Plug Removal33
 Drain Reservoir 37
 Drilling Guide System.....19, 105
 DriveMaster™ Driveline Lift..... 179, 202
 Dual End Wire Holder 88
 Dualmaster® Two-Stage Hand Pumps..... 229
 Dual/Single Wheel Separator187
 Dual Wheel Bead Breaker 189
 Dual Wheel Dolly 186, 210
 Duramax Water Sensor Wrench.....31, 173

E

Ear-type CV Boot Clamp Pliers 32, 54
 Easy Lever Wheel Dollies..... 186
 E-Clip Tool Set 94
 EGR Valve Puller6
 Electrical Connector Separator Tool..... 88
 Electric DEF Transfer Pump.....195
 Electric Pump 230
 Electronic Ignition Spark Tester16
 End Bushing Adapter Puller Set177
 End Bushing Adapter Puller Set
 for Hendrickson Truck Suspensions.....178
 Engine Load Leveler..... 192, 214
 Engine Preluber Kit.....18, 193
 Engine Slings.....214
 Engine Stand 183, 211, 212

Engine Stand Adapter Plates183, 211
 Engine Support Bars212
 Euro Door Handle Kit 95
 European Radio Tool Set 89, 101
 Euro Radio Removal Tool Kit 89
 Exhaust Back Pressure Gauge 20
 Exhaust Hanger Pliers 20
 External Torx® Plus Socket Set 104
 External Torx® Socket Set 104
 Extraction Dispenser Bottle 46

F

Fan Clutch Holding Tool14
 Filter Crusher 38
 Filter Wrenches 36
 Flange-Type Puller12, 133
 Flange-Type Puller Combination133
 Flange-Type Puller Set 60
 Flare Nut Locking Plier91
 Flare Nut Locking Pliers Set76
 Flexible Magnetic/Claw Pick Up Tool 109
 Flexihead O2 Sensor Wrench 20
 Floor Cranes 191, 192, 213, 214
 Flow Meters 222, 223
 Fluid Bucket Pump 44
 Fluid Evacuation37
 Fluid Evacuation / Brake Bleeding Tools 48
 Fluid Reservoir37
 Flywheel Holder 46
 Flywheel Holding Tool 49
 Folding Floor Cranes214
 Forcing Screw Plug 66
 Ford 4WD Caster/Camber Sleeve Puller 66
 Ford 5-pin Connector Harness
 for Glow Plug Testing 6, 89, 160
 Ford 6.0L Diesel 29
 Ford 6.0L Diesel Fan Clutch Wrench6
 Ford 6.0L Diesel IPR Controller 90
 Ford 6.0L Diesel Service Tool Kit5
 Ford 6.0L Diesel Terminal Release Tool 90
 Ford 6.0L Glow Plug Release Tool 90
 Ford 7.3L Fuel Filter Wrench 29
 Ford Axle Shaft Seal Installers 58, 70
 Ford Ball Joint Adapter Set 63
 Ford Caliper Pin Remover76
 Ford Cam Tools 2, 3, 4
 Ford Caster/Camber Adjusting Wrench 66

Ford Diesel Compression Test Adapter 6, 160
 Ford Diesel Fan Clutch Wrench 6
 Ford Engine Adapters 6
 Ford Fuel Injector Puller Adapter171
 Ford Fuel Line Disconnect Tool Set 48
 Ford Halfshaft Remover/Differential Rotator53
 Ford Heater Hose Disconnect Tool Set47
 Ford High Pressure Oil
 Line Disconnect Tool6, 161
 Ford Injector
 Remover / Installer Kit 30, 161
 Ford Locknut Socket 50, 51, 72
 Ford Lock Pin Remover 59
 Ford Mirror Removal Tool 95
 Ford Oil Line Disconnect Tool 6
 Ford Power Steering Pump Pulley Installer 58
 Ford Radio Removal Tool Kit 90, 101
 Ford Rear Crankshaft Seal Installer 5
 Ford Rear Main Oil Seal Kit 5, 160
 Ford Rear Main Seal Installer 5
 Ford Spark Plug Remover 5
 Ford Supply Tube Removal Tool11
 Ford Torsion Bar Adjustment Tool 66
 Ford Transit Connect Van
 Ball Joint Adapter Set 63
 Ford Transmission Cooler
 Line Disconnect Set 48
 Ford Transmission Fluid Fill Adapter 46
 Ford Truck Ball Joint Adapter Update Kit 65
 Ford Truck Torsion Bar Tool 66
 Ford Vacuum Front Hub Release Tool Set 69
 Ford Valve Spring Compressor Tool16
 Ford Van Ball Joint Adapter 65
 Fork Lift Jacks 181, 208
 Fraction Hex Socket 104
 Freightliner Rear Suspension Tool176
 Front Coil Spring Compressor67
 Front Crank Seal Installer 9
 Front End Service Set 56
 Front Fork & Shock Vice 109
 Front Hub Puller for 4WD Vehicles 69
 Front Suspension Bushing Tool Kit175
 Frost Plug Remover/Installer Set15
 Fuel Injection Application Manual25
 Fuel Injection Cleaner25
 Fuel Injection Kits 22, 24
 Fuel Injector Cleaning Kit 24

Fuel Injector fittings 23, 26
 Fuel Injector Nozzle Puller30, 171
 Fuel Injector Remover Kit31
 Fuel Injector Storage Rack 30, 161
 Fuel Line Disconnect Tool 92
 Fuel Line Disconnect Tool Set 48
 Fuel Line Removal Tool32
 Fuel Line Stopper Kit 26
 Fuel Line Wrench 30
 Fuel Pressure Gauge 26, 31
 Fuel Pressure Gauge, Diesel8
 Fuel Pump Installation Gauge 29
 Fuel Pump Module Spanner Wrench 30
 Fuel Sender Lock Ring Wrench 30
 Fuel Tank Handler 203
 Fuel Tank Lock Ring Wrench 30
 Funnel Spout 36

G

Gear and Pulley Pullers 49, 53, 132
 Giant Adjustable Wrenches 108, 162
 Gland Nut Wrench162
 Gloves, Technician 44
 Glow Plug Bore Reamer 10, 160
 Glow Plug Release Tool6
 Glow Plug Remover 16, 160
 GM Air Brake Line Release Tools 29
 GM Ball Joint Adapter Set 63
 GM Camshaft Actuator Locking Tool9
 GM Camshaft Retaining Tool 9
 GM Cam Tools7, 8
 GM Caster/Camber Adjusting Tool 66
 GM Code Retrieval Key 90
 GM Computer-Controlled Carburetor Tools 30
 GM Connecting Rod Guides9
 GM Cover Alignment Tool11
 GM Crankshaft Balancer Puller Kit8
 GM Diesel Fuel Pressure Gauge8
 GM Door Handle Spring Retainer 94
 GM Duramax Injector Pullers8, 31, 161
 GM Front Crank Seal Installer9
 GM Fuel Line Fitting 26
 GM Fuel Pump Installation Gauge 29
 GM Harmonic Balancer Puller Kit 9
 GM Heater Disconnect Tool 42
 GM Heater Line Quick Connect Separator47

SPECIALTY TOOLS ALPHABETICAL INDEX

GM Hydraulic Clutch Line Disconnect Tool	47	Heavy-Duty Adjustable Slings	192, 214	Honda/Acura Crankshaft and Harmonic Balancer Holder	11
GM Injection Pump Wrench Set	31, 161	Heavy-Duty Bearing Cup Installer	165	Honda/Acura Dampner Holding Tool	11
GM Injector Rail Assembly Remover	9	Heavy-Duty Brake Spring Pliers	170	Honda Ball Joint Adapter Set	63
GM Injector Retaining Clip Replacer	29	Heavy-Duty CV Boot Clamp Installer	54	Honda Locknut Socket	51, 72
GM Injector Seal Installer Adapters	29	Heavy-Duty Drain Plug Pro™	162	Honda/Toyota Truck/Van/SUV Ball Joint Adapter Set	65
GM In-line 4-Cylinder Cam Tool Set	7	Heavy Duty Drain Plug Removal	33	Horseshoe Lock Ring Pliers	111
GM Key Fob Fixture	94	Heavy Duty Extendable Indexing Pry Bar	100, 113	Hose Clamp Pliers	41
GM Locknut Socket	51, 72	Heavy-Duty Floor Cranes	191, 213	Hose Cutter	98, 112
GM Oil Pressure Adapter	11	Heavy-Duty Gear Puller	132	Hose Pinch Off Pliers	16, 32, 112
GM Pan Seal Cutter	9	Heavy-Duty Motor-Rotor® Repair Stand	212	Hose & PVC Cutter	32, 42
GM Pitman Arm Remover	57	Heavy-Duty Oil Filter Crushers	174, 215	Hose & PVC Cutter, Ratcheting	98
GM Power Steering Pump Pulley	59	Heavy-Duty Oil Filter Wrenches	162	Hose Removal Set	33, 101, 114
GM Steering Column Anti-Rotation Pin	94	Heavy-Duty Power Steering Pump Analyzer	168	Hose Removal Tool	42
GM Timing Chain Holding Tool	8	Heavy-Duty Press	216, 217, 218	Hub Application Guide	69
GM Timing Chain Retainer	9	Heavy-Duty Pulley Holder	108, 118	Hubcap Installer	166
GM Torsion Bar Unloading Tool	66	Heavy-Duty Repair Stand	184	Hub Cap Removal Tool	83
GM Transmission Oil Cooler Line Disconnect Tool	47	Heavy-Duty Single Pressure Beam Bearing Splitter Set	132	Hub Grapppler™ Application Guide	69
GM Truck Ball Joint Adapter Set	65	Heavy-Duty Snap Ring Pliers Set	162	Hub Grapppler™ Kit	68
GM Upper Control Arm Knock-Out Tool	67	Heavy-Duty Spindle Adapter	202	Hub Installer	69
GM Water Pump Holding Tool	8	Heavy Duty Tie Rod and Ball Joint Remover	57, 168	Hub Oil Seal Puller	169
GM Water Pump Socket	8	Heavy-Duty Transmission Jack	179	Hub Puller	68
GM W-Body Strut Tool Kit	67	Heavy-Duty Tubing Cutter	32, 48, 77	Hub remover	69, 209
Grease Gun	43	Heavy-Duty U-Joint Puller	165	Hub Resurfacing Kit	70
Grease Gun Holder	44	Heavy Duty Valve Spring Compressor	15	Hydraulic Accessories	233
GripLock Pullers	130	Heavy-Duty Wheel Step	185, 209	Hydraulic Bottle Jack Presses	216
Grip-O-Matic® Pullers	122, 123	Hendrickson Airtex NXT Bushing Adapter Kit	176	Hydraulic Brake Spring Tool	170
Grip Wrench Adapters	97, 129	Hendrickson Bar Pin Adapter Set	176	Hydraulic C-Frame Press	216
Grooved Pulley Strap Wrench	14	Hendrickson Front Suspension Bushing Tool Kit	175, 176	Hydraulic Flow Meters	222, 223
H		Hendrickson Primaax Quick Alignment Socket	176	Hydraulic Grip-O-Matic® Puller	126
Hammer Display	115	Hendrickson PRIMAAAX® Quick Wrench	176	Hydraulic Hand Pump	224
Hammers	102, 115	Hendrickson Rear Suspension Bushing Tool Kit	175	Hydraulic Hoses	234
Hammer & Tire Service Display Rack	115, 187	Hendrickson Suspension Bar Pin End Bushing Adapter Set	178	Hydraulic Hub Grapppler™ Kit	68
Handled Pry Bars	113	Hendrickson Suspension, Hydraulics	177	Hydraulic Hub Kit	68
Hand Operated DEF Pump	195	Hex Socket	104, 171	Hydraulic Oil	234
Hands Free Air Chuck	84	High-Lift Dual Wheel Dolly	186, 210	Hydraulic Puller Sets	135
Harmonic Balancer Installer	13	High-Lift Transmission Jack	179, 201, 203	Hydraulic Push-Puller®	126
Harmonic Balancer Puller Kit	9, 10	High Profile Jack Stand	184, 208	Hydraulic Rams	224, 226, 230, 232
HD Spindle Adapter	179	Hole Punch Kit	97	Hydraulic Rams, Collision Repair Sets	98
Heated Oxygen Sensor Socket	20	Hollow Center Hydraulic Rams	226	Hydraulic Service Jacks	206
Heater Hose Disconnect Tool	42			Hydraulic Sleeve Puller Set	163
Heat Shrink Tubing Set	88			Hydraulic Spreaders	98, 193
Heavy-Duty Adjustable Hook Spanner Wrench	106			Hydraulic Spreaders	221
				Hyundai Ball Joint Adapter Set	64

I

Impact Drivers 106, 116
 Import Truck Ball Joint Adapter Set 64
 Indexing Pry Bar 100, 113
 Injection Pump Wrench Set 31
 Injector Nozzle Puller 30
 Injector Pullers 31
 Injector Rail Assembly Remover 9
 Injector Remover / Installer Kit 30
 Injector Retaining Clip Replacer 29
 Injector Seal Installer Adapters 29
 Injector Sleeve Set 171
 Injector Socket 31
 Injector Tube Remover/Installer 10, 160
 Inner CV Joint Puller 53
 Inner Pinion Bearing Race Installer 53
 Inner Tie Rod Wrenches 58
 Input Shaft Seal Installer 47
 Interchangeable Punch and Chisel Set 116
 Internal/external retaining ring pliers kit 110, 111
 Internal Pulling Attachments 127
 Isuzu Locknut Socket 51

J

Jack Stands 184, 208
 Jeep Ball Joint Service Kit 62
 Jeep Locknut Socket 51
 Jimmy Bars 113, 167

K

Key Fob Fixture 94
 Kia Ball Joint Adapter Set 64
 Kingpin & Brake Anchor Pin Pusher 168

L

Leaf Spring, Pin, and Bushing Service Set 169
 Lexus Ball Joint Adapter Set 64
 Lifting Brackets 192, 214
 Lifting Chains for Floor Cranes 214
 Lifting Systems 180, 200
 Lift Pad Adapters 180, 200
 lights 117
 Line Fluid Stoppers 75
 Live Center Forcing Screw Plug 52, 66
 Load Leveler 192, 212
 Load-Rotor® Positioning Sling 192, 214
 Locking Pliers 106
 Locknut Sockets 51, 71, 72, 166, 167

Locknut Socket Set 50
 Lock-on, Jaw-type Puller Set 132
 Lockout Tool Set 96
 Lock Pin Remover 59
 Long Handled Pry Bar Set 100
 Long Pick and Hook Set 101, 114
 Long-Side Terminal Battery Wrench 86, 106
 Lower Control Arm Prying Tool 66
 Low-Lift Transmission Jack 179, 202
 Low Profile Fluid Receiver 174, 215
 Low profile Jack Stand 208, 184
 Lucas Rear Brake Adjusting Tool 170
 Lug Nut Cap Remover 166, 189
 Lug Nut Cap Remover Locking Pliers 166, 189
 Lug Nut Cap Removers 82

M

MOTORCYCLE / POWERSPORTS
Section: see page 137
Index: see pages 242–243

Mack Fuel Injector Nozzle Tool 171
 Mack Kingpin Socket 168
 MacPherson Strut Spring Hook Compressor 67
 Magnetic Clamp Wire Holder 88
 Magnetic Parts Tray 109
 MAJOR Persuaders Pry Bar Merchandiser 113
 Manual / Pneumatic Pickle Fork Set 57
 Manual Sleeve Puller Set 163
 Master Bolt Grip Set (Grade 8) 12
 Mazda Ball Joint Adapter Set 63, 64
 Mechanical Grip-O-Matic® Pullers 122, 123
 Mechanic's Stethoscope 18, 118
 Mercedes-Benz and BMW Fan Clutch Service Kit 11
 Mercedes-Benz Dashboard Service Tool Kit 90
 Metric Bushing Driver Set 116
 Metric Double Flaring Tool Set with Cutter 77
 Metric Hex Socket Set 104
 Mini Pick and Hook Set 101, 114
 Mini Snap Ring Pliers Set 111
 Mini Tubing Cutter 32, 77
 Mirror and Magnet Set 109
 Mirror Removal Tool 95
 Mitsubishi Ball Joint Adapter Set 63
 MortorQ® Super Bit Set 104
 Motorcycle/ATV Lift 209

Motorcycle/ATV Tire Spoon with Grip 83
 Motorcycle/ATV Wheel Rim Protector Set 83
 Motorcycle Bead Holding Pliers 83
 Motorcycle Brake Caliper Spreader 75
 Motorcycle Tire Bead Alignment Tool 83
 Motorcycle Tire Bead Holding Tools 83
 Multi Purpose Bearing and Puller Set 131
 Multi-purpose Scissors 98, 112
 Multipurpose Strap Wrench 108

N

Noid Lite/IAC Test Kit 25
 Nozlrater Diesel Injector Nozzle Tester 173
 Nozzle-Tester Adapter Set 172
 Nozzle Tester Manifold/Adapter Sets 173

O

Oil Filter Crusher 38, 174, 215
 Oil Filter Pliers 162
 Oil Filter Sockets 34
 Oil Filter Wrenches 35, 162
 Oil Seal and Wear Ring Installer 164
 Oil Seal Pick Set 114
 Outside Dual Wheel Bead Breaker 82, 189
 Overhead Lifts and Hoists chains 192
 Oxygen Sensor Socket 20

P

Pan Seal Cutter 9
 Parasitic Draw Test Switch 86
 Parts Tray 109
 Persuader Pry Bar Merchandiser 113
 Pickle Forks 57
 Pilot Bearing Puller 49, 127, 130, 164
 Pinch Mount Expander Kit 67
 Piston Ring Compressor 15
 Piston Ring Expander Pliers 15
 Pitman Arm Pullers 56, 57
 Pitman Arm Separator 57
 Pliers, Hose Clamp 41
 Power Driver Socket Extensions 105
 Power Steering Bleeder Adapter 59
 Power Steering Pump/Alternator Remover/Installer Tool 59
 Power Steering Pump Analyzer 168
 Power Train Lifts 180, 200, 201
 Preset Torque Wrench Sets 84, 107
 Press Accessories 219
 Presses 216, 217, 218

SPECIALTY TOOLS

ALPHABETICAL INDEX

Pressure Tester, Cooling System 39
 Profile Gauge 97
 Pro Inject-R Kleen Fluid 25
 Propane Enrichment Kit 30
 Protective Blankets 121
 Protector Cups 161
 Pry Bar Head 113
 Pry Bars 100, 193
 Pry Pac 113
 Puller® Leg Extensions 124, 126
 Pullers 122, 123
 Puller Set 133, 134
 Pulley Holder 14
 Pulley Puller 49
 Pulling Hook 52, 70, 128
 Pump Reservoir 230
 Pump, Transfer 44
 Punch and Chisel Set 114
 Punch Set 116
 Push Pin/Body Clip Pliers Set 94
 Push-Pullers® 124
 Push-Puller Set 132

R

R400 Center Bushing Adapter Set 177
 Radio Removal Tool Kit 101
 Ram and Pump Set 193, 228
 Rams 225, 226, 227
 Ratcheting Chain Wrench 108
 Ratcheting Hose & PVC Cutter (Standard) 20, 98, 112
 Ratcheting Jack Stands 184, 208
 Rear Axle Bearing Puller Set 52
 Rear Axle Puller Set 129
 Rear Axle Service Set 52
 Rear Suspension Bushing Tool Kit 175
 Rechargeable Electric Pump 195
 Refilling, Cooling System 40
 Refractometer 31
 Repair Stand 184, 212
 Retaining Ring Pliers 110, 111
 Rolling Head Pry Bar Kit 100, 113
 Rubber Line Clamp Set 28

S

Safety Wire Drill Guide Set, SAE & Metric Set 109
 Safety Wire Twist Pliers 109

S-Cam Air Brake Spring Tool 169
 Scissors 98, 112
 Scraper Set 16
 Screw Extractors 19, 96, 104
 Seal Cutter, Pan 9
 Seal Driver Set 116
 Seal Protector 53
 Seal Puller 47, 53
 Self-Adjusting Clutch Rotating Tool 164
 Sensor Socket Set 20, 36
 Separator Tools 57
 Serpentine Belt Installation Tool 13
 Service Cart 118
 Service Jack 204
 Service Jacks 182, 204–207
 Shaft Protector Set 125
 Shift Rail Seal Installer 47
 Shock Link and Tie Rod Separator 57
 Shop Presses 218
 Short Handled Pry Bar Set 100
 Short Pick and Hook Set 114
 Short Pick, Long Pick and Hook Set 101
 Side Terminal Battery Brush 86
 Side Terminal Battery Wrench 86, 106
 Single Acting Rams 225
 Single-Acting, Spring-Return Rams 227
 Single Pressure Beam Bearing Splitter Set 132
 Single Speed Hydraulic Pump 193
 Slack Adjuster Pullers 169
 Slack Check 169
 Sleeve Installation Plates 164
 Sleeve Puller / Installer Sets 163
 Sleeve Removal Plates 163
 Slide Hammers 100, 128, 162
 Slide Hammer Puller Set 70, 71, 129
 Slide Hammer Rear Axle Puller 52, 71
 Sliding Bead Breaker 82, 189
 Snap Ring Pliers Set 111, 162
 Sockets, Oil Filter 34
 Solder Tool Kit 88
 Spanner Wrench 49, 106
 Spot Weld Cutter Set 96
 Spout Funnel 36, 48
 Spreaders 98
 Spring Compressor, Strut 61

Spring Lock Coupler Disconnect Set 92
 Spring-Return Hollow Center Hydraulic Rams 226
 Sprinter Van Ball Joint Kit 64
 Standard TORX® Socket Set 103
 Steering Column Anti-Rotation Pin 94
 Steering Pivot Pin Remover 59
 Steering Wheel Holder & Pedal Depressor Kit 79, 96
 Steering Wheel Lock Plate Remover 60
 Steering Wheel Puller 60
 Steering Wheel Puller Leg Set 60
 Steering Wheel, Pulley, and Flywheel Puller 14, 60, 133
 Steering Wheel Service Set 60
 Step Plate Adapter Sets 125
 Stethoscope 18
 Storage Rack, Fuel Injector 161
 Straight-Blade Hose Cutter 20
 Stretch Belt Service Set 13
 Strong Box Puller Set 134
 Strut Compressor 61
 Strut, Reduction Gearbox 61
 Strut Rod Nut Socket 67
 StrutTamer 61
 Style Seal Puller 114
 Subaru Ball Joint Adapter Set 64
 Suction Oil Gun 43
 Super Stubby Screwdriver Set 109
 Suspension Bushing Tool 176

T

Tamper-Resistant TORX® 103
 Tamper-Resistant TORX® Plus Socket Set 104
 Technician Gloves 44, 108
 Terminal Release Tool Set 89
 Thread Chaser 106, 193
 Threaded Adapters 125
 Tie Rod Adjusting Tool 58
 Tie Rod and Ball Joint Remover 57, 168
 Tie Rod End Removers 56
 Tie Rod/Pitman Arm Adjusting Set 58
 Tie Rod Sockets 58, 168
 Timing Chain Holding Tool 8
 Timing Chain Retainer 9
 Timing Tensioner Locking Pin Set 14
 Timing Tool 170

Tire Bead Breaker	82, 189	Trim Fastener and Molding Removal Set	94	Upper Arm Alignment Wrenches	66
Tire Bead Locking Pliers	83, 190	Trim Tool Kit	95	Upper Control Arm Bushing Service Set	66
Tire Bead Seater	80, 187	Tripod and Underhoist Stands	209	Upper Control Arm Knock-Out Tool	67
Tire Bead Wedge Pliers	83, 190	Tripod Stand	208	V	
Tire Pressure/Tread Depth Gauge	84	Truck Ball Joint Sets	65	Vacuum Brake Bleeder	40, 78
Tire Service Display	80, 187	Truck Ball Joint Spanner Wrench	65	Vacuum Hose and Fuel Line Removal Tool	16
Tire Service Hammers	82, 189	Truck Brake Spring Pliers	170	Vacuum Hose Removal Tool	32
Tire Spoon Holding Pliers	83, 190	Truck Clutch Adjustment Set	165	Vacuum/Pressure Gauge Kit	18, 26
Tire Spoon Pack	187	Truck Clutch Alignment Shafts	165	Vacuum Pressure Tester	40
Tire Spoon Pack with Hang Rack	80	Truck Clutch & Flywheel Handler	180, 200	Valve Spring Compressor	4, 15
Tire Spoon Rack	80, 187	Truck Front Leaf Spring, Pin, and Bushing Service Set	169	Vanguard® Two-Stage, High-Pressure Power Units	230, 232
Tire Spoons	81, 188	Truck Pinion Sockets	167	Variable Pin Spanner Wrench	11
Tire Valve Installer/Remover Tool	84	Truck Ramps	186, 203	VW Strut Nut Socket	67
Tire Valve Stem Punch Kit	84, 190	Truck Torsion Bar Tool	66	W	
Tool Pack	109	Truck Transmission Bearing Service Set	170	Waterproof Heat Shrink Tubing Set	88
Torque Angle Gauge	107	Truck Wheel Bearing Locknut Sockets	166, 167	Water Pump Puller Remover/Installer	5
Torque Converter Seal Installer	47	Truck Windshield Wiper Puller	95	Water Pump Socket	8
Torque Multiplier	107, 190	Tube Bending Pliers	78	Water Sensor Wrench	31
Torque Wrenches	107, 190	Tubing Bender	32, 78, 91	Wheel Bearing Locknut Socket Set	50, 71
Torque Wrench Sets	84	Tubing Cutter	32, 48, 77, 91	Wheel Dollies	84, 186, 210
Torx® Bit Socket Set	97	Tubular Spanner Wrenches	167	Wheel Loader & Tipper	82, 189
TORX® PlusSocket Set	104	Two-Stage Electric / Hydraulic Pumps	231	Wheel Separator	80
TORX® Socket Set	103	Two-Stage Hand Pumps	229	Wheel Step	185, 209
Toyota A/C Disconnect Tool	92	U		Wheel Stud	54
Toyota Ball Joint Adapter Set	64	U-Joint Puller	165	Wheel Stud Service Kit	168
Toyota Head Bolt Socket	11, 104	U-Joint Removing/Installing Tool	62	Wheel Tipper	82, 189, 190, 210
Toyota Locknut Socket	51, 72	U-Joint Service Adapter	52, 162	Windshield Spray Nozzle Needle	95, 114
TPMS Tire Deflator/Locator	84	Under Axle Jacks	181, 204	Wiper Puller	95
Transfer Pump	44	Underhoist Tripod Stand	208	Wire Connector Tool Set	88
Transfer Tankers	37, 174, 215	Universal Bearing Cup Installer	169	Wire Crimpers	87
Transmission Adapter Kit	49, 203	Universal Belt Tension Gauge	14	Wire Cutters	87
Transmission Adapter Plate Bushings Replacer	47	Universal C-Frame Nut Splitter	106	Wire Drill Guide Set, SAE & Metric Set	109
Transmission Case Holding Fixture	49	Universal Clutch Holder	109	Wire Loom Threading Kit	88
Transmission Cooler Line Disconnect Set	48	Universal Filter Wrench	162	Wire Pulling Tool	88
Transmission Dipstick, Chrysler	46	Universal Hub Puller	69	Wire Strippers	87, 102
Transmission/Engine Oil Pressure Kit	17, 46	Universal Lift Support Clamp	101	Wire Twist Pliers	109
Transmission Fluid Adapters	46	Universal Outside Thread Chaser	106, 193	Work lights	117
Transmission Fluid Fill/Extract Kit	46	Universal Overhead Valve Spring Compressor	16	Wrenches, Oil Filter	35
Transmission Jack	179, 201, 202	Universal Puller for Wet-Type Sleeves	163		
Transmission Jack Adapters	179	Universal Pulley Holder	14		
Transmission Jack Air-Assisted	202	Universal Pulley Holder Locking Pliers	112, 118		
Transmission Jacks Accessories	202	Universal Transmission Adapter	203		
Transmission Mainshaft Bearing and Gear Installer	47				
Transmission Timing Block Sets	170				

MOTORCYCLE / POWERSPORTS

A

Adjustable Primary Locking Bar146
 Alignment Tool, Clutch143
 Aluminum Vice Inserts154
 Angled Crimping Pliers152
 ATV Lift155
 Axle Tool144

B

Ball Hone Set154
 Ball Joint Separator147
 Ball Joint Service Kit147
 Battery Terminal Wrench151
 Bearing and Puller Set145
 Bearing Driver Set148
 Belt Tension Gauge144
 Bit Socket Sets153
 Blind Hole Bearing Puller148
 Blind Hole Puller Set145
 Brake Bleeder150
 Brake Bleeder Hose150
 Brake Caliper Spreader150
 Brake Fluid Tester150
 Brake Piston Removal Locking Pliers150
 Brass Hammer and Punch Set156
 Brass Punch Set156
 Brush, Chain144
 Bushing Driver Set154

C

Cam Chain Tensioner Unloader Tool140
 Cam/Crank Locking Tool139
 C-Frame Nut Splitter157
 C-Frame Press153
 Chain Alignment Tool144
 Chain Breaker and Riveting Tool Kit144
 Chain Brush144
 Chain Master Link Clip Tool144
 Chain Tensioner145
 Clamp Pliers140
 Clutch Alignment Tool143
 Clutch Compressor Tool143
 Clutch Holding Tool143
 Clutch Holding Wrench143
 Clutch Hub and Alternator Puller142
 Clutch Puller143

Clutch Spider Nut Driver144
 Clutch Spider Nut Socket144
 Clutch Spring Compressor Tool143
 Coil Spring Compressor Locking Pliers147
 Compression Tester Kit141
 Cooling System Pressure Tester139
 Crimping Pliers152
 CV Boot Clamp Cutter145
 CV Joint Banding Tool and Cutter145
 Cylinder Leakage Tester Kit141
 Cylinder Snap-Ring Pliers151

D

Digital Torque Wrenches156
 Drain Plug Tool138
 Drive Clutch Holding Fixture143
 Drive Clutch Puller143
 Dual End Wire Holder152

F

Flange Puller146
 Flange Puller Set145
 Flywheel Puller142
 Flywheel Puller Kit142
 Flywheel Socket Set142
 Fork Cap & Compression Valve Socket Set147
 Fork Spring Compressor Kit147
 Front Fork & Shock Vice148
 Fuel Injection Service Kit139
 Fuel Injection Shrader Fitting139
 Fuel Line Disconnects139
 Fuel Pressure Gauge Kit139
 Funnel138

H

Hammer and Punch Set156
 Heat Shrink Tubing Set151
 Heavy Duty Flywheel Puller143
 Heavy Duty Pulley Holder146
 Heavy Duty Valve Spring Compressor139
 Hex Axle Tool144
 Holding Fixture158
 Horseshoe Lock Ring Pliers145
 Hose Clamp Pliers Set138
 Hose Cutter155
 Hose Pinch Off Pliers138
 Hose & PVC Cutter155
 Hose Removal Tool138

Hydraulic Puller Sets136

I

Ignition Switch Housing Alignment Tool151
 Impact Drivers157

L

Lights158
 Line Fluid Stopper Kit150
 Locking Bar146
 Lock Ring Pliers145

M

Magnetic Clamp Wire Holder152
 Magnetic/Claw Pick Up Tool152
 Magnetic Tray155
 Master Cylinder Snap-Ring Pliers151
 Master Torx Bit Socket Sets153
 Mini Pick and Hook Set155
 Mini Snap Ring Pliers Set157
 Mirror and Magnet Set158
 Motorcycle Lift155
 Multi Purpose C-Frame Press153
 Multi-Purpose Scissors152

N

Noid Light139

O

Oil Filter Ring138
 Oil Filter Socket138
 Oil Filter Wrench138
 Outside Thread Chaser158

P

Pick & Hook Set154
 Pick Up Tool152
 Pilot Bearing Puller145
 Piston Ring Compressor Set139
 Piston Ring Expander Pliers138
 Power Driver Socket Extensions153
 Pressure Beam Bearing Splitter Kit145
 Primary Drive Clutch Puller143
 Primary Drive Locking Tool146
 Profile Gauge148
 Pry Bars156
 Pry Bar Set154
 Puller/Bearing Separator148
 Puller/Bearing Separator Set146
 Puller, Grip-O-Matic145

Pullers146
 Pulley and Flywheel Puller146
 Pulley Holder146
 Punch and Chisel Sets157

R

Ratcheting Terminal Crimper155
 Rear Axle Wrench144
 Retaining Ring Pliers145
 Rolling Head Pry Bars156

S

Safety Wire Drill Guide Set150
 Safety Wire Twist Pliers150
 Scissors152
 Scraper Set156
 Screwdriver Set154
 Screw Extractor Set147
 Secondary Drive Clutch Puller143
 Sensor Socket Set139
 Shock Vice148
 Shrader Fitting139
 Snap Ring Pliers151
 Snap Ring Pliers Set155
 Snap Ring Pliers Set157
 Socket Extensions153
 Spanner Wrenches148
 Spark Tester140
 Spoke Tool Set149
 Spoke Torque Wrench Set149
 Spout Funnel138
 Spreader, Brake Caliper150
 Spring Hook150
 Steering Head Bearing Installer147
 Steering Knuckle Separator147
 Steering Neck Bearing Race Remover150
 Steering Stem Bearing Installation Tool148
 Strap Wrench149
 Super Stubby Screwdriver Set154
 Swing Arm Bearing Tool147
 Swing Arm Pivot Bearing Puller147

T

Tappet Block Alignment Set140
 Tappet Oil Filter Screen Plug Tool140
 Terminal Battery Brush151
 Terminal Crimper155

Terminal Release Tool Set152
 Thread Chaser158
 Timing Plug140
 Timing Tensioner Locking Pin Set140
 Tire Bead Alignment Tool149
 Tire Bead Breaking Tool149
 Tire Bead Holding Pliers149
 Tire Bead Holding Tools149
 Tire Pressure/Tread Depth Gauge149
 Tire Spoons149
 Tire Valve Installer/Remover Tool149
 Torque Wrenches156
 Torx Bit Socket Sets153
 Transmission & Steering
 Bearing Puller/Installer Kit142
 Twin Cam Inner Cam Bearing
 Remover/Installer Kit140

U

U-Joint Press147
 Universal C-Frame Nut Splitter157
 Universal Clutch Holder143
 Universal Outside Thread Chaser158
 Universal Pulley Holder146
 Universal Pulley Holder Locking Pliers Set146

V

Vacuum Brake Bleeder150
 Vacuum Hose & Fuel Line Removal Tool138
 Vacuum/Pressure Gauge Kit141
 Vacuum Test Kit141
 Valve Spring Compressor139
 Variable Pin Spanner Wrench157
 Vice Inserts154
 Waterproof Heat Shrink Tubing Set151
 Water Pump Drive & Rotor Puller140

W

Weatherpack Crimper Set155
 Wheel Bearing Removal/Installation Kit148
 Wheel Rim Protector Set149
 Wire Connector Tool Set151
 Wire Holder152
 Wire Pulling Tool151
 Wire Stripper152
 Work Lights158
 Wrenches, Torque156
 Wrist Pin Installer & Remover Tool140

0100 111
 0200 111
 0300 111
 0400 111
 0500 111
 0600 111
 464 130, 146
 465 130, 146
 518 133, 134, 146
 522 49, 53, 132
 525 12, 133, 145
 679 127, 132, 136
 680 127, 136
 714 111, 145
 885 49, 106
 898A 97
 927 124, 132, 134
 938 124, 134
 939 124
 1020 122
 1021 122
 1022 122, 134
 1023 70, 122, 130
 1024 122, 134
 1025 122, 136
 1026 122, 134
 1027 70, 122, 130, 136
 1028 52, 130
 1031 52, 130
 1035 122, 134, 136
 1036 123, 134
 1037 122, 134, 136, 145
 1038 123
 1039 123, 134, 136
 1040 123
 1041 123, 136
 1042 123
 1043 123
 1044 123
 1045 123
 1046 123
 1047 123
 1048 123
 1049 123
 1050 123
 1060 126
 1062 126, 135, 136
 1063 126
 1064 126

1065 126
 1066 126, 135, 136
 1067 126
 1070 126, 135, 136
 1071 126
 1072 126
 1073 126
 1074 126, 135, 136
 1075 126
 1076 126
 1076 135, 136
 1080 126, 135, 136
 1100 124
 1101 124, 134
 1102 124
 1103 124
 1104 124, 126, 134
 1105 124, 126, 135, 136
 1106 124, 126, 136
 1107 124, 126, 136
 1108 124, 126
 1109 124, 126, 136
 1110 124, 126
 1111 124, 126, 135, 136
 1112 126
 1113 126, 135
 1113 136
 1120 111
 1121 127, 132, 134
 1122 70, 127, 130,
 132, 134, 136
 1123 127, 132, 134,
 136, 219
 1124 127, 219
 1125 111
 1126 127, 136, 219
 1127 127, 135, 136
 1128 127, 136
 1130 127, 132, 134,
 135, 136
 1131 111
 1150 127
 1151 127
 1152 127, 134
 1153 127
 1154 127, 135, 136
 1155 100, 128, 129
 1156 100, 128
 1157 128

1158 128
 1165 127
 1166 127, 135, 136
 1170 128, 134, 136
 1171 128
 1172 128
 1173 128
 1174 128
 1176 128, 129, 134, 136
 1177 70, 128, 130, 134
 1178 129
 1179 129
 1180 132
 1181 70, 130
 1182 132
 1183 132
 1184 130
 1200 163
 1201 163
 1202 163
 1203 163
 1205 163
 1219 163
 1221 163
 1222 163
 1223 163
 1225 163
 1227 163
 1230 163
 1230PB 121
 1232 163
 1233 163
 1240 163
 1242 163
 1243 163
 1245 163
 1246 163
 1250 163
 1252 164
 1253 164
 1254 164
 1255 164
 1256 164
 1266 162
 1320 111
 1325 111
 1329 111
 1340 111
 1345 111

1349 111
 1505B 182, 207
 1507B 182, 207
 1510B 182, 207
 1511B 182, 207
 1512 182, 207
 1513B 99, 194, 221
 1515B 99, 194, 221
 1517B 99, 194, 221
 1519B 99, 194, 211
 1520 180, 200
 1521A 202
 1522A 179, 202
 1526A 206
 1532A 205
 1533A 205
 1534A 209
 1536A 206
 1540 181, 208
 1543 186, 210
 1545 155, 209
 1546 205
 1547 205
 1560 111
 1565 111
 1569 111
 1572 209
 1577 37
 1577 174, 215
 1580 209
 1582A 205
 1585A 201
 1590 180, 200
 1591B 179, 202
 1595 180, 200
 1596 205
 1620 134
 1630 118
 1675 134
 1676 134
 1677 134
 1679 136
 1680 136
 1681 136
 1682 136
 1683 136
 1688 135
 1689 135
 1690 135

1723 212
 1725 212
 1726A 212
 1728 201
 1733A 184, 208
 1734A 185, 209
 1735B 184, 212
 1736A 184, 208
 1740 177
 1741 177
 1742 177
 1744 178
 1745 177
 1746 177
 1748 178
 1749 178
 1750 183, 211
 1750A 183, 211
 1757 176
 1758 203
 1763 178
 1764 178
 1767 176
 1768 176
 1769A 186, 210
 1770A 84, 186, 210
 1774B 184, 208
 1778B 184, 208
 1779B 184, 208
 1780 184, 208
 1781B 208
 1783 184, 208
 1784D 184, 208
 1788B 181, 204
 1793A 201
 1794A 201
 1796 184, 206, 208
 1805 214
 1806 192, 214
 1812 192, 212
 1813 191, 213
 1814 191, 213
 1819 191, 213
 1820 191, 213
 1821 38, 174, 215
 1822 192, 212
 1823A 216
 1824A 216

1825 216
 1826 217
 1826A 217
 1833 217
 1834 217
 1845 217
 1846A 217
 1847 217
 1850 217
 1851 217
 1854 218
 1857 218
 1858 218
 1858-1P 218
 1870 203
 1872 217
 1877 38, 174, 215
 1879 219
 1880 219
 1881 219
 1882 219
 1888 219
 1889 219
 1890 219
 1891 219
 1892 219
 1893 219
 1896 38, 174, 215
 1899 219
 1901 166
 1902 50, 71, 166
 1903 166, 167
 1904 166, 167
 1905 166, 167
 1906 166
 1907 166, 167
 1908 166, 167
 1909 166, 167
 1910 166, 167
 1911 166, 167
 1912 166
 1913 166, 167
 1914 166, 167
 1915 166, 167
 1916 166
 1917 166, 167
 1918 166
 1919 166, 167

1920 166
 1921 166, 167
 1922 166, 167
 1923 166, 167
 1924 166, 167
 1925 166, 167
 1926 166
 1927 166, 167
 1928 50, 71, 166, 167
 1929 167
 1930 167
 1931 167
 1932 166, 167
 1933 166, 167
 1934 166
 1935 166, 167
 1936 50, 71, 166
 1937 166, 167
 1938 166, 167
 1939 166
 1940 166
 1941 166
 1944 167
 1945A 167
 1946A 167
 1947A 167
 1948A 167
 1949A 167
 1950M 166
 1951M 166
 1952M 166
 1953M 166
 1954M 166
 1955M 166
 1956M 166
 1957M 166
 1958M 166
 1959M 166
 1960M 166
 1961M 166
 1962M 166
 1975 167
 1976 167
 1977 167
 1978 167
 1979 167
 1980 167
 1981 167

1982M 171
 2002 192, 214
 2004 192, 124
 2015A 209
 2016A 209
 2018A 209
 2036PB 121
 2300 43
 2304 43
 2310 43
 2326 43
 2332 43
 2340 44
 2352 44
 2357 44
 2359 43
 2423 44
 2423 118
 2424 44, 118
 2497 94
 2510A 229
 2549 94
 2550 94
 2551 94
 2860PB 121
 3050E 25
 3054E 25
 3052S 25
 3053S 25
 4000A 224
 4004 224
 4008 136, 299
 4009 229
 4012A 135, 136, 224
 4016 228
 4017 228
 4020 193, 299
 4021 229
 4022 229
 4025 229
 4026 225
 4031 232
 4031-220V 232
 4033 232
 4033-220V 232
 4036 232
 4036-220V 232
 4044 231
 4046 231

4057	231	4261	176	4449	96	4512-7	111, 115
4062	230	4263	176	4450	96	4512-8	111, 115
4064	230	4274	175	4452	96	4512-9	111, 115
4082B	98, 224	4275	175	4460	88	4512-10	111, 115
4083C	98, 244	4277	222	4461	89, 152	4513	111, 162
4085	98	4278	222	4462	88	4513-1	111, 162
4085	193, 221	4285	222	4467	87, 102, 152	4513-2	111, 162
4100A	225	4290	223	4468	87, 102	4513-3	111, 162
4101A	225	4291	223	4470	88	4513-4	111, 162
4103A	225	4292	223	4472	88	4513-5	111, 162
4104A	225	4294	223	4475	14	4513-6	111, 162
4105A	225	4295	54, 168	4477	86, 112	4514	111, 157
4106A	225	4305	192, 214	4480	24, 139	4515	101, 114, 155
4107A	225	4313C	185, 220	4484	87, 155	4517	131, 148
4108A	225	4321C	185, 220	4484-1	87, 155	4518	131, 146
4110A	225	4324	212	4484-2	87, 155	4518-2	131, 146
4111	225	4333	195	4484-3	87, 155	4518-3	131, 146
4116	225	4334	195	4485	96	4520	53, 130
4120A	135, 136, 226	4335	195	4485-1	96	4520-1	53, 130
4120A-MA	226	4336	195	4489	94	4520-2	53, 130
4121A	135, 136, 226	4337	195	4490	109, 155	4520-3	53, 130
4121A-MA	226	4338	195	4491	18, 118	4520-4	53, 130
4122A	135, 136, 226	4339	195	4492	94	4521	42, 138
4122A-MA	226	4340	195	4493	25, 89, 112	4522	16, 32, 42, 138
4130	226	4341	195	4495	28, 92	4523	41
4131A	226	4342	195	4496	41, 138	4524	41
4132A	226	4343	195	4497A	87, 155	4525	41
4139	226	4344	195	4498A	87	4526	132
4140A	226	4383	97	4502	41	4527	132, 145
4141A	227	4401	78	4503	77	4528	46
4142A	227	4403	32, 78	4504	77	4529	59
4143A	227	4404	32, 78	4505	116	4530	59
4144A	227	4406	71, 116	4506	28	4531	13
4145A	227	4407	116	4507	71, 116, 148	4532	131, 145
4175	228	4408	116	4508	47, 53, 70, 114	4533	67
4180	163, 193, 228	4410	116, 154	4508-1	47, 53, 70, 114	4534	131
4200	173	4411	20, 32, 42, 98, 112, 155	4509	20, 32, 42, 98, 112, 155	4535	91
4201	172	4412	20, 32, 42, 98, 112, 155	4509-1	20, 32, 42, 98, 112, 155	4536	91, 131
4202	173	4420	49, 127	4510	16, 32, 41, 112, 138	4537	91
4203	173	4421	49, 127	4512	111, 155	4542	50, 71
4240A	168	4422	49, 127	4512-1	111, 155	4543A	50
4241	168	4437	20, 36, 139	4512-2	111, 155	4543A-1	50
4244	176	4437-8	20, 36, 139	4512-3	111, 155	4543A-2	50
4245	176	4440	35	4512-4	111, 155	4543A-3	50
4247	175	4441	35	4512-5	111, 155	4543A-4	50
4250	175	4448	89, 96	4512-6	111, 155	4543A-5	50
4254	175					4543A-6	50
4255	176					4546	79, 96

4546-1	79, 96	4600-2	114, 157	4619	86	4742	142
4546-2	79, 96	4600-3	114, 157	4620	86	4743	75, 150
4547A	50	4600-4	114, 157	4621	86	4744	144
4547A-29	50	4600-5	114, 157	4622	86	4745	144
4547A-30	50	4600-6	114, 157	4623	54, 145	4746	144
4547A-32	50	4600-7	114, 157	4629	97, 156	4747	149
4547A-34	50	4600-8	114, 157	4631	86	4748	144
4547A-35	50	4600-9	114, 157	4639	86	4749	144
4547A-36	50	4600-10	114, 157	4645	13	4750	84, 149
4547A-38	50	4600-11	114, 157	4650	109, 158	4751	84, 149
4549	94	4600-12	114, 157	4651	96, 104, 147	4754	14, 146
4549-1	94	4600-13	114, 157	4652	14	4758	145
4549-2	94	4600-14	114, 157	4658	95, 114	4769	83, 149
4549-3	94	4600-15	114, 157	4673	20, 36	4770	83, 149
4550	16, 156	4600-16	114, 157	4673-1	20, 36, 139	4771	83, 149
4551	94	4602	97, 156	4673-2	20, 36, 139	4775	83, 149
4554	107	4603	15	4673-3	20, 36, 139	4777	83, 149
4555	35, 162	4603-1	15	4673-4	20, 36, 139	4779	109, 148
4556	35, 162	4603-2	15	4673-5	20, 36, 139	4780	109, 153
4557	35, 162	4603-3	15	4673-6	20, 36, 139	4781	109, 154
4559	57	4604	15	4673-7	20, 36, 139	4782	88, 151
4559-1	57	4604-1	15	4676	95	4783	109, 152
4559-2	57	4604-2	15	4680	95	4784	97, 148
4560	35, 162	4605	116, 157	4681	59	4786	109, 154
4561	35, 162	4605-1	116, 157	4706	101	4790	148
4562	35, 162	4605-2	116, 157	4711	89, 101	4790-1	148
4565	35, 138	4605-3	116, 157	4712	89, 101	4790-2	148
4566	35	4605-4	116, 157	4715	89, 101	4790-3	148
4567	35	4605-5	116, 157	4715-1	89, 101	4790-4	148
4568	35, 138	4605-6	116, 157	4715-2	89, 101	4790-5	148
4572	15, 139	4605-7	116, 157	4715-3	89, 101	4790-6	148
4573	16	4605-8	116, 157	4715-4	89, 101	4790-7	148
4576	106, 157	4605-9	116, 157	4715-5	89, 101	4790-8	148
4579	70, 129	4605-10	116, 157	4715-6	89, 101	4791	106, 148
4581	131, 148	4605-11	116, 157	4715-7	89, 101	4792	106, 148
4582	35	4605-12	116, 157	4715-8	89, 101	4794	109, 150
4584	35	4605-13	116, 157	4715-9	89, 101	4795	109, 150
4589	75	4606	97, 156	4720	54	4796	150
4590	76	4607	106, 116, 157	4721	32, 42, 54, 145	4797	148
4591	76	4608	106, 116, 157	4722	54	4799	75, 150
4592	170	4611	86	4723	32, 41, 54, 140	4800	142
4592-1	170	4612	86	4724	54	4801	109, 143
4597	41	4613	86, 112	4731A	11	4802	112, 118, 146
4598-DOT3	74, 150	4614	86, 106, 151	4732	11	4803	118, 146
4598-DOT4	74, 150	4615	86, 106	4738	144	4804	108
4599	79, 150	4616	86, 106, 151	4739	144	4804	118, 146
4600	114, 157	4617	86, 151	4740	150	4809	79
4600-1	114, 157	4618	86	4741	149	4813	88, 151

4814	88, 151	4974	143	5060	31, 161	5292	181, 204
4818	98, 112, 152	4975	143	5062	171	5295	180, 200
4822	88, 151	4978	143	5063	170	5300	206
4838	15, 139	4979	143	5064	170	5302	206
4839	15, 138	4980	143	5065	170	5303	206
4840	15, 139	4984	143	5066	170	5372	184, 206, 208
4842	15, 139	4985	143	5068	58, 168	5373	184, 208
4844	139	4986	143	5070	165	5550	117, 158
4845	140	4987	144	5071	164	5551	117, 158
4846	140	4988	144	5072	170	5552	117, 158
4847A	140	4989	144	5077A	37, 174, 215	5603	16
4848	36, 48, 138	4990	143	5078	179, 201	5604	141
4849	140	4991	143	5079	168	5605	17
4850	142	4992	143	5080A	169	5606	17
4851	140	4995	147	5081	169	5607	5
4852	146	5015A	180, 200	5082	190, 210	5608	5
4856	146	5017A	186, 210	5085	169	5609	17, 141
4858	143	5018A	180, 200	5086	99, 194, 221	5610	17, 46
4860	142	5019A	179, 202	5089	29, 169	5613	18, 26, 141
4864-1	142	5020	18, 160	5090	186, 209	5630	26
4864-2	142	5021	18, 160	5091	179, 202	5693	80, 187
4864-3	142	5022	164	5093B	181, 204	5700A	80, 187
4864-4	142	5024	171	5095A	84, 184, 210	5700-DISPLAY	80,
4864-5	142	5025	31, 198	5096A	84, 186, 210		115, 187
4864-6	142	5028	128, 162	5097	37, 174, 215	5702	80, 187
4866	140	5029	165	5100	84, 210	5713	80, 187
4870	151	5030	165	5105B	84, 186, 210	5715	80, 187
4875	139	5035	165	5130	179, 202	5716	81, 188
4876	139	5038	169	5180	153, 216	5716G	81, 188
4878	151	5039	164	5190A	165	5720	81, 188
4880	144	5040	171	5191	165	5724	81, 188
4882	144	5042	171	5192	165	5726	83, 149
4884	147	5043	165	5200	204	5727	82, 189
4886	147	5044	164, 165	5202A	205	5728	82, 189
4888	142	5045	165	5203A	205	5729	82, 189
4889	147	5046	165	5213A	185, 220	5730	83, 149
4891	147	5047	82, 166, 189	5213TA	185	5731	83, 190
4892	147	5047LP	82, 166, 189	5213TA	220	5732	83, 190
4896	138	5048	164	5214	181, 208	5733	83, 190
4898	138	5049	145, 164	5221A	185, 220	5734-18	81, 149, 188
4948	140	5051	170	5237	201	5734-18G	81, 149, 188
4964	147	5052	169	5267	180, 200	5735-18	81, 188
4965	147	5053	168	5268	186, 203	5735-18G	81, 188
4966	147	5054	169	5269	186, 203	5735-35	81, 188
4968	147	5055	169	5280	197	5735-35G	81, 188
4970	143	5056	169	5281	198	5735-42	81, 188
4971	143	5057	67, 169	5285	180, 200	5735-42K	81, 188
4972	143	5059	166	5286	196	5735-PACK	80, 187

5736-18 81, 188
 5736-18G 81, 188
 5736-24 81, 188
 5736-24G 81, 188
 5736-30 81, 188
 5737-30 81, 188
 5739-24 81, 188
 5739-30 81, 188
 5744 84
 5745 84, 189
 5747 84, 190
 5747-2 84, 190
 5747-3 84, 190
 5750 82, 189
 5752 82, 189
 5758 83
 5758-1 83
 5759 83
 5776 84, 107
 5776-1 84, 107
 5776-2 84, 107
 5776-3 84, 107
 5776-4 84, 107
 5776-5 84, 107
 5789ID-520 82,
 115, 189
 5789ID-1032 82,
 115, 189
 5789-PACK 80, 187
 5790ID-616 115
 5790ID-624 115
 5790ID-630 115
 5790ID-812 115
 5790ID-816 115
 5790ID-824 115
 5790ID-830 115
 5790ID-1030 115
 5790ID-1230 115
 5790ID-1430 115
 5790-PACK 115
 5791ID-312 102, 115
 5791ID-412 102, 115
 5791ID-416 102, 115
 5792ID-216 102, 115
 5792ID-316 102, 115
 5793ID-2414 102, 115
 5793ID-3214 102, 115
 5801SGLV-L 44,
 100, 108

5801SGLV-XL 44, 108
 5900A-PLUS 97,
 105, 153
 5905 104
 5905-8 104
 5905-10 104
 5905-15 104
 5905-20 104
 5905-25 104
 5905-27 104
 5905-30 104
 5905-40 104
 5905-45 104
 5905-50 104
 5905-55 104
 5906 103
 5908 103
 5911A 33, 138
 5912 87, 102, 112, 152
 5918 103
 5919 103
 5920 103
 5921 103
 5922 103
 5923 103
 5924 103
 5925 103
 5926 103
 5927 103
 5928 103
 5929 103
 5930 103
 5931 104
 5931-6 104
 5931-7 104
 5931-8 104
 5931-10 104
 5931-11 104
 5931-12 104
 5931-14 104
 5931-16 104
 5933 104, 153
 5933-0 104, 153
 5933-1 104, 153
 5933-2 104, 153
 5933-3 104, 153
 5933-4 104, 153
 5934 103
 5935 103

5936 103
 5937 103
 5938 103
 5939 103
 5940 11, 104
 5942 104
 5942-4 104
 5942-5 104
 5942-6 104
 5942-8 104
 5942-10 104
 5942-12 104
 5942-14 104
 5942-16 104
 5943 105, 153
 5943-1 105, 153
 5943-2 105, 153
 5943-3 105, 153
 5945 90, 95
 5950A 87, 102, 152
 5950K 87, 102, 152
 5950S 87, 102, 152
 5953 88, 152
 5955 88, 152
 5961 33
 5961HD 33, 162
 6005A 16, 160
 6006 51, 72
 6007 66
 6009 3
 6020 3
 6022 11, 104
 6023 25
 6024 3
 6024 4
 6043 40, 118
 6046 42
 6060A 8
 6065 58, 168
 6067 30, 161
 6068 6
 6069 31, 161
 6073 92
 6075 10
 6076 6, 160
 6080 171
 6084 58
 6087 31, 161

6088 6, 89, 160
 6093 75
 6100 103, 153
 6101 103, 153
 6102 103, 153
 6103 103, 153
 6104 103, 153
 6105 103, 153
 6106 103, 153
 6107 103, 153
 6108 103, 153
 6109 103, 153
 6110 103, 153
 6111 103, 153
 6112 103, 153
 6145 103
 6150 104, 153
 6151 103, 104, 153
 6152 103, 104, 153
 6153 103, 104, 153
 6154 103, 104, 153
 6155 103, 104, 153
 6156 103, 104, 153
 6157 103, 104, 153
 6160 104
 6161 104
 6162 104
 6163 104
 6164 104
 6165 104
 6166 104
 6167 104
 6170 104, 153
 6171 104, 153
 6172 104, 153
 6173 104, 153
 6174 104, 153
 6175 104, 153
 6176 104, 153
 6177 104, 153
 6180 104, 153
 6181 103, 104, 153
 6182 103, 104, 153
 6183 103, 104, 153
 6184 103, 104, 153
 6185 103, 104, 153
 6186 103, 104, 153
 6187 103, 104, 153

6188 103, 104, 153
 6191 103, 104, 153
 6192 103
 6193 103
 6198 103
 6260 25
 6266 25
 6274 58
 6275 58
 6284 10
 6290A 69
 6293 10
 6295 56
 6296 56
 6297 56, 66
 6299 57
 6466 3
 6467 3
 6468 3
 6469 3
 6470 3
 6471 3
 6472 3
 6473 3
 6474 3
 6475 3
 6476 3
 6477 3
 6478 3
 6479 3
 6480 3
 6481 3
 6482 3
 6483 3
 6484 3
 6485 3
 6486A 4
 6487 4
 6488 4
 6489 2
 6492 18, 193
 6494 61
 6495 10
 6496 56
 6497 56
 6498 4
 6500 20
 6501 128

6502 77
 6503 77
 6504 77
 6505 13
 6506 77
 6508 27
 6508 48, 92
 6509 28, 92
 6511 28, 48
 6512 32, 48, 77, 91
 6514 32, 48, 77, 91
 6515 32, 78, 91
 6516 76
 6517 28, 48, 92
 6529 62
 6529-1 63
 6529-2 63
 6529-3 63
 6529-4 63
 6529-5 63
 6529-6 63
 6529-10 64
 6529MAN-17 65
 6530 62
 6531 57
 6532 57
 6533 57
 6534 57
 6535 57
 6535 66
 6539 62
 6539-1 64
 6539-2 64
 6539-3 64
 6539-4 65
 6539-10 65
 6540 52
 6541 52, 70, 128
 6542 71, 130
 6550 22
 6550MAN-13 25
 6550PRO 22
 6553 9
 6554 28
 6556 30
 6559 62
 6574 69
 6574-1 69

6575 68
 6575-1 68
 6575-2 68
 6575-2C 68
 6575-3 68
 6575-4 68
 6575H 68
 6575MAN-09 69
 6576 69
 6576S 69
 6577 69
 6578 67, 70
 6579 48
 6582 61
 6583 61
 6587 61
 6589 16, 140
 6591-1 61
 6593 48
 6594 6, 29, 36
 6595 6, 36, 161
 6596 74
 6599 30
 6601 50, 72
 6602 52
 6603A 28
 6604 46
 6611 48
 6612 51, 72
 6613 11, 157
 6614 132
 6616 8
 6617 14
 6627 97, 129
 6637 61
 6637-ST 61
 6642 95, 148
 6644 94
 6646 64
 6647 64
 6648 63
 6649 64
 6651 64
 6652 64
 6653 63
 6660 6, 160
 6667 10
 6668 9

6673 14, 144
 6675 7
 6676 95
 6677 9
 6678 12
 6679 12
 6680 4
 6681 4
 6682 4
 6683 4
 6684 4
 6685 7
 6686 8
 6687 8
 6688 8
 6689 10
 6690 2
 6690-1 2
 6691 9
 6694 52
 6695 58, 70
 6697 58, 70
 6698 58, 70
 6702 47
 6703 26, 36, 48,
 75, 92, 150
 6703-1 26, 36, 48,
 75, 92, 150
 6703-2 26, 36, 48,
 75, 92, 150
 6703-3 26, 36, 48,
 75, 92, 150
 6706 9
 6707 29
 6708 29
 6710 29
 6711 90
 6712 53
 6713 53
 6714 47
 6715 47
 6716 47
 6719-1 106
 6720 76
 6720-1 76
 6720-2 76
 6720-3 76
 6720-4 76
 6720-4 91
 6722 76

6723 53
 6724 47
 6730 64
 6731 65
 6732 65
 6733 65
 6734 63
 6735 64
 6736 64
 6742 11
 6744 8
 6745 9
 6746 8
 6749 161
 6752 30, 161
 6753 30, 161
 6754 8, 31, 161
 6758 9
 6760 29
 6763 29
 6764 29, 90
 6765 29
 6766 29, 90
 6768 6, 29, 90
 6770 5, 29
 6778 8, 31, 161
 6779 8, 31, 161
 6784 34
 6785 95
 6786 34
 6788 9
 6792 46
 6792-EDB 46
 6792-TFA 46
 6796 51, 72
 6900 5
 6901 34, 138
 6903 34
 6904 34
 6905 34, 138
 6906 34, 138
 6908 34
 6914 31, 36, 173
 6915 31, 36, 173
 6916 31, 173
 6918 5
 6921 51
 6921 72

6928 51, 72
 6930 12, 60, 133, 146
 6931 20
 6935 52, 162
 6939 67, 115, 147
 6939-1 67, 115
 6945 86
 6968 108
 6969 108
 6974 6
 6975 40
 6976 40
 6977 39
 6978 40, 141
 6979 74
 6980 74
 6981 131, 145
 6982ACP 19, 105
 6982DEX 19, 105
 6982DEX-1 19, 105
 6982DEX-2 19, 105
 6982DEX-3 19, 105
 6982DGS 19, 105
 6982DGS-1 19, 105
 6982DGS-2 19, 105
 6982DGS-3 19, 105
 6985 11
 7000A 25
 7000A-1 25
 7005 59
 7011 54, 79, 118, 154
 7011-1 54, 79, 118, 154
 7011-2 54, 79, 118, 154
 7011-3 54, 79, 118, 154
 7011-4 54, 79, 118, 154
 7011-5 54, 79, 118, 154
 7011-6 54, 79, 118, 154
 7011-8 54, 79, 118, 154
 7011-10 54, 79, 118, 154
 7011-12 54, 79, 118, 154
 7011-14 54, 79, 118, 154
 7020 49, 158, 203
 7023 58
 7024 46
 7028 164, 165
 7034 75
 7040-1 49
 7045B 67

7053K 110
 7057 165
 7062A 36, 162
 7068 66
 7069A 170
 7070A 170
 7071 54, 168
 7072A 165
 7073A 165
 7074A 165
 7075 170
 7077 169
 7080 65
 7090A 51, 72
 7095 58
 7096 58
 7097 58
 7100 192, 214
 7103 114
 7106 164
 7108 170
 7109 170
 7117 171
 7118 49, 203
 7119 164
 7120 164
 7120A 164
 7120B 164
 7121 171
 7122R 59
 7123K 110
 7125K 110
 7135A 69
 7136 71, 130
 7140 53
 7148 30
 7157 51, 72
 7158 51, 72
 7161 13, 164
 7162 100, 113
 7163 100, 113, 156
 7163 156
 7164 100, 113
 7165 113, 156
 7166 113, 167
 7167 113, 167
 7168 113, 167
 7171 113

7172 100, 113
 7173 100, 113
 7174 100, 113
 7175 100, 113
 7176 100, 113
 7177 100, 113
 7179 100, 113
 7180 169
 7185 59
 7187 25
 7188 25
 7189 20
 7196 12
 7206 108, 149
 7208A 69, 70, 130
 7209 59
 7211 26, 139
 7215 20
 7217 51, 72, 167
 7218 51, 72
 7219 11
 7220 59
 7221 46
 7222 10, 160
 7223 10, 160
 7238 92
 7239 92
 7242 92
 7245 60
 7248 52, 62, 83,
 115, 162
 7249 62
 7269 50, 72
 7270A 51, 72
 7294 67
 7295 111
 7299 76
 7300 110, 162
 7301 110, 162
 7302 76
 7302-1 76
 7302-2 76
 7307 106
 7308 106
 7309 106
 7310A 56, 134
 7311A 56, 134
 7312 114, 233
 7313 111, 145

7314A 56
 7315A 56
 7317A 75
 7318 49, 130
 7319 49, 130
 7337 28
 7342 26
 7350 117
 7361 28, 139
 7362 59
 7363 28
 7367 107, 190
 7368 107, 190
 7372 52, 71, 129, 134
 7374 52, 71, 129
 7375 107, 156
 7377 107, 156
 7378 107, 190
 7379 107, 190
 7380-E150 107, 156
 7392 49, 53,
 132, 134, 136
 7393 49, 53, 70,
 130, 132
 7394 69
 7400 108
 7401 108
 7402 106, 158, 193
 7403 14, 60,
 133, 134, 146
 7410 111
 7412K 111
 7419 3, 14, 140
 7420 113, 167
 7424 13
 7425 13
 7433 26
 7445 46
 7446 46
 7447 11
 7448A 22
 7453A 171
 7454 30
 7455 171
 7458 171
 7460 30, 171
 7462 170
 7463 162
 7470 164

7471A 13, 161
 7480 165
 7481 11
 7482 6
 7483A 5
 7484 58
 7486 79
 7488A 79
 7490 165
 7491C 67
 7494A 52
 7495A 52, 129
 7496A 52, 129
 7497A 52, 129
 7500 58
 7501 58
 7502 53
 7503 56
 7503HD 57, 168
 7507 53
 7508 53
 7509 53
 7534 66
 7537 66
 7544 67
 7575 90, 101
 7588A 66
 7595A 58
 7601 25
 7602 25, 139
 7608 25
 7612 51, 72
 7628 26
 7629 26
 7631 26
 7640 108, 162
 7641 108, 162
 7645 86
 7646A 46
 7649A 24
 7654A 13
 7661 76
 7666 23, 24
 7667 30
 7677 20
 7687A 113
 7698 51, 72
 7703 100, 128

7704 65
 7707 67
 7737 89, 152
 7738 89, 152
 7739 90
 7740 89, 152
 7741 89, 152
 7742 89, 152
 7743 89, 152
 7744 89
 7771A 58
 7786 5
 7790 12, 60, 133, 145
 7792 52, 129
 7793 12, 133
 7795 51, 72, 166
 7796 51, 72, 166
 7807 20
 7815 60
 7816 66
 7822A 66
 7825 65
 7826 66
 7828 25
 7829 66
 7830A 59
 7832 66
 7832-1 66
 7832-2 66
 7834 5
 7835 5, 160
 7840 66
 7853 79
 7889 59
 7894 64
 7901 69
 7910 47
 7911 8
 7912 8
 7917 52, 66
 7918 63
 7919 65
 7920 65
 7924A 69
 7927A 60
 7928 4, 16
 7929A 60
 7932 69

7937 27, 47
 7941 51, 72
 7947 129
 7948 71, 129
 7956 90, 96
 7984 60
 7991 39, 139
 7991-2 39
 7991-3 39
 7991-4 39
 7991-7 39
 7996 63
 7997 10
 7998 30
 7999 10
 8000 125
 8001 125
 8002 125
 8003 125
 8004 125
 8005 125
 8005 136
 8006 125, 136
 8007 125, 136
 8008 125
 8009 125
 8010 125, 136
 8011 125
 8012 125, 136
 8013 125, 136
 8014 125
 8015 125, 136
 8016 125
 8017 125, 136
 8018 125, 136
 8019 125, 136
 8020 125, 135, 136
 8021 125, 136
 8022 125
 8023 125, 135, 136
 8024 125, 136
 8025 125, 136
 8027 125, 136
 8028 125, 135, 136
 8029 125, 135, 136
 8030 125
 8031 62
 8032A 63

8033	63
8034	64
8035	125, 134
8036	125, 135, 136
8037	125, 134
8038	125, 134, 135, 136
8039	125, 134
8040	125, 134
8041	125, 134
8042	125
8043	125, 134
8044	125, 134, 136
8050	125
8051	125
8052	125
8053	125
8054	125
8055	125
8056	125, 136
8057	125
8058	125
8059	125
8060	125
8061	125
8062	125
8063	125
8064	125
8065	125
8066	125
8067	125
8068	125
8069	125
8070	125
8071	125
8072	125
8073	125
8074	125
8075	125, 134, 136, 219
8076	125, 136, 219
8100	37, 48, 54, 78
8101	37, 48, 54, 78
8101-SET	78
8104A	40, 78, 150
8104A-SET	40, 78
8106	78
8111	125
8112	125
8113	125
8114	125
8115	125
8116	125
8117	125
8121	125
8122	125
8123	125
8124	125
8125	125
8126	125
8131	125
8132	125
8133	125
8134	125
8135	125
8136	125
8137	125
8141	125
8142	125
8143	125
8144	125
8145	125
8146	125
8147	125
8148	125
8149	57
8150	57
8200A	95
8203L	100, 113, 154, 193
8203S	100, 113, 154, 193
8208	100, 113, 154, 193
8212	100, 113, 154, 193
8218	100, 113, 154, 193
8224	100, 113, 154, 193
8236	100, 113, 154, 193
8248	100, 113, 154, 193
8260	33, 42, 101, 114, 138
8260M	101, 114
8262	114, 154
8263	101, 114, 154
8342	70
9101B	98, 221
9102	98, 221
9104B	98, 224
9106B	224
9107B	193, 224
9110B	98, 193, 224
9195A	233
9302	185, 220
9303	185, 220
9305	185, 220
9308	185, 220
9312	185, 220
9314	185, 220
9320	185, 220
9322	185, 220
9330	185, 220
9350	185, 220
9500	231
9575	233
9582	231
9596	233
9617	233
9623	233
9625	233
9636	234
9637	234
9650	135, 136, 233
9651	233
9652	233
9653	233
9654	233
9655	233
9658	233
9659	233
9691	233
9766	234
9767	135, 136, 234
9768	234
9769	234
9770	234
9780	177, 234
9781	234
9782	234
9795	233
9796	233
9797	233
9798	135, 136, 233
9799	233
9814	167
9850	166
9851	167
9852	167
9866	233
9900A	113
9901A	113
10012	117
10020	117
10088	163
10215	136
10221	163
10461	233
10469	233
10474	233
10586	163
10645	233
10647	233
10673	233
10682	233
10854	117
10855	117
11466	163
11565	173
12001	117
13828	233
13888	233
15702	110
17169	173
18886	134
21332	219
21669	227
21714	163, 227
21872	227
21873	227
22185	128
22205-PK5	163
22274	227
22275	227
23617	172, 173
23621	172, 173
23622	172, 173
23623	172
23624	172
23626	172
23692	172
23693	172, 173
24016	225
24196	227
24197	227
24544	129
24545	129
24813	227

24814	126, 135, 136, 227
24815	135, 136, 233
24824	163
24829	136
24832	127, 136
24833	127, 136
25017	233
25653	225
25664	225
25919	233
25931	227
27198	126, 135, 136, 227
27241	129
27315	52, 70, 128, 129
27315	129
27487	117
27488	117
27489	117
27490	117
27491	117
27492	117
27493	117
27494	117
27495	117
27496	117
27497	117
27498	117
27499	117
27500	117
27501	117
27502	117
27503	117
27504	117
27505	117
27506	117
27507	117
27508	117
27509	117
27510	117
27511	117
27512	117
27513	117
27514	117
27515	117
27516	117
27517	117
27518	117
27519	117
27520	117
27521	117
27522	117
27523	117
27524	117
27525	117
27526	117
27527	117
27528	117
27529	117
27530	117
27531	117
27532	117
27533	117
27534	117
27535	117
27536	117
27537	117
27538	117
27539	117
27540	117
27541	117
27542	117
27543	117
27544	117
27545	117
27546	117
27547	117
27548	117
27549	117
27550	117
27551	117
27552	117
27553	117
27554	117
27555	117
27793	117
27794	117
27795	117
27796	117
27797	117
27810	117
27908	163
28228	135, 136, 227
28229	135, 136, 219, 227
28230	135, 136, 219, 277
28536	178
28538	178
28541	178
28612	226
28632	226
29424	168
29595	126, 135, 136, 227
30902	136
31609	214
31772	225
31776	225
31800	214
32054	129
32118	126, 135, 136, 227
32136	136
32325	225
32698	126, 135, 136, 227
32699	227
32937	69
32976	163
33439	227
33769	163
33853	229
34136	227
34251	226
34331	128
34479	136
34510	135, 136, 219, 227
34511	219, 227
34607	49, 158, 203
34698	129
34755	135, 136, 219, 227
34756	219, 227
34758	126, 135, 136, 227
34806	219
34807	219
34808	219
36352	172, 173
36469	219
36578	129
37368	219
37592	163
37907	59
38279	172
38597	219
38839	214
38840	214
38841	192, 214
38904	226
38909	225
38953	219
38954	219
39448	126
39610	191, 213
39611	191, 213
40063BL2	230
41224	135, 136
41226	135, 136
41291	163
42052	177, 178
43468	172
43562	219
43563	219
43888	134
43892	134, 136
44026	172
44119	177
44148	129
44195	129
44195	129
44457	219
44458	219
47484	18, 160
47955	24
48625	180, 200
49611	179, 202
50392	219
50449	135, 136
51100	178
51678	177
51695	177
52038	169
52871	183, 211
60796	212
61217	230
61243	229
61373	183, 211
61405	183, 211
61681	183, 211
62908	166
62909	167
62910	167
62911	167
63106	129
201454	135, 219, 227
201912	172
201913	172
201916	172

201917	172, 173	213015	165	304802	18	518483	23
201920	172	213299	22, 24	305085	108, 149	518484	23
201923	136, 219, 227	213896	229	306905	26, 139	518485	23
202621	170	214903	111	308472	18, 160	518486	23
202817	106, 158, 193	215009	181, 204	309111	216	518487	23
204141	170	215128	162	309119	219	518488	23
204928	162	215703	219	309120	219	518489	23
205049	192, 214	215844	171	310248	177	518490	23
205050	192, 214	216884	106, 158	310249	177	518491	23
205058	183, 211	216884	193	310810	18, 160	518492	23
205059	183, 211	217687	183, 211	310832	18, 160	518493	23
205060	183, 211	217791	18, 160	310840	18, 160	518494	23
205061	183, 211	218098	183, 211	313342	178	518495	23
205101	183, 211	218099	183, 211	313575	22, 24	518495	24
205377	129	218163	171	314386	180, 200	518496	23
205378	97, 129	218174	180, 200	314548	169	518497	23
205776	170	218504	183, 211	314651	24	518498	23
206386	183, 211	221378	178	314729	179, 202	518499	23, 24
206391	6, 184, 212	221476	66	440384	27	518501	23
206392	184, 212	222029	110	440533	180, 200	518527	23
206437	125, 177	222030	110	501153	27	518530	23
206457	178	222618	194, 211	511410	27	518534	23
206459	177, 178	223018	168	511413	27	518535	23
206629	183, 211	223196	203	513925	186, 209	518536	23
206803	106, 158, 193	300871	229	513926	186, 209	518537	23
207025	177, 178	302018	177	513927	186, 209	518542	23, 139
207026	177, 178	302019	177	513990	10	518582	27
207027	177, 178	302021	177	514644	186, 209	518583	27
207030	177, 178	302023	177	514645	186, 209	518584	27
207031	177, 178	302024	178	514646	186, 209	518896	27
207039	177, 178	302025	178	514647	186, 209	518897	27, 92
207436	230	302026	177, 178	514648	186, 209	518898	27, 92
207561	169	302027	177, 178	515686	180, 200	518899	27
208160	183, 211	302028	177	516159	180, 200	518900	27, 92
208349	178	302029	177	516160	180, 200	518901	27, 92
208350	178	302030	177, 178	516941	108	518902	27
208369	172	302031	177, 178	516942	108	519067	27
208370	172	302032	177, 178	517145	22, 24	519068	27
208406	225	302249	192, 214	518356	23	519097-1	50, 71
208629	173	302340	163	518472	23	519097-2	50, 71
208675	163	302401	177	518473	23	519097-3	50, 71
209199	108	302482	163, 227	518474	23	519097-4	50, 71
209200	108	302483	227	518476	23	519097-5	50, 71
209201	110	302592	177, 178	518477	23	519097-6	50, 71
211051	111	302593	177, 178	518478	23	519097-7	50, 71
211407	216	302595	177, 178	518480	23, 24	519151	27
213013	165	302941	192, 214	518481	23	519152	27, 48
213014	165	303785	227	518482	23	519153	27, 48

519154	27, 28, 48
519155	27
519156	27, 42, 47
519157	27, 42, 47
519158	27
519159	27, 48
519378	48
522888	10
522889	10
522890	10
522891	10
522892	10
522893	10
522894	10
522896	10
522897	10
522898	10
522899	10
522900A	10
522901	10
522902	10
525216	3, 4
525217	3, 4
525218	3, 4
526908-1	11, 157
526908-2	11, 157
526908-3	11, 157
526908-4	11, 157
526908-5	11, 157
526908-6	11, 157
526908-7	11, 157
526908-8	11, 157
527045	7
527046	7
527048	8
527049	7
527050	8
527051	8
527052	8
527055	8
527056	7
527057	8
527058	8
527061-1	7, 8
527061-2	7
528150	179, 202
528766	23
528767	23
528768	23
528769	23, 24
528770	23
528771	23
528772	23
528773	26
528774	26
528776	26
528853	183, 211
528856	183, 211
528858	183, 211
528859	183, 211
528861	183, 211
528863	183, 211
528868	183, 211
529636	8
529637	8
529638	8
532174	7
532195	7
535936	197
536172	7, 8
536174	7
536176	7
536178	7
536181	7
536186	7, 8
536187	7, 8
536254	7
536255	7
536265	7
536582	8
536583	8
536584	8
536585	8
536586	8
536587	8
536588	8
536589	8
536590	8
536594	8
536595	8
536596	8
536608	8
536611	8
536612	8
536613	8
537757-4	10
537757-5	10
537757-6	10
537757-7	10
538592	229
540231	179, 202
540232	179, 202
543284	179, 202
543751	184, 208
543752	184, 208
543885	197
543887	197
549578	23, 24
549579	23
549596	23
549597	23
549598	23
552948	70
553516	179, 202
553913	197
553915	197
553990	197
553991	197
553993	197
554654	197
556889	197
557281	197
557282	197
557283	197
557479	97, 129
557480	97, 129
557510	197
557511	197
557553	197
557554	197
558181	197
558382	179, 202
558569	197
558570	197
558571	197
558572	197
558573	197
561949	179, 202
563197	196
567611	3
567613	3
567614	3
567617	3
567618	3
567619	3
567620	3
567621	3
567622	3
567623	3
567649	3
567840	23
572913	180, 200
573295	223
573296	223
573810	227
573825	227
573834	227
577564	131
577565	131
577566	131
577567	131
577568	131
577569	131
577570	131
577571	131
577572	131
577573	131
577574	131
581340	22, 24
J-29109-J	183, 211
J-47399	198
PA7	133

WHAT WE LIKE MOST ABOUT TECHNICIANS IS THEIR WORK ETHIC. Technicians are problem solvers who aren't afraid of sweat on their brow and grease on their hands. They provide high quality services that demand high quality tools. When they need a reliable tool, they know they can depend on OTC tools to deliver.



Owatonna Tool Company for the long haul — proudly

designing and manufacturing American specialty service tools, diagnostics and shop equipment since 1925.

OTC TOOLS ARE SOLD THROUGH DISTRIBUTORS, RESELLERS AND RETAILERS. LEARN MORE AT OTCTOOLS.COM.

WHERE TO BUY

LOOKING FOR AN OTC PRODUCT?

OTC tools and equipment are sold through distribution partners, resellers and at retailers. Visit OTCTools.com to learn more.

DISTRIBUTORS

Canada Canada Canada

RETAIL

U.S. & Canada U.S. & Canada U.S. & Canada U.S. & Canada

MOBILE DISTRIBUTORS

HEAVY DUTY DISTRIBUTORS



BOSCH AUTOMOTIVE SERVICE SOLUTIONS INC.
28635 MOUND ROAD
WARREN, MI 48092 USA

TECH SERVICES

PHONE 800 533 6127
FAX 800 955 8329

CUSTOMER SERVICE

PHONE 800 533 6127
FAX 800 283 8665

www.otctools.com