



## Interactive software

### Intelligent and predictive alignment workflow

Avoid guessing by using this rapid and reliable system for detecting problems and damage:

-  **Compensate:** measurement ok and compensated with no notification
-  **Warn:** wheel imperfections are compensated and user is warned
-  **Alert:** critical errors are detected and corrective actions are displayed

## Easy, intuitive workflow

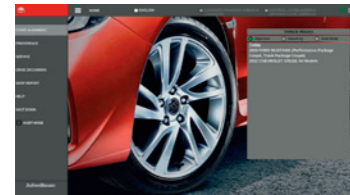

# 01

**SELECT VEHICLE**

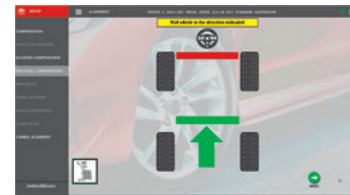

# 02

**MEASURE**



# 03

**ADJUST**



# 04

**PRINT REPORT**

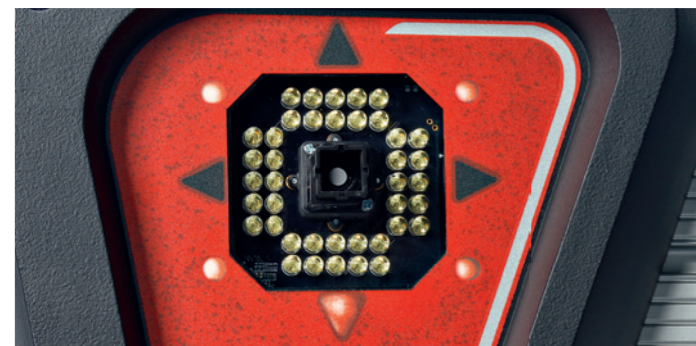

## VODI™

Our Vehicle Orientation Directional Indicator guides and speeds up your technician operations throughout the entire measurement procedure.

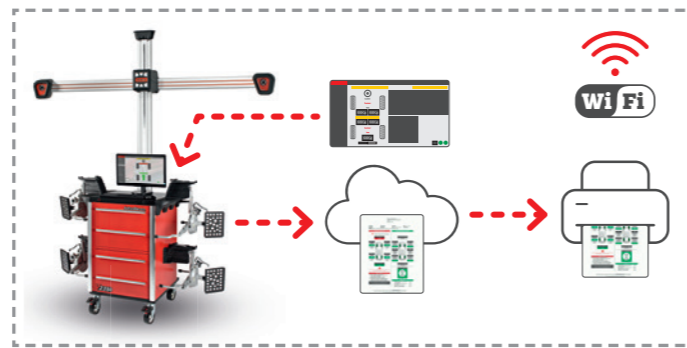

## Connect it and get more

- Online connectivity automatically downloads specifications and software updates
- With our favourable specs subscription plans you are always updated with the latest vehicle models
- Cloud based printing option: retrieve and print your reports from any internet connected PC or mobile device
- Wireless remote display (tablet) supported

## NextGen v23

- 40+ Languages
- Integrated Operation Help
- Multiple Units of Measure
- Vehicle Specifications (35+ years)
- Ride Height Specifications
- Custom Vehicle Specifications
- Advanced Customer Database
- Steering Angle Reset Instruction
- 3-D Animation Help
- Multiple Printout Formats
- ADAS Documentation
- Vehicle History
- Undercar Repair Information
- Save Print Reports to Cloud
- Network Updates for Software and Specs
- VODI™ - Vehicle Orientation Directional Indicator
- Remote Display Support
- Automatic Lift Tracking
- Romess Inclinator
- TIP (Automatic Ride Height Measurement)
- Custom Live Reporting
- Compensate/Warn/Alert
- Fast Rolling Compensation and Caster
- Non-stop compensation
- Live Thrust Angle
- Live Caster, Camber & Toe - Turntables
- Live Caster, Camber & Toe - Elevated
- Toe Out on Turns and Max. Turn
- Caster & SAI - Turntables
- Elevated Alignment Adjustment
- Alignment Reading Zoom
- EZ-Toe
- A-Arm Adjust
- Live Cradle Adjustment
- Drag Link Adjustment
- Single Tie Rod Adjustment
- Live Vehicle Dimensions
- 2-wheels Alignment
- Wheels Off (EZ-Access)
- Cross Diagonals
- Rolling Radius
- Advanced Vehicle Dimensions
- Audit mode



# DISCOVER THE PERFECT COMBINATION OF TECHNOLOGY AND SIMPLICITY

## INTRODUCING THE V2380 PROFESSIONAL WHEEL ALIGNMENT SYSTEMS



**JohnBean™**

[www.johnbean.com/en/distributor](http://www.johnbean.com/en/distributor)

Part of the machines is illustrated with optional extras which are available at extra cost. Technical modifications reserved. Cod. 2009 101 - 09/2020



Snap-on Total Shop Solutions offers a wide range of garage equipment solutions for workshops, garages, car dealers and tyre shops, thanks to the specific solutions provided by its portfolio of premium brands.

**JohnBean™**

# V2380

## THE ALIGNMENT RACEHORSE

Designed for Specialty Shops that want a professional quality aligner with proven accuracy

### 01

#### FAST TO USE

- AC400 rim touchless clamps
- High speed video camera system
- Intelligent software workflow
- Compensate - Warn - Alert
- Automatic vehicle height tracking

### 02

#### FLEXIBLE

- Audit mode
- Mobility kit
- Short bay
- Remote screen supported
- Remote printing
- Online specs updates

### 03

#### FOR THE SPECIALIST

- Ride height measurement
- Advanced dimensions
- ADAS info
- EZ-Toe
- EZ-Access (Wheels off)



#### AC400

Clamp made fast, safe, easy and accurate

- Grab the tyre, without touching the rim
- Single fast-action knob for easy clamping
- Light, balanced, easy to handle
- Fits a full range of tyres (wheels up to 39") without need of additional accessories



#### Automatic Lift Tracking

We use the most advanced camera system

Cameras follow the height of the vehicle avoiding the need of adjusting the aligner while moving the lift. Alignment readings are ready in less than two minutes!

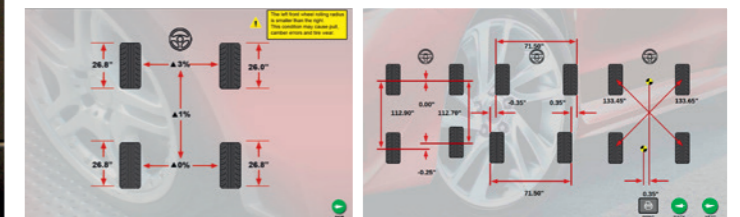

#### Advanced Dimensions

Rolling Radius and Cross Diagonals

Chassis data as diagonals, track width and wheelbase indicate collision damage. Rolling Radius measurement and tyre size mismatch are common contributors to pull problems.

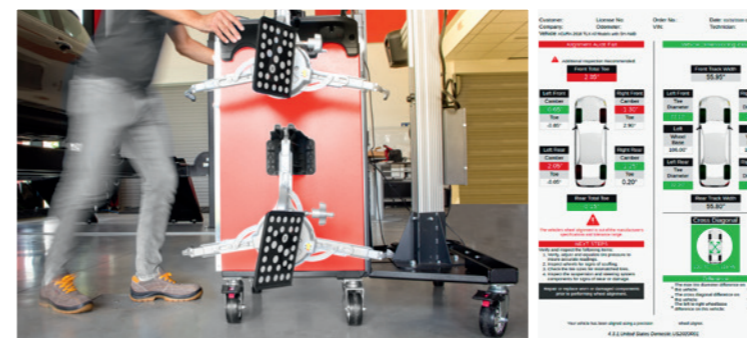
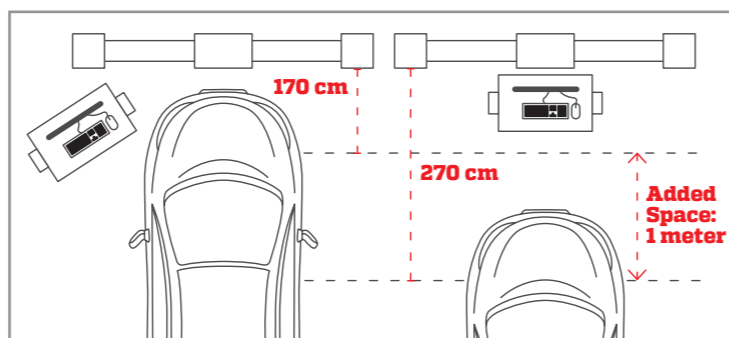

#### Two machines in one

Move the aligner and use it in different service bays

- The Mobility Kit allows you to move the complete aligner to the necessary bay and use it with no need of calibration

#### Audit and adjust with the same unit!

- Audit mode quickly identifies if a car needs adjustment
- In less than a minute a simple printout is showing Camber, Total Toe, and Thrust angles
- Improve alignment sales with Audit mode!

#### Ride Height

(Optional TIP target)

Many of today's vehicles have Toe, Camber, and even Caster specs that are calculated with respect to the vehicle's ride height. With our optional TIP target the aligner is able to measure these values faster and more accurately than a manual measurement: it reduces the time needed for ride height measurement, ensuring the best possible alignment results.

